



# airFiber<sup>®</sup> X

2.4 GHz, 3 GHz, 4 GHz, 5 GHz  
Carrier Backhaul Radio

Model: AF-2X, AF-3X, AF-4X, AF-5X

USER GUIDE



## Table of Contents

---

<b>Chapter 1: Overview</b> .....	1
Introduction .....	1
Package Contents .....	1
airFiber Configuration Interface System Requirements .....	1
Hardware Overview .....	1
<b>Chapter 2: Installation</b> .....	3
Installation Requirements .....	3
Installation Overview .....	3
Connecting Power over Ethernet .....	3
airFiber Configuration .....	4
Hardware Installation .....	5
Alignment .....	9
Installer Compliance Responsibility .....	10
<b>Chapter 3: Navigation</b> .....	11
Accessing the airFiber Configuration Interface .....	11
Product Verification .....	12
Interface Tabs .....	12
<b>Chapter 4: Main Tab</b> .....	13
Status .....	13
Ethernet .....	15
Monitor .....	15
<b>Chapter 5: Wireless Tab</b> .....	17
Basic Wireless Settings .....	17
Frequency Settings .....	19
Wireless Security .....	19
<b>Chapter 6: Network Tab</b> .....	21
Management Network Settings .....	21
<b>Chapter 7: Advanced Tab</b> .....	23
Wireless Settings .....	23
DATA Port Ethernet Settings .....	24
MGMT Port Ethernet Settings .....	25

<b>Chapter 8: Services Tab</b> .....	27
Ping Watchdog .....	27
SNMP Agent .....	28
Telnet Server .....	29
NTP Client .....	29
Dynamic DNS .....	29
System Log .....	29
Device Discovery .....	29
<b>Chapter 9: System Tab</b> .....	31
Firmware Update .....	31
Device .....	32
Date Settings .....	32
System Accounts .....	32
Miscellaneous .....	32
Location .....	33
Device Maintenance .....	33
Configuration Management .....	33
<b>Chapter 10: Tools</b> .....	35
Align Antenna .....	35
Discovery .....	36
Ping .....	36
Traceroute .....	36
airView .....	36
<b>Appendix A: Specifications</b> .....	41
<b>Appendix B: AF-5X and airFiber Multiplexer</b> .....	45
airFiber X Compatibility .....	45
Installation Requirements .....	45
Hardware Overview .....	45
Configure the airFiber 5X Radio .....	46
Hardware Installation .....	46
<b>Appendix C: Listen Before Talk</b> .....	51
Introduction .....	51
Unrestricted Protocol Description .....	51
Threshold Detection To Determine Occupancy .....	51
Action Taken When Occupancy is Determined .....	51
Opportunities for Other Transmitters to Operate .....	52



<b>Appendix D: Safety Notices</b> .....	53
Electrical Safety Information .....	53
<b>Appendix E: Warranty</b> .....	55
Limited Warranty .....	55
<b>Appendix F: Compliance Information</b> .....	57
Installer Compliance Responsibility .....	57
FCC .....	57
Industry Canada .....	59
RF Exposure Warning .....	61
Australia and New Zealand .....	61
CE Marking .....	62
airFiber AF-4X Compliance .....	62
Frequency Ranges and Power Levels per Country/Region .....	63
RoHS/WEEE Compliance Statement .....	69
<b>Appendix G: Declaration of Conformity</b> .....	71
<b>Appendix H: Contact Information</b> .....	73
Ubiquiti Networks Support .....	73



# Chapter 1: Overview

## Introduction

Thank you for purchasing the Ubiquiti Networks® airFiber® X Carrier Backhaul Radio. This User Guide is for use with the following models:

Model	Description	Operating Frequency*
AF-2X	2.4 GHz Carrier Backhaul Radio	2400 - 2500 MHz
AF-3X	3 GHz Carrier Backhaul Radio	3300 - 3900 MHz
AF-4X	4 GHz Carrier Backhaul Radio	4940 - 4990 MHz
AF-5X	5 GHz Carrier Backhaul Radio	5150 - 5925 MHz

\*Depends on Regulatory Region. Refer to **“Specifications” on page 41** for more information.

This User Guide provides installation instructions, explains how to set up an airFiber link, and shows how to access and use the airFiber Configuration Interface.

**Note:** Throughout this User Guide, *airFiber X radio* refers to all models listed above. Unless noted otherwise, illustrations for a specific model are applicable to all airFiber X radio models and accessories.

## Package Contents

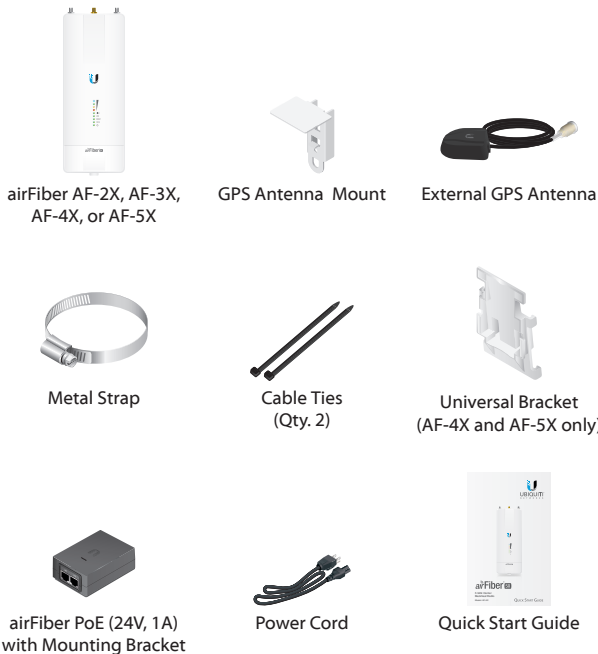

TERMS OF USE: Ubiquiti radio devices must be professionally installed. Shielded Ethernet cable and earth grounding must be used as conditions of product warranty. TOUGH Cable™ is designed for outdoor installations. It is the customer's responsibility to follow local country regulations, including operation within legal frequency channels, output power, and Dynamic Frequency Selection (DFS) requirements.

## airFiber Configuration Interface System Requirements

- Microsoft Windows 7, Windows 8; Linux; or Mac OS X
- Java Runtime Environment 1.6 (or above)
- Web Browser: Mozilla Firefox, Apple Safari, Google Chrome, Microsoft Edge, or Microsoft Internet Explorer 11

## Hardware Overview

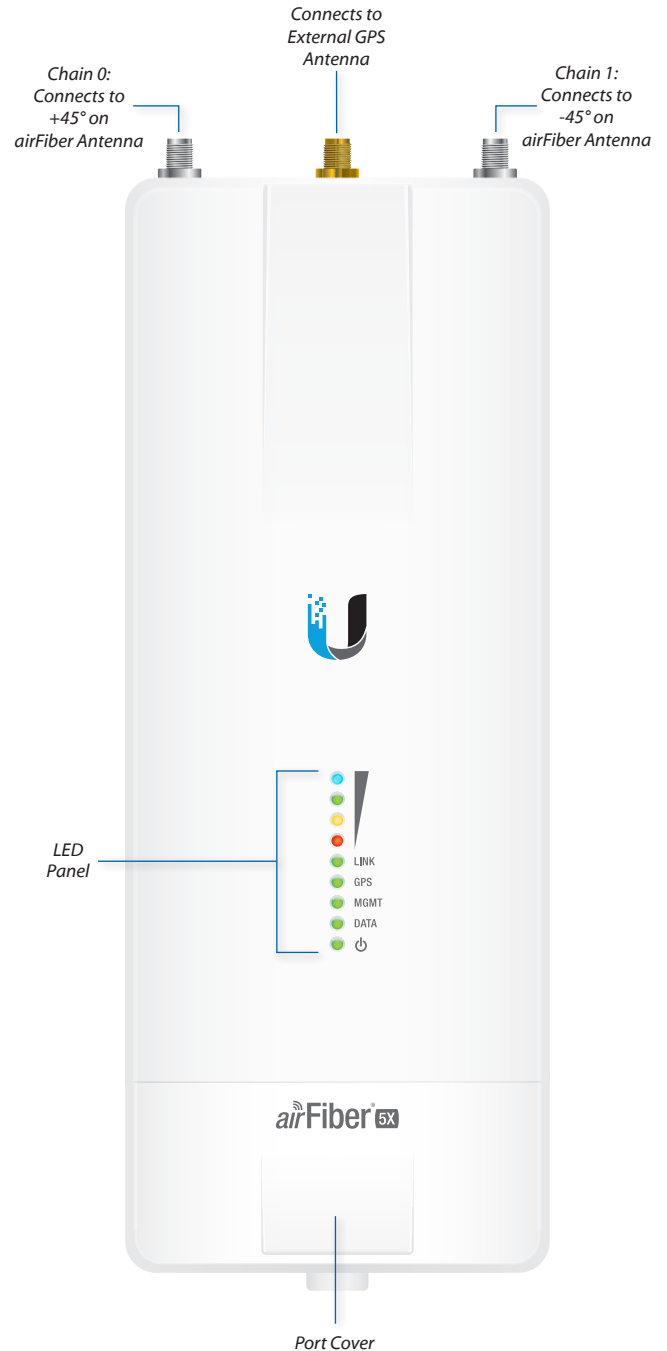

## Ports

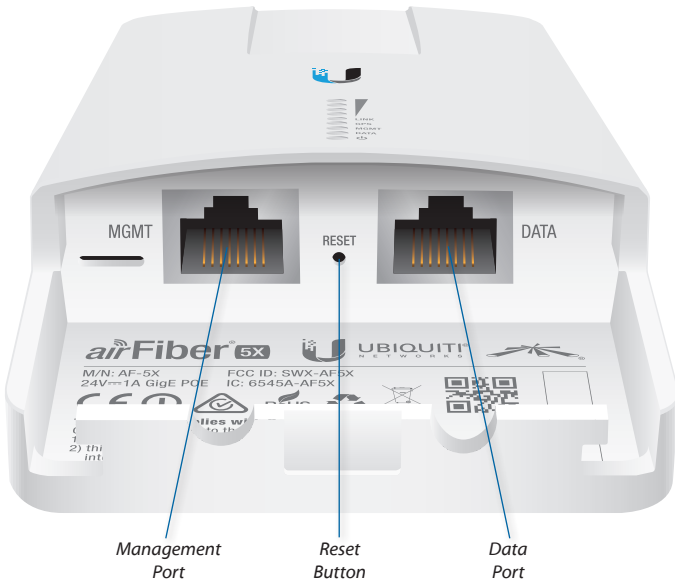





**Management Port** 10/100 Mbps, secured Ethernet port for configuration. *In-Band Management* is enabled by default in the airFiber Configuration Interface. When *In-Band Management* is disabled, the *MGMT* port is the only port that can monitor, configure, and/or update firmware.

**Reset Button** To reset to factory defaults, press and hold the *Reset* button for more than 10 seconds while the device is already powered on.

**Data Port** Gigabit PoE port for handling all user traffic and powering the device.

## LEDs

### Signal LEDs

-  **Signal 4** LED will light blue when on.
-  **Signal 3** LED will light green when on.
-  **Signal 2** LED will light yellow when on.
-  **Signal 1** LED will light red when on.

**Bootup to airOS** When powering on, the *Power*, *GPS*, *LINK*, and *Signal 1-4* LEDs light on. Once the CPU code takes over, the *GPS*, *LINK*, and *Signal 1-3* LEDs turn off. *Signal 4* LED remains on to indicate the boot sequence is underway.

**Initializing airFiber Software** When the airFiber application begins to boot under airOS, the *Signal 4* LED goes from solidly on to a 2.5 Hz flash. This continues until the airFiber X radio is fully booted.

**Signal Level** Once fully booted, the *Signal 1-4* LEDs act as a bar graph showing how close the airFiber X radio is to ideal aiming. This is auto-scaled based on the link range, the antenna gains, and the configured TX power of the remote airFiber X radio. Each *Signal* LED has three possible states: *On*, *Flashing*, and *Off*. All *Signal* LEDs would be solidly on in an ideal link. If the link has a 1 dB loss, the *Signal 4* LED will flash; a 2 dB loss and the *Signal 4* LED will turn off. The full bar graph LED states are shown below.

dB loss	0	-1	-2	-3	-4	-5	-6	-7	-8	-9	-10	-11	-12	-13
Signal 4 (Blue)	1	F	0	0	0	0	0	0	0	0	0	0	0	0
Signal 3 (Green)	1	1	1	F	0	0	0	0	0	0	0	0	0	0
Signal 2 (Yellow)	1	1	1	1	1	F	F	0	0	0	0	0	0	0
Signal 1 (Red)	1	1	1	1	1	1	1	1	1	1	F	F	F	0

0 = Off, 1 = On, F = Flashing

### Additional LEDs

LED	State	Status
LINK	Off	RF Off
	Short Flash*	Syncing
	Normal Flash*	Beaconing
	Long Flash*	Registering
	On	Operational
GPS	Off	No GPS Synchronization
	Normal Flash*	Non-Operational (Weak Signal)
	On	Operational (Strong Signal)
MGMT	Off	No Ethernet Link
	On	Ethernet Link Established
	Random Flashing	Ethernet Activity
DATA	Off	No Ethernet Link
	On	Ethernet Link Established
	Random Flashing	Ethernet Activity
	Off	No Power
	On	Powered On

\* Short Flash (1:3 on/off cycle)  
 Normal Flash (1:1 on/off cycle)  
 Long Flash (3:1 on/off cycle)

## Chapter 2: Installation

### Installation Requirements

The airFiber radio operates only with the antennas listed below:

airFiber Radio	airFiber X Antenna	RocketDish + Conversion Kit
AF-2X	AF-2G24-S45	n/a
AF-3X	AF-3G26-S45	n/a
AF-4X	AF-5G30-S45 AF-5G34-S45	RD-5G30 + AF-5G-OMT-S45 RD-5G34 + AF-5G-OMT-S45
AF-5X	AF-5G23-S45 AF-5G30-S45 AF-5G34-S45	RD-5G30 + AF-5G-OMT-S45 RD-5G34 + AF-5G-OMT-S45

See the antenna's Quick Start Guide for antenna installation instructions.

### Other Requirements

- Clear line of sight between airFiber X radios
- Clear view of the sky for proper GPS operation
- Vertical mounting orientation
- Mounting point:
  - At least 1 m below the highest point on the structure
  - For tower installations, at least 3 m below the top of the tower
- Ground wires – min. 10 AWG (5 mm<sup>2</sup>) and max. length: 1 m. As a safety precaution, ground the airFiber X radio to grounded masts, poles, towers, or grounding bars.
  - ! **WARNING: Failure to properly ground your airFiber X radio will void your warranty.**
- (Recommended) 2 Outdoor Gigabit PoE surge protectors
  - 📄 **Note:** For guidelines about grounding and lightning protection, follow your local electrical regulatory codes.
- Outdoor, shielded Category 6 (or above) cabling and shielded RJ-45 connectors are required for all wired Ethernet connections.

### Installation Overview

We recommend to configure your paired airFiber X radios before site installation. The overview below summarizes the installation procedure, and the subsequent sections provide detailed installation information:

- Connect the *airFiber PoE Adapter* to the *DATA* port, and connect your computer and the *MGMT* port.
- Configure the airFiber X radio.
- Install a ground wire and mount the airFiber X radio on an airFiber X antenna.
- At the installation site, install the airFiber X antenna with the mounted airFiber X radio (see the antenna's Quick Start Guide for installation instructions).

- Secure the ground wire and mount the GPS antenna.
- Establish and optimize the RF link.

### Connecting Power over Ethernet

1. Lift the release latch on the bottom of the airFiber X radio and slide the *Port Cover* off.



2. Connect an Ethernet cable to the *DATA* port.

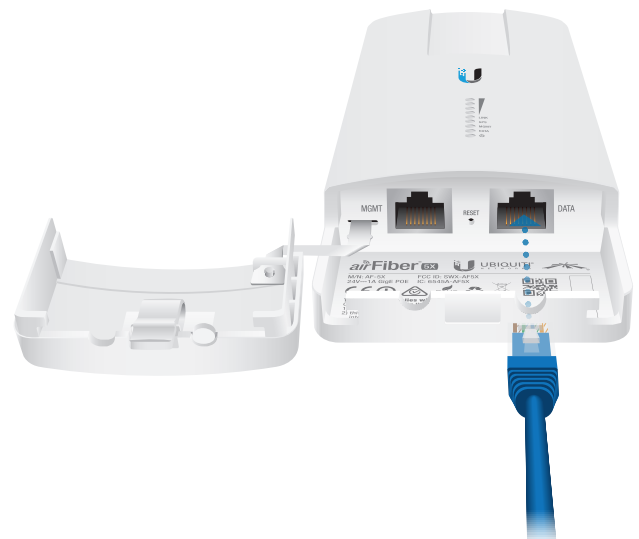

3. Connect the Ethernet cable from the *DATA* port to the Ethernet port labeled **POE** on the *airFiber PoE Adapter*.

- ! **WARNING:** Use only the included airFiber PoE adapter, Model **GP-H240-100G-4**. Failure to do so can damage the unit and void the product warranty.



4. Connect the *Power Cord* to the power port on the *airFiber PoE Adapter*. Connect the other end of the *Power Cord* to a power source.

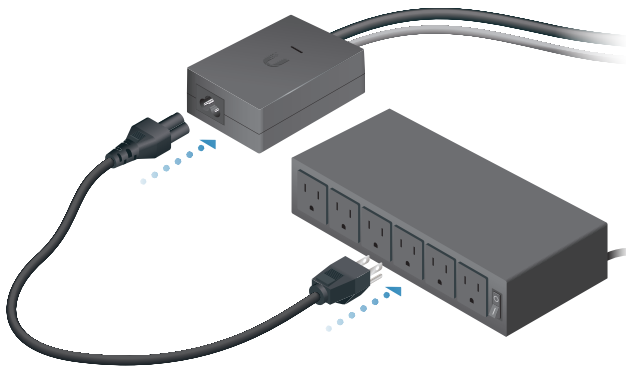

## airFiber Configuration

The instructions in this section explain how to access the airFiber Configuration Interface and configure the following settings:

- **Wireless Mode** Configure one airFiber X radio as the *Master* and the other as the *Slave*.
  - **Frequency Setting** The operating *Frequency* must be the same on both the Master and the Slave.
1. Connect an Ethernet cable from your computer to the *MGMT* port on the airFiber X radio.

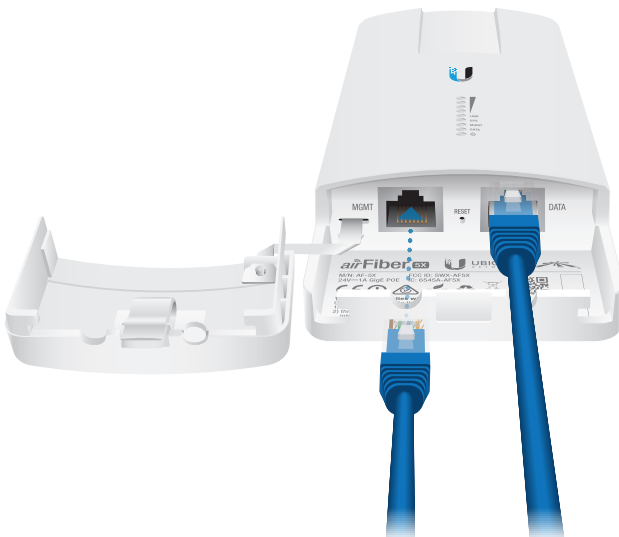

2. Configure the Ethernet adapter on your computer with a static IP address on the 192.168.1.x subnet.
3. Launch your web browser. Type **http://192.168.1.20** in the address field and press **enter** (PC) or **return** (Mac).



4. The login screen will appear. Enter **ubnt** in the *Username* and *Password* fields. Select your *Country* and *Language*. You must agree to the *Terms of Use* to use the product. Click **Login**.



**Note for models AF-2X, AF-3X, and AF-5X only:** U.S. product versions are locked to the U.S. Country Code to ensure compliance with FCC regulations.

5. Click the **Wireless** tab.

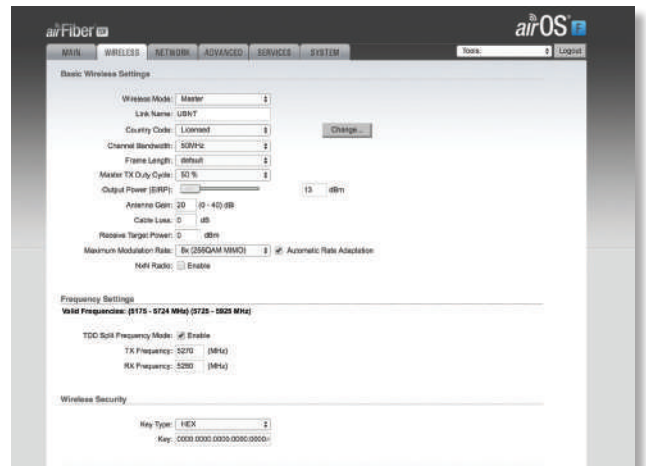

6. Configure the *Basic Wireless Settings*:
  - a. For one airFiber X radio, select **Master** as the *Wireless Mode*. For the other airFiber X radio, keep the default, *Slave*.
  - b. Enter a name in the *Link Name* field. This should be the same on both the Master and the Slave.
  - c. If needed, change the *Channel Bandwidth*, (*Master*) *Duty Cycle*, *Output Power*, *Cable Loss* (see Note below), and/or *Maximum Modulation Rate* settings.

**Note:** If you are using the airFiber AF-5X radio with an airFiber Multiplexer, perform the following additional steps:

- d. Set the *Cable Loss* to a value that includes the *additional loss* (in dB) due to the Multiplexer. The additional cable loss is (approximately):
  - **4 dB** for the AF-MPx4, or
  - **7 dB** for the AF-MPx8
- e. Enable the *NxN Radio* setting on each end of the link.

7. Configure the *Frequency Settings*. The selected *Frequency* must be the same on both airFiber X radios.
8. Configure the *Wireless Security*:
  - a. Select the *AES Key Type*, **HEX** or **ASCII**.
  - b. For the *Key* field:
    - **HEX** Enter 16 bytes (eight, 16-bit HEX values: 0-9, A-F, or a-f). You can omit zeroes and use colons, similar to the IPv6 format.
9. Click **Change** and then click **Apply**.
10. *In-Band Management* is enabled by default, so each airFiber X radio must have a unique *IP Address*. (If the airFiber X radios use the same *IP Address*, you may lose access to the airFiber X radios via the *DATA* ports.) Click the **Network** tab.

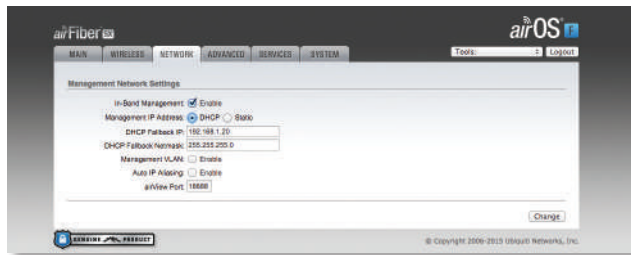

- a. For the *Management IP Address* option:
  - **DHCP** Keep the default, *DHCP*, to use DHCP reservation on your router to assign a unique *IP Address*.
  - **Static** Change the *IP Address*, *Netmask*, and other settings to make them compatible with your network.
- b. Click **Change** and then click **Apply**.

Repeat the instructions in the *airFiber Configuration* section on your other airFiber X radio. After you have configured the airFiber X radios, disconnect them and move them to your installation site.

## Hardware Installation

### Install a Ground Wire

1. Remove the nut from the *Ground Bonding Point* located on the back of the airFiber X radio.

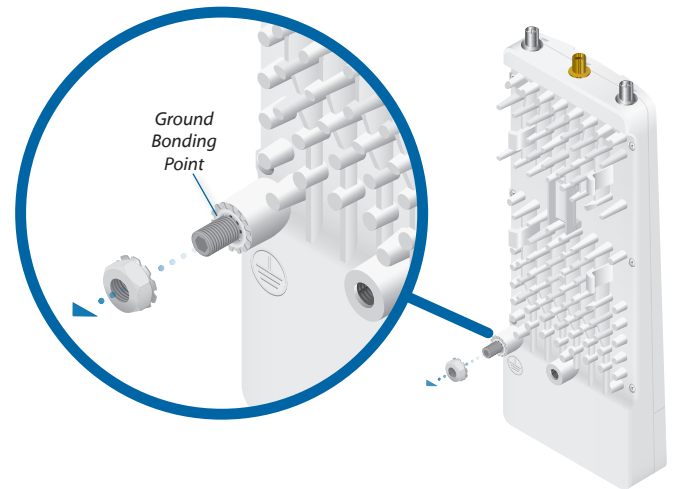

2. Attach a ground wire (min. 10 AWG or 5 mm<sup>2</sup>) to the lug and replace the nut to secure the wire.



3. At the installation site, secure the other end of the ground wire to a grounded mast, pole, tower, or grounding bar.

**!** **WARNING:** Failure to properly ground your airFiber X radio will void your warranty.

**📄** **Note:** The ground wire should be as short as possible and no longer than one meter in length.



## Mount to an Antenna

The airFiber X radio can be mounted to the antenna(s) listed in **“Installation Requirements” on page 3**.

The airFiber X Antenna (AF-5G30-S45) is shown in the following steps:

1. Attach the airFiber X radio to the antenna by aligning the four tabs on the back of the radio with the slots of the radio mount. Then slide the radio down to lock it into place.

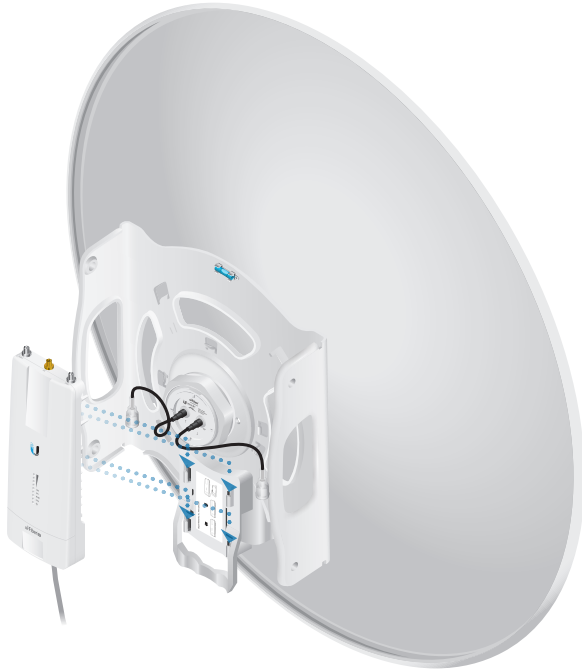

2. Attach the RF connectors to the radio in this combination:  $+45^\circ$  to *Chain 0* and  $-45^\circ$  to *Chain 1*. Then slide the jackets over the RF connectors to protect them.



3. Attach the *External GPS Antenna* (included with the radio) to the RF connector labeled *GPS* on the radio.



4. Attach the protective shroud.
  - a. Align the hash mark on the top of the shroud with the notch on the dish antenna.
  - b. Rotate the shroud clockwise until it locks into place.





## Mount to a RocketDish Antenna

This section applies only to the airFiber AF-4X and AF-5X radios.



**Note:** If you are mounting the AF-4X or AF-5X on a RocketDish equipped with the AF-5G-OMT-S45 Conversion Kit, the *Universal Bracket* is not needed. Refer instead to the *Mount to an airFiber X Antenna* section for instructions.

The RocketDish RD-5G30 antenna is shown in this section:

1. Position the *Universal Bracket* over the back of the airFiber radio with the bracket clips over the radio mounting tabs.
2. Push the bracket onto the airFiber radio until it locks in place.

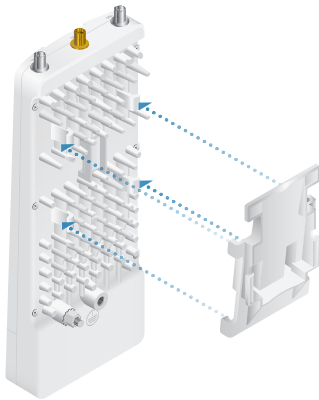

3. Attach the airFiber radio to the RocketDish mounting bracket.
  - a. Align the mounting tabs on the Universal Bracket with the RocketDish mounting bracket.
  - b. Slide the airFiber radio down to lock it into place.



## Mount the External GPS Antenna

Locate a mounting point that has a clear view to the sky, and is above and as far away as possible from the airFiber X radio.

1. Attach the *GPS Antenna Mount* to the pole using the metal strap, or attach it to a wall using the appropriate fasteners (not included).

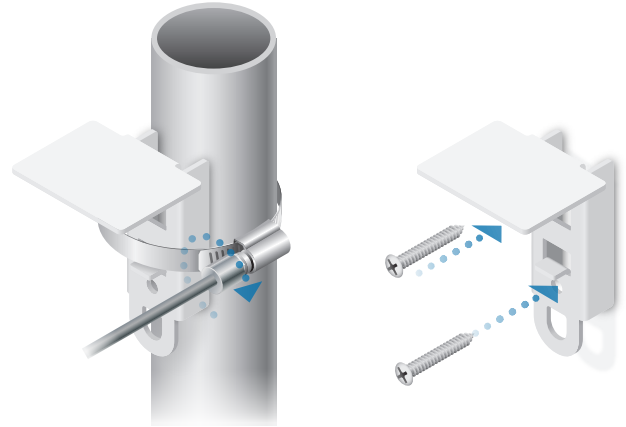

2. Place the *External GPS Antenna* on the mount.



3. Secure the cable of the *External GPS Antenna* to the mount with a *Cable Tie*.



### Connecting Power over Ethernet

1. Lift the release latch on the bottom of the airFiber X radio and slide the *Port Cover* off.



2. Connect an outdoor, shielded Ethernet cable to the *DATA* port.



3. Connect the other end of the cable from the *DATA* port to the Ethernet port labeled **POE** on the *airFiber PoE Adapter*.

**! WARNING:** Use only the included *airFiber PoE Adapter*, Model: **GP-H240-100G-4**. Failure to do so can damage the unit and void the product warranty.

4. Connect an Ethernet cable from your LAN to the adapter's **LAN** port.
5. Connect the *Power Cord* to the adapter's power port. Connect the other end of the *Power Cord* to a power outlet.

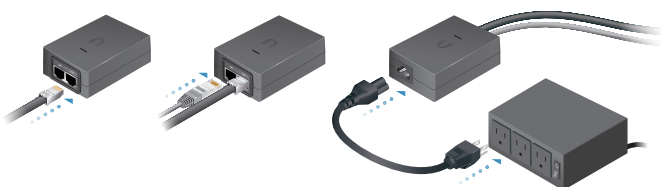

### Mount the PoE Adapter (Optional)

1. Remove the *Mounting Bracket* from the adapter, place the bracket at the desired location, and mark the two holes.
2. Pre-drill the holes if necessary, and secure the bracket using two fasteners (not included).
3. Align the adapter's slots with the tabs of the *Mounting Bracket*, and then slide the adapter down.

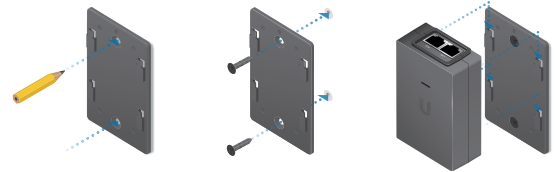

### Surge Protection

For added protection, install two surge suppressors, such as the Ubiquiti Ethernet Surge Protector, model ETH-SP, at the end of each link. Install the first surge protector within one meter of the airFiber *DATA* port, and install the second surge protector at the ingress point of the location housing the wired network equipment.

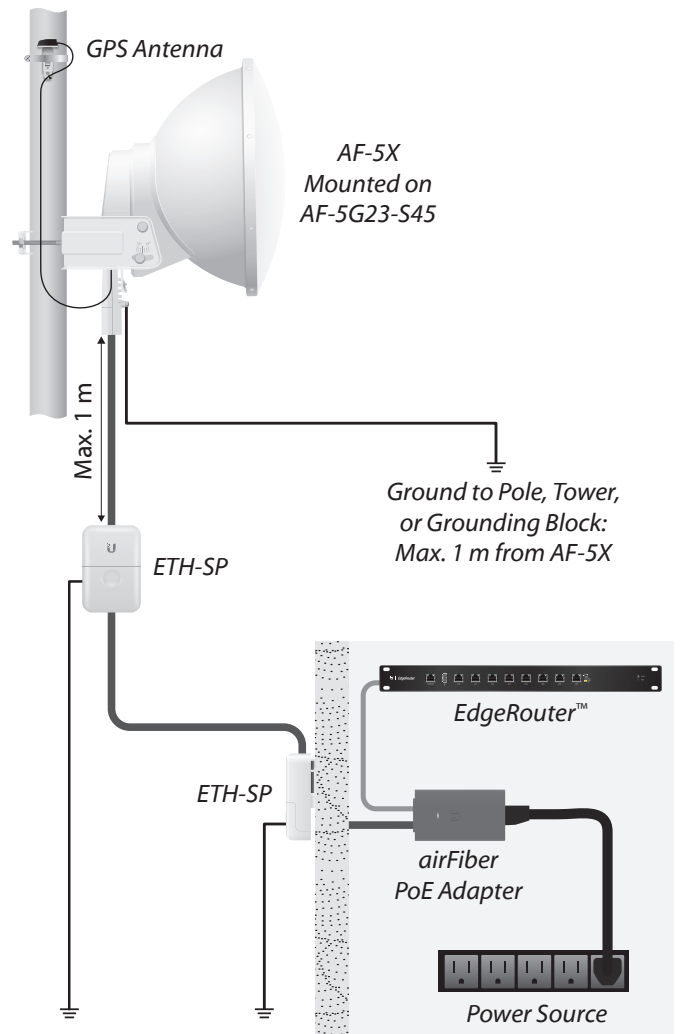

# Alignment

## Tips

- To accurately align the airFiber X radios for best performance, you **MUST** align only one end of the link at a time.
- You may need to use additional hardware to compensate for issues such as the improper orientation of a mounting pole or significant elevation differences between airFiber X radios.

**Note:** If you have AF-5X radios mounted in an airFiber Multiplexer (AF-MPx4 or AF-MPx8), perform the procedure in **“Establishing a Link” on page 9** on one radio only. This will help ensure maximum success in registrations. Refer to **“AF-5X and airFiber Multiplexer” on page 43** for additional information on airFiber Multiplexer installation.

## Establishing a Link

Adjust the positions of the *Master* and the *Slave* to establish a link.

**Note:** The *Master* must be aimed first at the *Slave* because the *Slave* does not transmit any RF signal until it detects transmissions from the *Master*.

**Note:** The airFiber X antenna AF-5G30-S45 is shown in the following steps. Instructions for other antennas are similar. For complete details, refer to the Quick Start Guide for your specific model.

1. **Master** Visually aim the *Master* at the *Slave*. To adjust the *Master's* position:
  - a. Loosen the four pole clamp nuts, and rotate the airFiber antenna on the pole to align the azimuth.

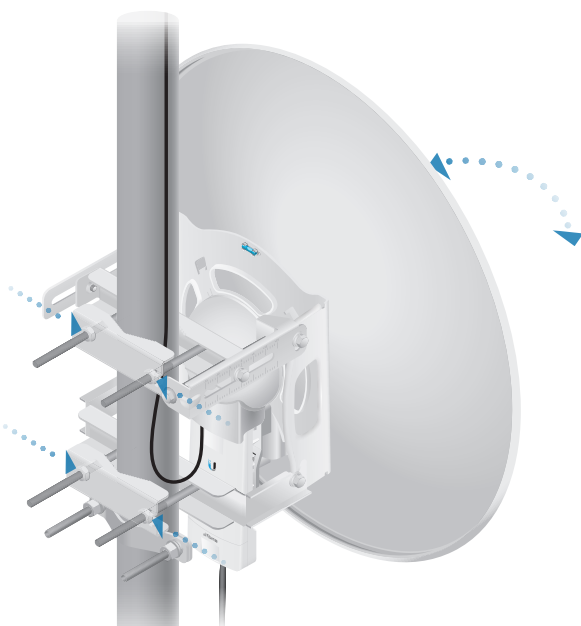

- b. Loosen the six elevation bolts, and use the hex nut on the elevation rod to adjust the elevation.

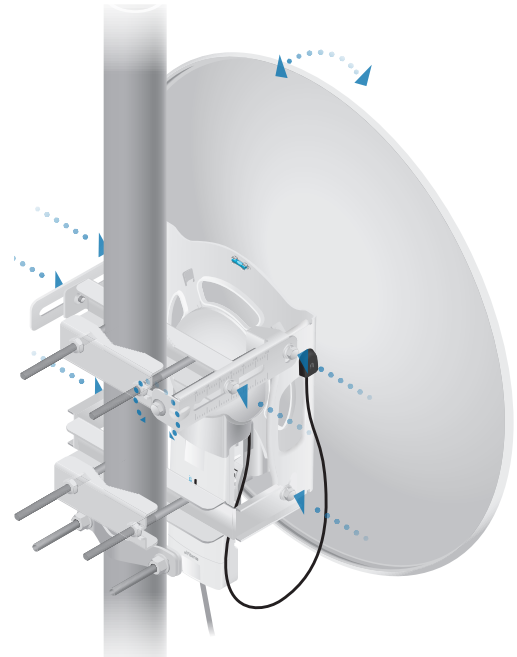

**Note:** Do NOT make simultaneous adjustments on the *Master* and *Slave*.

2. **Slave** Visually aim the *Slave* at the *Master*. To adjust the *Slave's* position:
  - a. Loosen the four pole clamp nuts, and rotate the airFiber antenna on the pole to align the azimuth.
  - b. Loosen the six elevation bolts, and use the hex nut on the elevation rod to adjust the elevation.
3. Check to see if a link is established. Ensure that the *LINK* LED is solidly lit green and the *Signal* LEDs of the *Slave* are displaying signal levels.



4. **Slave** Aim the *Slave* at the *Master* to achieve the strongest signal level on the *Master*.

**Note:** Refer to **“Signal LEDs” on page 2** for details on the signal values.

**Note:** Maximum signal strength can best be achieved by iteratively sweeping through both azimuth and elevation.

5. **Master** Aim the *Master* at the *Slave* to achieve the strongest signal level on the *Slave*.
6. Repeat steps 4 and 5 until you achieve an optimal link, with all four *Signal* LEDs solidly lit. This ensures the best possible data rate between the airFiber X radios.
7. Lock the alignment on both airFiber antennas by tightening all the nuts and bolts.
8. Observe the *Signal* LEDs of each airFiber X radio to ensure that the values remain constant while tightening the nuts and bolts. If any LED value changes during the locking process, loosen the nuts and bolts, finalize the alignment of each airFiber antenna again, and retighten the nuts and bolts.

Refer to the following chapters of this User Guide for details on the airFiber Configuration Interface:

- **“Main Tab” on page 13**
- **“Wireless Tab” on page 17**
- **“Network Tab” on page 21**
- **“Advanced Tab” on page 23**
- **“Services Tab” on page 27**
- **“System Tab” on page 31**
- **“Tools” on page 35**

## Installer Compliance Responsibility

Devices must be professionally installed and it is the professional installer’s responsibility to make sure the device is operated within local country regulatory requirements.



The *Output Power*, *Antenna Gain*, *Cable Loss*, and *TX/RX Frequency* fields are provided to the professional installer to assist in meeting regulatory requirements.

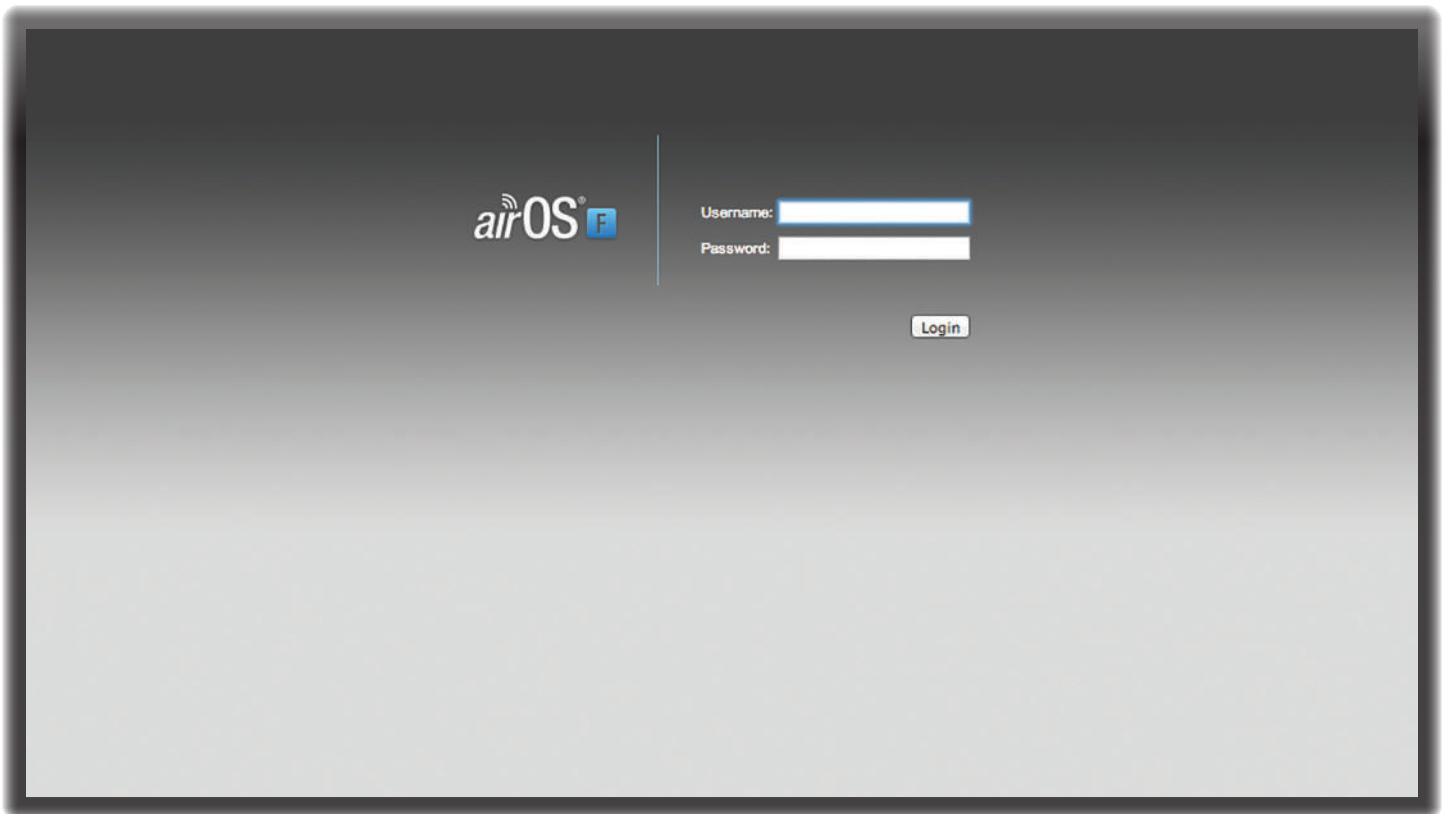

## Chapter 3: Navigation

The airFiber Configuration Interface is an advanced operating system capable of powerful wireless and routing features, built upon a simple and intuitive user interface foundation.

The airFiber X radio uses the airFiber Configuration Interface for easy configuration and management via a web browser.

There are two ways to access the airFiber Configuration Interface:

- **Management Port** Enabled by default. Use a direct connection to the *Management* port for out-of-band management.
- **In-Band Management** Enabled by default. In-band management is available through the local *Data* port or the *Data* port at the other end of the link. You can disable it on the *Network* tab. (See **“Management Network Settings”** on page 21 for more details.)

### Accessing the airFiber Configuration Interface

Connect to the airFiber Configuration Interface.

1. Make sure that your host machine is connected to the LAN that is connected to the *Management* port on the airFiber X radio.
2. Configure the Ethernet adapter on your host system with a static IP address on the 192.168.1.x subnet (for example, 192.168.1.100).

3. Launch your web browser. Type **http://192.168.1.20** in the address field and press **enter** (PC) or **return** (Mac).



4. Upon initial login, the *Terms of Use* appear on the login screen. Enter **ubnt** in the *Username* and *Password* fields, and select the appropriate choices from the *Country* and *Language* drop-down lists. Check the box next to *I agree to these terms of use*, and click **Login**.



**Note:** U.S. product versions are locked to the U.S. Country Code to ensure compliance with FCC regulations.

5. The airFiber Configuration Interface will appear, allowing you to customize your settings as needed.

## Product Verification

The airFiber Configuration Interface will verify whether a product is genuine or counterfeit.

For a genuine airFiber X radio, the airFiber Configuration Interface will display a Genuine Product logo in the lower left corner of the screen.



For any product that is not an official Ubiquiti product, the airFiber Configuration Interface will display a counterfeit warning. Please contact Ubiquiti at [support@ubnt.com](mailto:support@ubnt.com) regarding this product.



 **Note:** For product models introduced prior to 2012, the airFiber Configuration Interface will NOT display any logo in the lower left corner of the screen.

## Interface Tabs

The airFiber Configuration Interface contains six main tabs, each of which provides a web-based management page to configure a specific aspect of the airFiber X radio. This User Guide covers each tab with a chapter. For details on a specific tab, refer to the appropriate chapter.

- **Main** The **“Main Tab” on page 13** displays device status, statistics, and network monitoring links.
- **Wireless** The **“Wireless Tab” on page 17** configures basic wireless settings, including the wireless mode, link name, frequency, output power, speed, and wireless security.
- **Network** The **“Network Tab” on page 21** configures the management network settings, Internet Protocol (IP) settings, management VLAN, and automatic IP aliasing.
- **Advanced** The **“Advanced Tab” on page 23** provides more precise wireless interface controls, including advanced wireless settings and advanced Ethernet settings.
- **Services** The **“Services Tab” on page 27** configures system management services: Ping Watchdog, Simple Network Management Protocol (SNMP), servers (web, SSH, telnet), Network Time Protocol (NTP) client, Dynamic Domain Name System (DDNS) client, system log, and device discovery.
- **System** The **“System Tab” on page 31** controls system maintenance routines, administrator account management, location management, device customization, firmware update, and configuration backup. You can also change the language of the web management interface.

Each page also contains network administration and monitoring tools:

- **“Align Antenna” on page 35**
- **“Discovery” on page 36**
- **“Ping” on page 36**
- **“Traceroute” on page 36**
- **“airView” on page 36**



The screenshot shows the airFiber X web interface with the following sections:

- Navigation:** MAIN (selected), WIRELESS, NETWORK, ADVANCED, SERVICES, SYSTEM. Tools: [dropdown], Logout.
- Status:**
  - Device Name: 1250-AF5X
  - Operating Mode: Master
  - RF Link Status: Operational
  - Link Name: UBNT
  - Security: AES-128
  - Version: v3.4-beta1.29232
  - Uptime: 3 days 21:00:48
  - Link Uptime: 00:05:24
  - Remote MAC: 04:18:D6:E3:00:2E
  - Remote IP: 10.8.9.187
  - Date: 2016-06-10 16:51:16
  - TX Frequency: 5.270 GHz
  - RX Frequency: 5.280 GHz
  - Channel Width: 50 MHz
  - Frame Length: 2.0 ms
  - Radio Mode: MIMO
  - Duty Cycle: 50 %
  - Regulatory Domain: Other
  - Chain 0 (Actual/Ideal): [Progress bar] -46 / -35 dBm
  - Chain 1 (Actual/Ideal): [Progress bar] -49 / -35 dBm
  - Rem Chain 0 (Actual/Ideal): [Progress bar] -46 / -35 dBm
  - Rem Chain 1 (Actual/Ideal): [Progress bar] -46 / -35 dBm
  - Local Modulation Rate: 4x (16QAM MIMO)
  - Remote Modulation Rate: 4x (16QAM MIMO)
  - TX Capacity: 245,902,400 bps
  - RX Capacity: 245,902,400 bps
  - TX Power (EIRP): 13 dBm
  - Conducted TX Power: -7 dBm
  - Net Gain (Ant Gain/Cbl loss): 20 dBi (20 / 0 dBi)
  - Remote TX Power (EIRP): 13 dBm
  - Distance: 55 m (180 ft)
  - GPS Signal Quality: [Progress bar] 100 %
  - Latitude / Longitude: 42.134731 / -88.134018
  - Altitude: 287 m (941 ft)
  - Synchronization: Enabled
- Ethernet:**
  - MGMT MAC: 04:18:D6:51:00:35
  - MGMT: Unplugged
  - DATA: 1000Mbps-Full
  - DATA Cable Length: < 20 m
  - DATA Pair 0 (Pins 1,2): 29 dB SNR
  - DATA Pair 1 (Pins 3,6): 29 dB SNR
  - DATA Pair 2 (Pins 4,5): 29 dB SNR
  - DATA Pair 3 (Pins 7,8): 29 dB SNR
- Monitor:**
  - Performance | Log
  - Throughput: RX: 11.7kbps, TX: 70.4kbps
  - Capacity: RX: 246Mbps, TX: 246Mbps
  - Refresh button

## Chapter 4: Main Tab

The *Main* tab displays a summary of the link status information, current values of the basic configuration settings, network settings and information, and traffic statistics.

### Status

This block provides a detailed view of the Status section, including all the parameters and progress bars shown in the main screenshot.

**Device Name** Displays the customizable name or identifier of the device. The *Device Name* (or host name) is displayed in registration screens and discovery tools.

**Operating Mode** Displays the mode of the airFiber X radio: *Slave*, *Master*, or *Reset*.

**RF Link Status** Displays the status of the airFiber X radio: *RF Off*, *Syncing*, *Beaconing*, *Registering*, *Enabling*, *Listening*, *Operational*, *DFS CAC*, or *RADAR Detected*.

**Note:** Most RF Link Status values map to specific flash rates of the *Link Status* LED (See “**LEDs**” on **page 2** for more details.)

Status	Flash Rate of LED
RF Off	Off
Syncing	Short Flash (1:3 on/off cycle)
DFS countries only:	
• DFS CAC	
• RADAR Detected	
Beaconing	Normal Flash (1:1 on/off cycle)
Registering	Long Flash (3:1 on/off cycle)
Operational	On

The following applies to the AF-5X only:

When the AF-5X operates in a DFS country and within a valid DFS band for that country, it performs a Channel Availability Check (CAC) before operating. The rules vary by country and frequency, but in general:

- **FCC domains** If the AF-5X operates in a DFS band (5.2 GHz or 5.4 GHz band), the AF-5X performs a 60-second check on the *Master* only.
- **ETSI domains** For most frequencies, the AF-5X performs a 60-second check on the *Master* and *Slave*; however, if it operates in the 5600-5650 MHz range, then the AF-5X performs a 10-minute check.

While the AF-5X is performing this check, the *RF Link Status* displays *DFS CAC*, and the *RF Link Timeout* is displayed.

If radar is detected, the *RF Link Status* displays *RADAR Detected*, and the *RF Link Timeout* is displayed.

**RF Link Timeout** (Available only if the *RF Link Status* is *DFS CAC* or *RADAR Detected*.) During the *DFS CAC* or *RADAR Detected* state, the *RF Link Timeout* counts down the time remaining before the airFiber X radio can move to the next RF link state.

**Link Name** Displays the name of your link.

**Security** AES-128 is enabled at all times.

**Version** Displays the airFiber Configuration Interface software version.

**Uptime** This is the total time the device has been running since the latest reboot (when the device was powered up) or software upgrade. The time is displayed in days, hours, minutes, and seconds.

**Link Uptime** This is the total time the airFiber link has been continuously operational. The time is displayed in days, hours, minutes, and seconds.

**Remote MAC** Displays the Management Ethernet MAC address of the remote airFiber X radio.

**Remote IP** Displays the Management Ethernet IP address of the remote airFiber X radio.

**Date** Displays the current system date and time. The date and time are displayed in YEAR-MONTH-DAY HOURS:MINUTES:SECONDS format. The system date and time is retrieved from the Internet using NTP (Network Time Protocol). The NTP Client is enabled by default on the *Services* tab. The airFiber X radio doesn't have an internal clock, and the date and time may be inaccurate if the NTP Client is disabled or the device isn't connected to the Internet.

**Frequency** (Available if split frequencies are not enabled.) Displays the current frequency. The airFiber X radio uses the radio frequency specified to transmit and receive data.

**TX Frequency** (Available if split frequencies are enabled.) Displays the frequency that the airFiber X radio uses to transmit data.

**RX Frequency** (Available if split frequencies are enabled.) Displays the frequency that the airFiber X radio uses to receive data.

**Channel Width** Size of the channel in MHz.

**Frame Length** Displays the currently configured frame length of the radio: *2.0ms*, *2.5ms*, *4.0ms*, or *5ms*. Longer frame lengths result in higher throughput for a given configuration, but also result in slightly higher latency.

**Duty Cycle** Displays the duty cycle.

**Regulatory Domain** Displays the regulatory domain (*FCC/IC*, *ETSI*, or *Other*), as determined by country selection.

**Chain 0/1 (Actual/Ideal)** Displays the actual and ideal power levels (in dBm) of the received signal for each chain.

The actual number indicates the current RX signal strength. The ideal number is the RX signal strength of a perfectly aligned link. These two numbers indicate exactly how many dB out of alignment the system is.

When the link is aimed correctly, the bar graphs are full-scale. If the bar graphs are not full-scale, they indicate that your link is not optimally aimed.

**Rem Chain 0/1 (Actual/Ideal)** Displays the actual and ideal power levels (in dBm) of the received signal for each chain of the remote airFiber X radio. The bar graphs will display as full-scale once the link is aimed correctly.

**Local Modulation Rate** Displays the modulation rate:

- 8x (256QAM MIMO)
- 6x (64QAM MIMO)
- 4x (16QAM MIMO)
- 2x (QPSK MIMO)
- 1x (½ Rate QPSK xRT<sup>TM</sup>\*)
- ¼x (¼ Rate QPSK xRT)

\*xtreme Range Technology

If *Automatic Rate Adaptation* is enabled on the *Wireless* tab, then *Local Modulation Rate* displays the current speed in use and depends on the *Maximum Modulation Rate* specified on the *Wireless* tab and current link conditions.

**Remote Modulation Rate** Displays the modulation rate of the remote airFiber X radio:

- 8x (256QAM MIMO)
- 6x (64QAM MIMO)
- 4x (16QAM MIMO)
- 2x (QPSK MIMO)
- 1x (½ Rate QPSK xRT)
- ¼x (¼ Rate QPSK xRT)

**TX Capacity** Displays the potential TX throughput, how much the airFiber X radio can send, after accounting for the modulation and error rates.



**RX Capacity** Displays the potential RX throughput, how much the airFiber X radio can receive, after accounting for the modulation and error rates.

**TX Power (EIRP)** Displays the current average transmit output power (in dBm) of the airFiber X radio.



**Note:** If “(Limited)” is displayed, the transmit output power has been limited to a value less than the selected value, to comply with regulatory region requirements. For a list of maximum output power values by country and region, refer to **“Frequency Ranges and Power Levels per Country/Region” on page 53.**

**Conducted TX Power** Displays the conducted transmit power out of the radio before any antenna gain.

**Net Gain** Displays the airFiber X radio’s net antenna gain, which is the antenna gain minus cable loss. Antenna gain (the gain of the antenna being used) and cable loss (the loss in the cable from the radio to the antenna) are set using the *Antenna Gain* and *Cable Loss* fields on the *Wireless* tab.

**Remote TX Power (EIRP)** Displays the current average transmit output power (in dBm) of the remote airFiber X radio.

**Distance** Displays the distance between the airFiber X radios.

**GPS Signal Quality** Displays Global Positioning System (GPS) signal quality as a percentage value on a scale of 0-100%.

**Latitude/Longitude** Based on GPS tracking, reports the device’s current latitude and longitude. Clicking the link opens the reported latitude and longitude in a browser using Google Maps™ (<http://maps.google.com>).

**Altitude** Based on GPS tracking, reports the device’s current altitude relative to sea level.

**Synchronization** airFiber uses GPS to synchronize the timing of its transmissions. By default, this option is disabled.

## Ethernet

Ethernet	
MGMT MAC:	04:18:0B:51:00:28
MGMT:	100Mbps-Full
DATA:	No Link
DATA Cable Length:	N/A
DATA Pair 0 (Pins 1,2):	open at 1 m (3 ft)
DATA Pair 1 (Pins 3,6):	open at 1 m (3 ft)
DATA Pair 2 (Pins 4,5):	open at 1 m (3 ft)
DATA Pair 3 (Pins 7,8):	open at 6 m (20 ft)

**MGMT MAC** Displays the MAC address of the *Management* port.

**MGMT** Displays the speed and duplex of the *Management* port.

**DATA** Displays the speed and duplex of the *Data* port.

**DATA Cable Length** Displays the Ethernet cable length from radio to remote port. This is displayed only for cables longer than 20 m.

**DATA Pair 0 (Pins 1,2)** If the cable is functioning properly, displays the SNR of the twisted pair; if the cable has a fault, displays the fault (“open” or “short”) and the distance at which the fault has occurred. If the remote port is administratively shut down, this field displays “normal”.

**DATA Pair 1 (Pins 3,6)** If the cable is functioning properly, displays the SNR of the twisted pair; if the cable has a fault, displays the fault (“open” or “short”) and the distance at which the fault has occurred. If the remote port is administratively shut down, this field displays “normal”.

**DATA Pair 2 (Pins 4,5)** If the cable is functioning properly, displays the SNR of the twisted pair; if the cable has a fault, displays the fault (“open” or “short”) and the distance at which the fault has occurred. If the remote port is administratively shut down, this field displays “normal”.

**DATA Pair 3 (Pins 7,8)** If the cable is functioning properly, displays the SNR of the twisted pair; if the cable has a fault, displays the fault (“open” or “short”) and the distance at which the fault has occurred. If the remote port is administratively shut down, this field displays “normal”.

## Monitor

There are two monitoring tools accessible via the links on the *Main* tab. The default is *Performance*, which is displayed when you first open the *Main* tab.

### Performance

*Throughput* and *Capacity* charts display the current and potential data traffic.

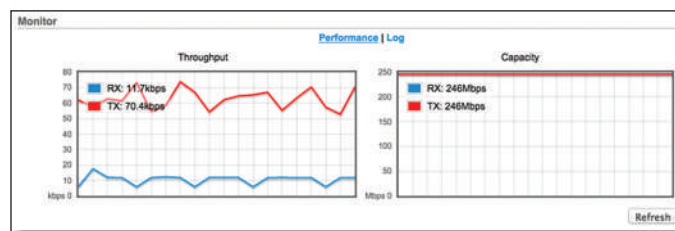

### Throughput

*Throughput* displays the current data traffic on the *Data* port in both graphical and numerical form. The chart scale and throughput dimension (Bps, Kbps, Mbps) change dynamically depending on the mean throughput value. The statistics are updated automatically.

### Capacity

*Capacity* displays the potential data traffic on the *Data* port in both graphical and numerical form. The chart scale and throughput dimension (Bps, Kbps, Mbps) change dynamically depending on the mean throughput value. The statistics are updated automatically.

**Refresh** If there is a delay in the automatic update, click **Refresh** to manually update the statistics.

## Log

When logging is enabled (see [“System Log” on page 29](#) to enable logging), this option lists all registered system events. By default, logging is not enabled.

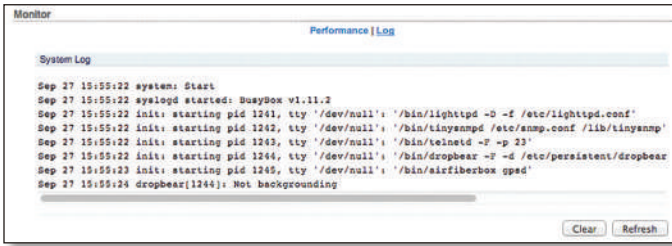

The screenshot shows a web interface window titled "Monitor" with a sub-tab "Performance | Log". Inside, there is a section labeled "System Log" containing a list of system events. At the bottom of the log area are two buttons: "Clear" and "Refresh".

```
Sep 27 15:55:22 system: Start
Sep 27 15:55:22 syslogd started: BusyBox v1.11.2
Sep 27 15:55:22 init: starting pid 1241, tty '/dev/null': '/bin/lighttpd -D -f /etc/lighttpd.conf'
Sep 27 15:55:22 init: starting pid 1242, tty '/dev/null': '/bin/tinysnmpd /etc/snmp.conf /lib/tinysnmp'
Sep 27 15:55:22 init: starting pid 1243, tty '/dev/null': '/bin/telnetd -F -p 23'
Sep 27 15:55:22 init: starting pid 1244, tty '/dev/null': '/bin/dropbear -F -d /etc/persistent/dropbear'
Sep 27 15:55:23 init: starting pid 1245, tty '/dev/null': '/bin/airfiberbox gped'
Sep 27 15:55:24 dropbear(1244): Not backgrounding
```

**Clear** To delete all entries in the system log, click **Clear**.

**Refresh** To update the log content, click **Refresh**.

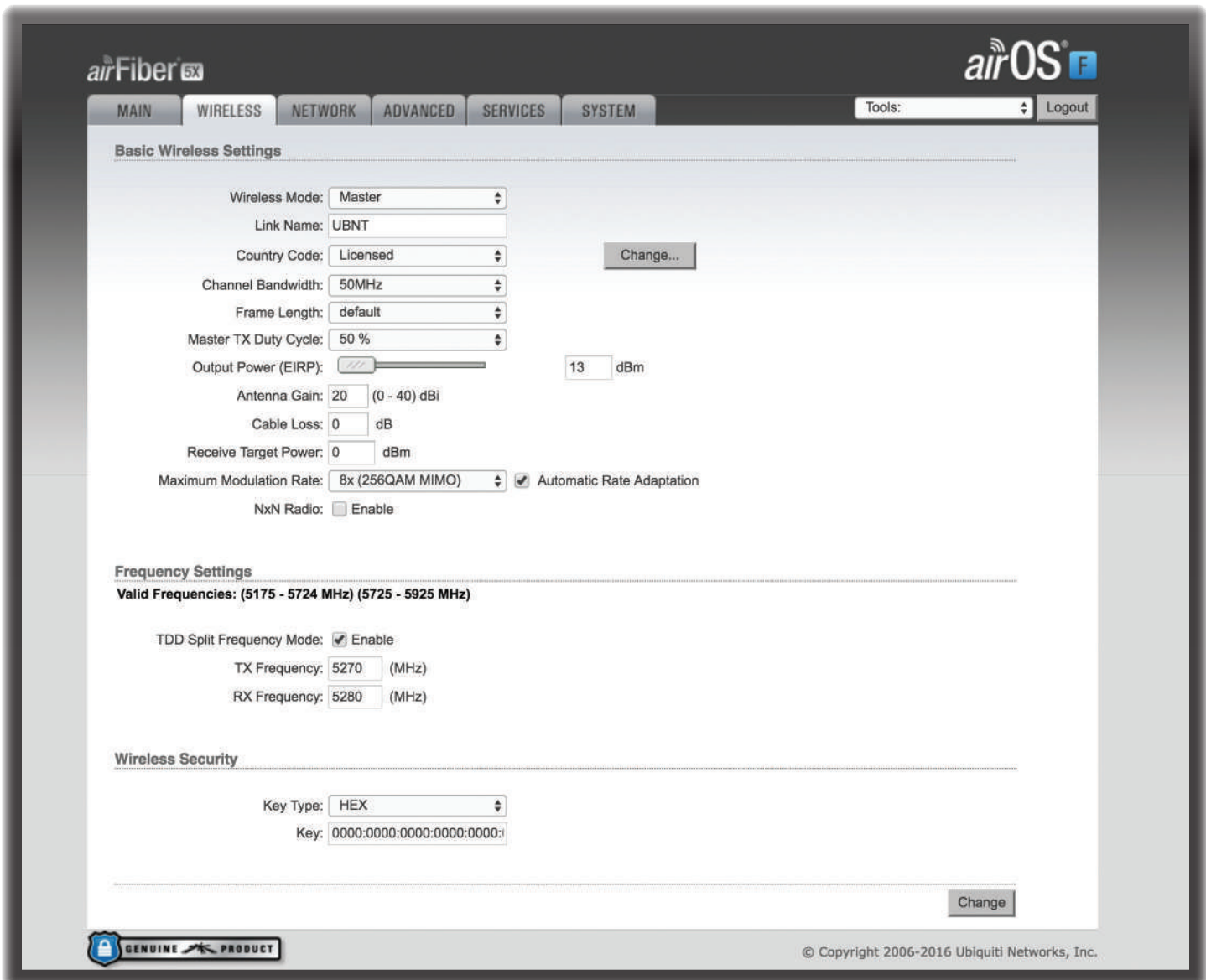

## Chapter 5: Wireless Tab

The *Wireless* tab contains options to set up the wireless part of the link. This includes wireless mode, link name, frequencies, output power, speed, and wireless security.

**Change** To save or test your changes, click **Change**.

A new message appears. You have three options:

- **Apply** To immediately save your changes, click **Apply**.
- **Test** To try the changes without saving them, click **Test**. To keep the changes, click **Apply**. If you do not click *Apply* within 180 seconds (the countdown is displayed), the airFiber X radio times out and resumes its earlier configuration.
- **Discard** To cancel your changes, click **Discard**.

Write down the settings you configure on the *Wireless* tab. You will need to enter the same settings on the airFiber X radio at the other end of your PtP link. The exceptions are as follows:

- **Wireless Mode** Configure one airFiber X radio as the *Master* and the other as the *Slave*.

### Basic Wireless Settings

In this section, configure the basic wireless settings, such as wireless mode, link name, country code, frequencies, output power, speed, and gain.

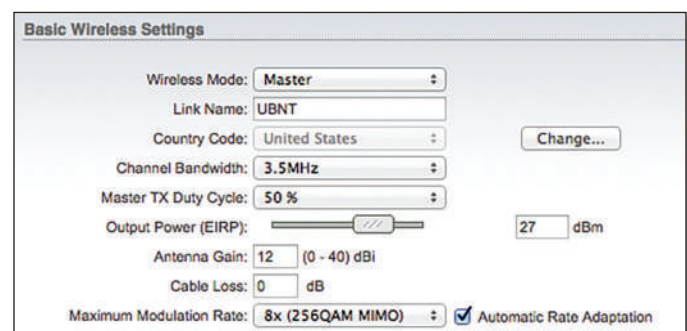

**Wireless Mode** By default, the Wireless Mode is *Slave*. You must configure one airFiber X radio as **Master** because each PtP link must have one *Master*.

**Link Name** Enter a name for your PtP link. This name must be the same on both Master and Slave radios in order for them to connect.

**Country Code** Each country has its own power level and frequency regulations. *To ensure the airFiber X radio operates under the necessary regulatory compliance rules, you must select the country where your device will be used.* The frequency settings and output power limits will be tuned according to the regulations of the selected country. For details, refer to this table, **“Frequency Ranges and Power Levels per Country/Region” on page 53.**

*This radio is restricted to use with a license and to use only in certain EU countries or geographical areas of EU countries.*

- **Change** To select a new country, click **Change**.

 **Note:** U.S. product versions are locked to the U.S. Country Code to ensure compliance with FCC regulations.

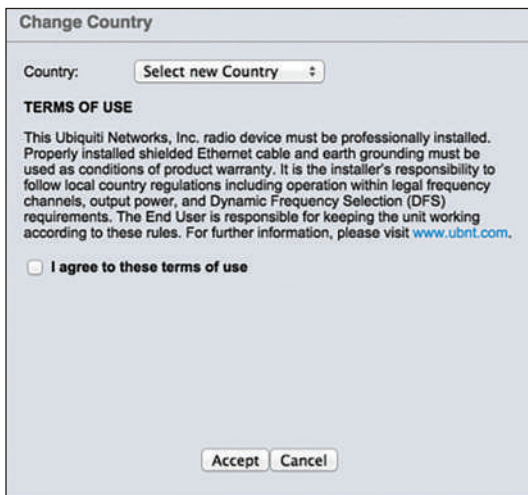

- **Country** Select the new country.
- **I agree to these terms of use** Check this box; you must agree to the *Terms of Use* to use the product.
- **Accept** Saves your change.
- **Cancel** Discards your change.

**Channel Bandwidth** Select the appropriate channel size:

- AF-2X, AF-3X, and AF-4X: **3.5, 5, 7, 10, 14, 20, 28, 30, 40, 50, or 56 MHz**
- AF-5X only: **5, 10, 20, 30, 40, or 50 MHz**

 **Note:** The available channel bandwidths depend on the regulatory requirements of the currently selected country or region.

**Frame Length** (Available on AF-2X, AF-3X, and AF-4X only.) Use this to specify the frame length of the radio: **default, 2.0ms, 2.5ms, 4.0ms, or 5ms.** The frame length must be the same on both Master and Slave radios. The *default* value corresponds to *5ms* for the 3.5 MHz and 5 MHz bandwidths, or *2.0ms* for all other bandwidths.

 **Note:** The AF-5X uses a frame length of 2.0ms (this value cannot be changed).

**Master TX Duty Cycle** Use this to change the duty cycle of the RF link (the Master’s TX percentage). Choose one of the following values: **25%, 33%, 50%, 67%, or 75%.**

**Output Power (EIRP)** Defines the maximum average transmit output power (in dBm) of the airFiber X radio. To specify the output power, use the slider or manually enter the output power value. The transmit power level maximum is limited according to country regulations.

 **Note:** The *Antenna Gain* and *Cable Loss* should be configured before the *Output Power*. This is because the range of the *Output Power* field is affected by the *Antenna Gain* and *Cable Loss* values – changing the antenna gain or cable loss adjusts the maximum and minimum values you can select using the *Output Power* slider. Since the *Output Power* already includes the antenna gain and cable loss, it represents EIRP; therefore, the value of *Output Power* is actually the total power the radio is transmitting over the air. The current transmit power is displayed by the TX Power EIRP setting on the *Main* tab.

 **Note:** The airFiber X radio may limit the output power to a value less than the value specified by this field, to comply with regulatory region requirements. For a list of maximum output power values by country and region, refer to **“Frequency Ranges and Power Levels per Country/Region” on page 53.**

**Antenna Gain** Enter the gain in dBi of the antenna that is used in your installation. An improper value could cause DFS false detections when operating on DFS frequencies.

**Cable Loss** Enter the cable loss in dB of the cable that is used in your installation. An improper value could cause DFS false detections when operating on DFS frequencies.

 **Note:** If you are using the airFiber AF-5X radio with an airFiber NxN Multiplexer, set the *Cable Loss* to a value that includes the *additional* cable loss due to the Multiplexer. The additional cable loss (in dB) is:

- **4.1** for the AF-MPx4, or
- **7.2** for the AF-MPx8

**Receive Target Power** Enter the desired power level that the receiver (on the far end of the link) should see from this radio. This value is used by the Automatic Transmit Power Control (ATPC) feature.



In ATPC, each airFiber radio monitors the amount of power received by the radio at the other end of the link. If the reported value differs from the *Receive Target Power* value, the radio automatically adjusts its transmit output power to match the *Receive Target Power* value. The radio will use its *Output Power (EIRP)* setting as the maximum level at which it will transmit to maintain the *Receive Target Power*.

**Maximum Modulation Rate or Modulation Rate** Higher modulations support greater throughput but generally require stronger RF signals and a higher Signal-to-Noise Ratio (SNR). By default, *Automatic Rate Adaptation* is enabled, and *Maximum Modulation Rate* is displayed. This allows the airFiber X radio to automatically adjust the modulation rate to changing RF signal conditions. Under certain conditions, you may prefer to lock the *Maximum Modulation Rate* to a lower setting to improve link performance.

When *Automatic Rate Adaptation* is disabled, *Modulation Rate* is displayed. Lock the *Modulation Rate* to the setting of your choice.

Select one of the available modulation rates:

- **8x (256QAM MIMO)**
- **6x (64QAM MIMO)**
- **4x (16QAM MIMO)**
- **2x (QPSK MIMO)**
- **1x (½ Rate QPSK xRT)**
- **¼x (¼ Rate QPSK xRT)**

**NxN Radio** (Available for AF-5X only.) Select this option if you are using the airFiber AF-5X radio with an airFiber Multiplexer. For additional details, refer to [“airFiber Configuration” on page 4](#).

## Frequency Settings

The *Valid Frequencies* for your *Country Code* selection are displayed. Ensure that you use frequencies that comply with the local country regulations.

**TDD Split Frequency Mode** This option lets you configure separate frequencies for TX and RX. To configure split frequencies, enable this option and select a different RX frequency on each side of the link. This feature is useful if both sides of the link do not have a common, clean frequency. It is important for the RX frequency to be clean; if different frequencies are clean on each end of the link, select the clean RX frequency on each end.

Frequency Settings	
Valid Frequencies: (2410 - 2474 MHz)	
TDD Split Frequency Mode:	<input checked="" type="checkbox"/> Enable
TX Frequency:	2440 (MHz)
RX Frequency:	2440 (MHz)

AF-2X Split Frequency Settings

Frequency Settings	
Valid Frequencies: (3655 - 3695 MHz)	
TDD Split Frequency Mode:	<input checked="" type="checkbox"/> Enable
TX Frequency:	3670 (MHz)
RX Frequency:	3670 (MHz)

AF-3X Split Frequency Settings

Frequency Settings	
Valid Frequencies: (4600 - 5100 MHz)	
TDD Split Frequency Mode:	<input checked="" type="checkbox"/> Enable
TX Frequency:	4965 (MHz)
RX Frequency:	5000 (MHz)

AF-4X Split Frequency Settings

Frequency Settings	
Valid Frequencies: (5175 - 5230 MHz) (5740 - 5830 MHz)	
TDD Split Frequency Mode:	<input checked="" type="checkbox"/> Enable
TX Frequency:	5775 (MHz)
RX Frequency:	5200 (MHz)

AF-5X Split Frequency Settings



**Note for AF-5X only:** Split frequency mode is not available in DFS bands because the RX and TX frequencies must match to allow the receiver to scan for DFS on the TX frequency. In regions where both DFS and non-DFS frequencies are available, enabling split frequencies will disable any DFS band frequencies. In regions where only DFS frequencies are available, there will be no option to turn on split frequency mode.

**Frequency** (Available if split frequencies are disabled.) Enter a valid frequency. The current state is displayed.



**Note:** The Master and Slave should have the same *Frequency* setting.

**TX Frequency** (Available if split frequencies are enabled.) Enter a valid TX frequency. The current state is displayed.

**RX Frequency** (Available if split frequencies are enabled.) Enter a valid RX frequency. The current state is displayed.

## Wireless Security

airFiber uses 128-bit, AES (Advanced Encryption Standard) encryption at all times.

Wireless Security	
Key Type:	HEX
Key:	0000:0000:0000:0000:0000

**Key Type** Specifies the character format.

- **HEX** By default, this option uses hexadecimal characters. 0-9, A-F, or a-f are valid characters.
- **ASCII** ASCII uses the standard English alphabet and numeric characters (0-9, A-Z, or a-z).

**Key** Select the format of the MAC address.

- **HEX** Enter 16 bytes (eight, 16-bit hexadecimal values). You can omit zeroes and use colons, similar to the IPv6 format. The default is:

**0000:0000:0000:0000:0000:0000:0000:0000**



**Note:** The airFiber Configuration Interface supports IPv6 formats excluding dotted quad and "::" (double-colon) notation.

- **ASCII** Enter a combination of alphanumeric characters. Using 128-bit SHA1 (Secure Hash Algorithm 1), the airFiber X radio hashes the ASCII key to create a 128-bit key for AES.

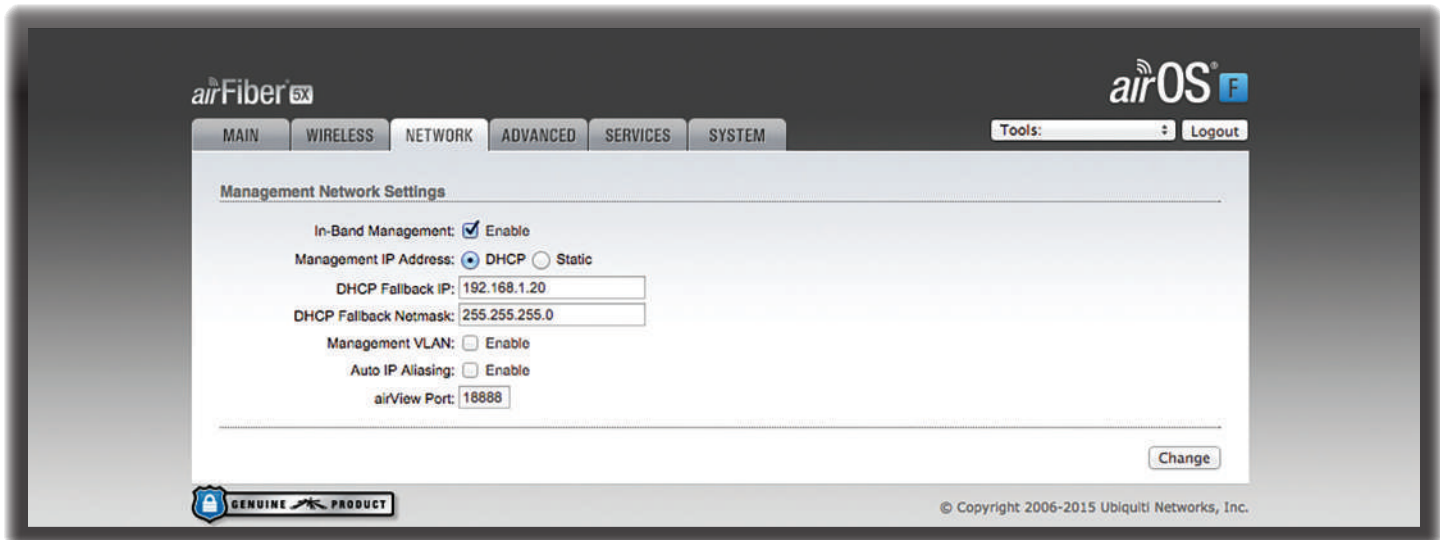

## Chapter 6: Network Tab

The *Network* tab allows you to configure settings for the management network. There are two ways to access the airFiber Configuration Interface:

- **Management Port** Enabled by default. Use a direct connection to the *Management* port for out-of-band management.
- **In-Band Management** Enabled by default. In-band management is available through the local *Data* port or the *Data* port at the other end of the link.

The *Management* port and in-band management share the default IP address of *192.168.1.20*.

**Change** To save or test your changes, click **Change**.

A new message appears. You have three options:

- **Apply** To immediately save your changes, click **Apply**.
- **Test** To try the changes without saving them, click **Test**. To keep the changes, click **Apply**. If you do not click *Apply* within 180 seconds (the countdown is displayed), the airFiber X radio times out and resumes its earlier configuration.
- **Discard** To cancel your changes, click **Discard**.

### Management Network Settings

**In-Band Management** Enabled by default. In-band management is available through the local *Data* port or the *Data* port at the other end of the link.

**Note:** If *In-Band Management* is enabled, ensure that each airFiber X radio in a link has a unique *IP Address*. If the airFiber X radios use the same *IP Address*, you may lose access via the *Data* ports.

**Management IP Address** The airFiber X radio can use a static IP address or obtain an IP address from its DHCP server.

- **DHCP** Keep the default, *DHCP*, to use DHCP reservation on your router to assign a unique *IP Address*. The local DHCP server assigns a reserved IP address, gateway IP address, and DNS address to the airFiber X radio.

**Note:** If you select the *DHCP* option, ensure that you use DHCP reservation because if you do not know the IP address, then the only way to manage the airFiber X radio is to reset the airFiber X radio to its factory default settings. (Press and hold the **Reset** button for more than five seconds.) Its default *Management IP Address* is reset to *192.168.1.20*.

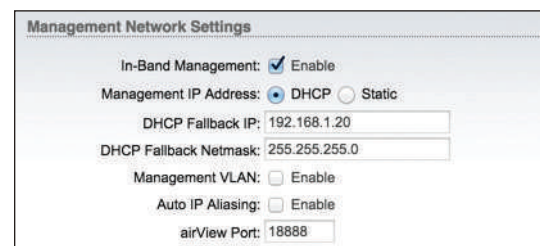

- **DHCP Fallback IP** Specify the IP address the airFiber X radio should use if a DHCP server is not found.
- **DHCP Fallback Netmask** Specify the netmask the airFiber X radio should use if a DHCP server is not found.
- **Static** Assign static IP settings to the airFiber X radio.

**Note:** IP settings should be consistent with the address space of the airFiber X radio's network segment.

The screenshot shows the 'Management Network Settings' configuration page. The settings are as follows:

- In-Band Management:**  Enable
- Management IP Address:**  DHCP  Static
- IP Address:** 0.0.0.0
- Netmask:** 255.255.255.0
- Gateway IP:** 192.168.1.1
- Primary DNS IP:** [Empty field]
- Secondary DNS IP:** [Empty field]
- Management VLAN:**  Enable
- Auto IP Aliasing:**  Enable
- airView Port:** 18888

**airView Port** The port number associated with the airView spectrum analyzer tool. The default value is 18888. For detailed information on the airView tool, refer to [“airView” on page 36](#).

- **IP Address** Specify the IP address of the airFiber X radio. This IP will be used for device management purposes.
- **Netmask** When the netmask is expanded into its binary form, it provides a mapping to define which portions of the IP address range are used for the network devices and which portions are used for host devices. The netmask defines the address space of the airFiber X radio's network segment. The 255.255.255.0 (or "/24") netmask is commonly used on many Class C IP networks.
- **Gateway IP** Typically, this is the IP address of the host router, which provides the point of connection to the Internet. This can be a DSL modem, cable modem, or WISP gateway router. The airFiber X radio directs data packets to the gateway if the destination host is not within the local network.
- **Primary DNS IP** Specify the IP address of the primary DNS (Domain Name System) server.
- **Secondary DNS IP** Specify the IP address of the secondary DNS server. This entry is optional and used only if the primary DNS server is not responding.

**Management VLAN** If enabled, automatically creates a management Virtual Local Area Network (VLAN).

- **VLAN ID** Enter a unique VLAN ID from 2 to 4094.

**Auto IP Aliasing** If enabled, automatically generates an IP address for the corresponding WLAN/LAN interface. The generated IP address is a unique Class B IP address from the 169.254.X.Y range (netmask 255.255.0.0), which is intended for use within the same network segment only. The Auto IP always starts with 169.254.X.Y, with X and Y as the last two octets from the MAC address of the airFiber X radio. For example, if the MAC address is 00:15:6D:A3:04:FB, then the generated unique Auto IP will be 169.254.4.251. (The hexadecimal value, *FB*, converts to the decimal value, *251*.)

The Auto IP Aliasing setting can be useful because you can still access and manage devices even if you lose, misconfigure, or forget their IP addresses. Because an Auto IP address is based on the last two octets of the MAC address, you can determine the IP address of a device if you know its MAC address.



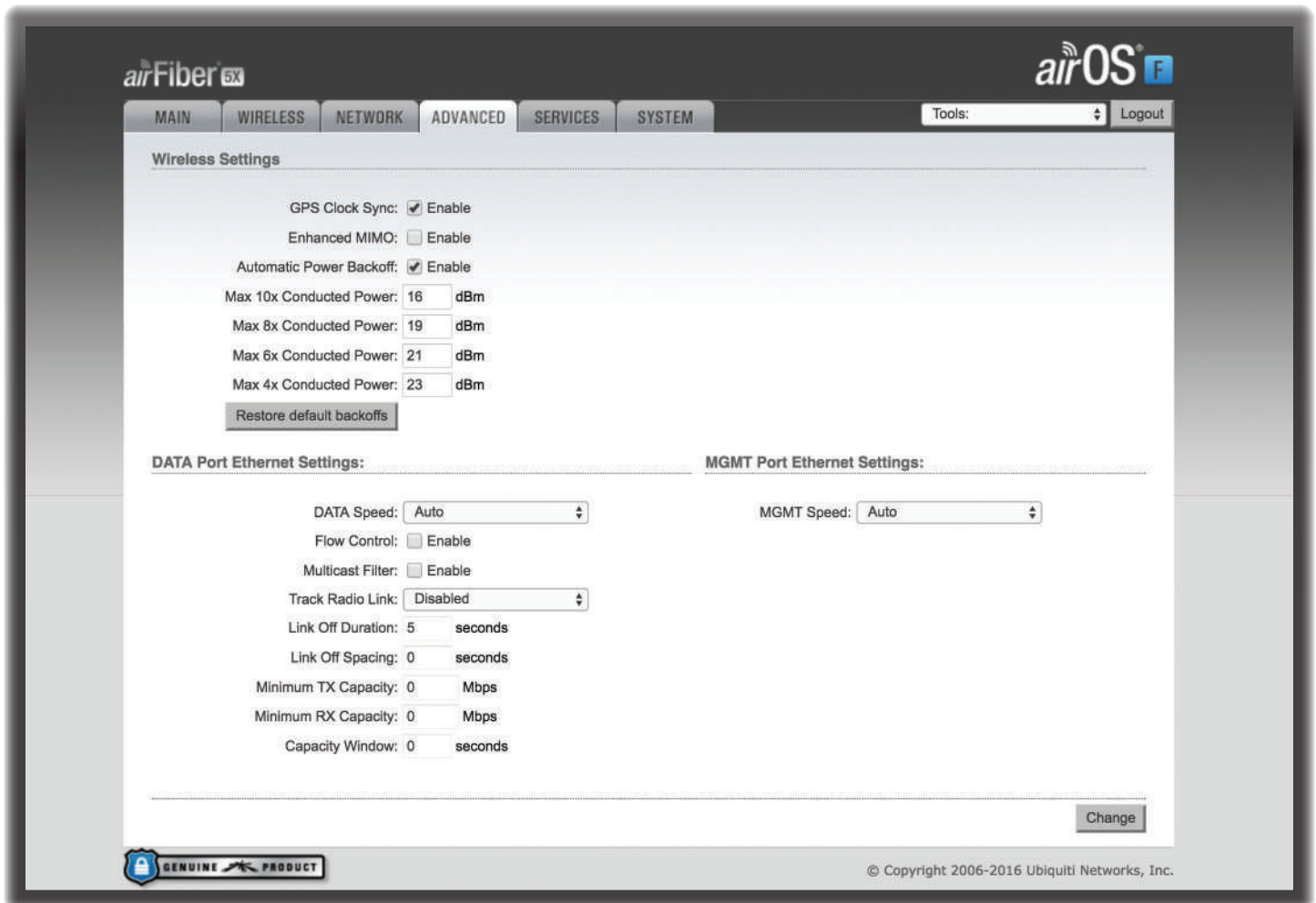

## Chapter 7: Advanced Tab

The *Advanced* tab handles advanced wireless and Ethernet settings. These settings should not be changed unless you understand how the changes will affect the airFiber X radio.

**Change** To save or test your changes, click **Change**.

A new message appears. You have three options:

- **Apply** To immediately save your changes, click **Apply**.
- **Test** To try the changes without saving them, click **Test**. To keep the changes, click **Apply**. If you do not click *Apply* within 180 seconds (the countdown is displayed), the airFiber X radio times out and resumes its earlier configuration.
- **Discard** To cancel your changes, click **Discard**.

## Wireless Settings

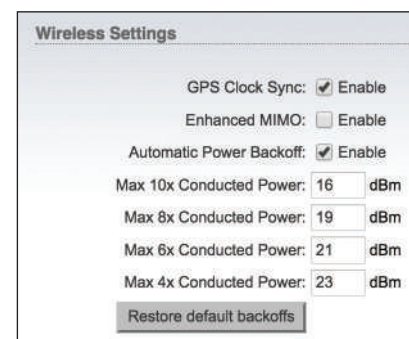

**GPS Clock Sync** The airFiber uses GPS to synchronize the timing of its transmissions. By default, this option is disabled.

**Enhanced MIMO** Select this option to enable the Enhanced MIMO feature. Enhanced MIMO increases sensitivity which may result in greater TX throughput in low-noise environments. If enabling this feature does not result in improved throughput, the noise level is too high and you should disable this feature. This feature is disabled by default.

**Automatic Power Backoff** This feature allows the radio to automatically adjust the maximum TX power per modulation so that the radio never transmits at a higher power than each modulation rate can decode. The default values in the *Max 10x/8x/6x/4x Conducted Power* fields are values determined to work at all temperatures and all frequencies supported by the radio.

It may, however, be possible to increase the maximum TX power for one or more modulations based on your radio's operating environment. For example, if a radio is running at 6x and trying to switch into 8x operation, you can increase the *Max 8x Conducted Power* value 1 dB at a time to see if the radio can maintain 8x operation (*Automatic Power Backoff* must be enabled to allow the *Max Conducted Power* fields to be edited). The same can be done with 6x and 4x up to the maximum conducted power of the radio.

**Max 10x/8x/6x/4x Conducted Power** The maximum conducted power for the 10x/8x/6x/4x modulation rates. Each field is editable only if *Automatic Power Backoff* is enabled.

**Restore Default Backoffs** Click this button to restore the default *Max Conducted Power* values.

## DATA Port Ethernet Settings

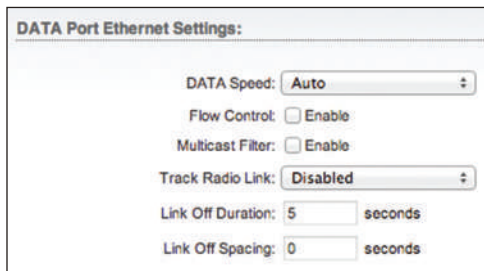

**DATA Speed** This is the speed of the *Data* port. The default is **Auto**. The airFiber X radio automatically negotiates transmission parameters, such as speed and duplex, with its counterpart. In this process, the networked devices first share their capabilities and then choose the fastest transmission mode they both support.

To manually specify the maximum transmission link speed and duplex mode, select one of the following options: **100 Mbps-Full**, **100 Mbps-Half**, **10 Mbps-Full**, or **10 Mbps-Half**.

To disable the Ethernet data port, select **Disabled**.

**Note:** If *Disabled* is selected, ensure that the radio is accessible using the *Management* Ethernet port or over the RF link (with in-band management enabled), or all communication with the radio will be lost.

Full-duplex mode allows communication in both directions simultaneously. Half-duplex mode allows communication in one direction at a time, alternating between transmission and reception.

**Flow Control** If enabled, the airFiber X radio generates and responds to Ethernet layer PAUSE frames. The airFiber X radio regulates inbound traffic from the customer's network to avoid buffer overflows within the airFiber X radio. Flow control has the effect of controlling the inter-packet spacing of packets headed into the airFiber Data interface.

**Multicast Filter** If enabled, the filter blocks multicast traffic from overloading the CPU when in-band management is enabled. This allows the airFiber X radio to be managed in-band when the customer's network is carrying large volumes of multicast traffic, such as IPTV. The filter does not block multicast traffic going over the radio; it simply blocks it from reaching the airFiber's management interface CPU.

**Track Radio Link** If this option is enabled, the airFiber X radio disconnects the Data port's Ethernet link when the RF link is lost (The Management port is never disabled by this option). The *Track Radio Link* option is useful because it quickly indicates a "link lost" condition to the customer's routing equipment (such as a direct connection to OSPF-enabled routers).

- **Disabled** The *Track Radio Link* option is disabled by default. The Data port's Ethernet link will always remain up regardless of the RF link state.
- **Use Timeout Duration** This option is designed for use by operators who are using in-band management. Two timers control the Data port's Ethernet link.

RF Link	Ethernet Link	Notes
Goes down for the first time	The Ethernet link goes down and remains down for the number of seconds specified by the <i>Link Off Duration</i> timer.  The Ethernet link will then come back up so that the airFiber X radio can be managed even when the RF link is down.	Even if the RF link goes back up before the <i>Link Off Duration</i> timer elapses, the Ethernet link remains down.  The Ethernet link's downtime is long enough to signal to the customer's routing equipment that the path is lost.
Goes down for the second time	The Ethernet link remains up as long as time remains on the <i>Link Off Spacing</i> timer.  When the <i>Link Off Spacing</i> timer elapses, then the Ethernet link goes down again for the number of seconds specified by the <i>Link Off Duration</i> timer. (This happens only if the RF link is still down.)	The Ethernet link's uptime is long enough so the operator has enough time to access the airFiber X radio, make configuration changes, and save those changes.  Sufficient Ethernet link uptime is vital when a RF link is constantly up and down.

If the *Use Timeout Duration* option is enabled, the *Track Radio Link* option and the following timers are enabled:

- **Link Off Duration** The *Link Off Duration* timer controls the length of time the Data port's Ethernet link will be down if the RF link goes down. Enter the number of seconds that the Ethernet link should be offline. For example, if this is set to 10 seconds, then when the RF link goes down, the Ethernet link will go down and remain down for 10 seconds (regardless of the RF link state), and then it will go back up.
- **Link Off Spacing** The *Link Off Spacing* timer controls the length of time the airFiber X radio will wait before allowing the Data port's Ethernet link to go down for a second time if the RF link goes down again. Enter the minimum interval (in seconds) between offline events of the Ethernet link, regardless of the RF link status. The value for *Link Off Spacing* should be larger than the value for *Link Off Duration*, and it should be enough time for the operator to access the airFiber X radio, make any configuration changes, and apply those changes.



**Note:** If the *Link Off Spacing* timer is set to 0 seconds, then the Ethernet link will only use the *Link Off Duration* timer. If the *Link Off Duration* timer is set to 10 seconds and the RF link goes down, then the Ethernet link will go down for 10 seconds and then go back up regardless of the RF link state. If the RF link is still down, then the Ethernet link will not go down again until the RF link goes back up and then down again.

Here are a couple of examples involving the use of the *Use Timeout Duration* option.

• Example #1

- **Link Off Duration** 5 seconds
- **Link Off Spacing** 60 seconds

The Data port's Ethernet link will be initially disconnected when the RF link first goes down. That event will start a 60-second timer. The Ethernet link will remain offline for 5 seconds (regardless of the RF link status) and then come back online. The Ethernet link will remain online (regardless of the RF link state) until the 60-second timer expires.

• Example #2

- **Link Off Duration** 20 seconds
- **Link Off Spacing** 120 seconds

The Data port's Ethernet link will be initially disconnected when the RF link first goes down. That event will start a 120-second timer. The RF link goes back up after 10 seconds; however, that does not affect the Ethernet link. The Ethernet link will remain offline for 20 seconds and then come back online. The RF link goes down again after 60 seconds; however, that does not affect the Ethernet link. The Ethernet link will then remain online until the 120-second timer expires.

- **Enabled** This option is designed for use by operators who are not using in-band management. The *Track Radio Link* option is enabled without timers, so the Data port's Ethernet link follows the RF link state exactly. If the RF link goes down, then the Ethernet link goes down and remains down until the RF link goes back up.

**Minimum TX Capacity** This is the minimum allowable TX capacity before the link is dropped. If the capacity drops below this threshold, the Ethernet link will be dropped. If set to 0, then capacity will not be used; only the RF link state will be used.

**Minimum RX Capacity** This is the minimum allowable RX capacity before the link is dropped. If the capacity drops below this threshold, the Ethernet link will be dropped. If set to 0, then capacity will not be used; only the RF link state will be used.

**Capacity Window** This is the number of continuous seconds that the radio must remain under the minimum TX or RX capacity before the link is dropped. If set to 0, then as soon as capacity drops below a set limit, the Ethernet link will be dropped.

## MGMT Port Ethernet Settings

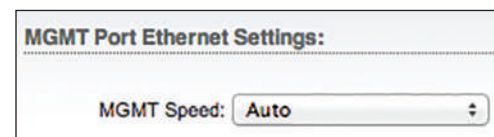

**MGMT Speed** This is the speed of the *Management* port. By default, the option is **Auto**. The airFiber X radio automatically negotiates transmission parameters, such as speed and duplex, with its counterpart. In this process, the networked devices first share their capabilities and then choose the fastest transmission mode they both support.

To manually specify the maximum transmission link speed and duplex mode, select one of the following options: **100 Mbps-Full**, **100 Mbps-Half**, **10 Mbps-Full**, or **10 Mbps-Half**. If you are running extra long Ethernet cables, a link speed of 10 Mbps could help to achieve better stability.

Full-duplex mode allows communication in both directions simultaneously. Half-duplex mode allows communication in one direction at a time, alternating between transmission and reception.





## Chapter 8: Services Tab

The *Services* tab configures system management services: *Ping Watchdog*, *SNMP Agent*, *Web Server*, *SSH Server*, *Telnet Server*, *NTP Client*, *Dynamic DNS*, *System Log*, and *Device Discovery*.

**Change** To save or test your changes, click **Change**.

A new message appears. You have three options:

- **Apply** To immediately save your changes, click **Apply**.
- **Test** To try the changes without saving them, click **Test**. To keep the changes, click **Apply**. If you do not click *Apply* within 180 seconds (the countdown is displayed), the airFiber X radio times out and resumes its earlier configuration.
- **Discard** To cancel your changes, click **Discard**.

### Ping Watchdog

*Ping Watchdog* sets the airFiber X radio to continuously ping a user-defined IP address (it can be the Internet gateway, for example). If it is unable to ping under

the user-defined constraints, the airFiber X radio will automatically reboot. This option creates a kind of “fail-proof” mechanism.

*Ping Watchdog* is dedicated to continuous monitoring of the specific connection to the remote host using the *Ping* tool. The *Ping* tool works by sending ICMP echo request packets to the target host and listening for ICMP echo response replies. If the defined number of replies is not received, the tool reboots the airFiber X radio.

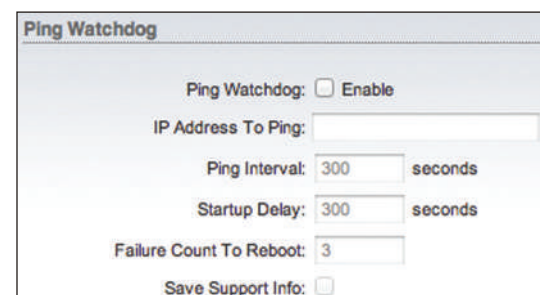

**Ping Watchdog** Enables use of *Ping Watchdog*.

- **IP Address To Ping** Specify the IP address of the target host to be monitored by *Ping Watchdog*.



- **Ping Interval** Specify the time interval (in seconds) between the ICMP echo requests that are sent by *Ping Watchdog*. The default value is 300 seconds.
- **Startup Delay** Specify the initial time delay (in seconds) until the first ICMP echo requests are sent by *Ping Watchdog*. The default value is 300 seconds.  
The Startup Delay value should be at least 60 seconds as the network interface and wireless connection initialization takes a considerable amount of time if the airFiber X radio is rebooted.
- **Failure Count to Reboot** Specify the number of ICMP echo response replies. If the specified number of ICMP echo response packets is not received continuously, *Ping Watchdog* will reboot the airFiber X radio. The default value is 3.
- **Save Support Info** This generates a support information file.

## SNMP Agent

Simple Network Monitor Protocol (SNMP) is an application layer protocol that facilitates the exchange of management information between network devices. Network administrators use SNMP to monitor network-attached devices for issues that warrant attention.

The airFiber X radio contains an *SNMP Agent*, which does the following:

- Provides an interface for device monitoring using SNMP
- Communicates with SNMP management applications for network provisioning
- Allows network administrators to monitor network performance and troubleshoot network problems

For the purpose of equipment identification, configure the *SNMP Agent* with contact and location information:

**SNMP Agent** Enables the *SNMP Agent*.

- **SNMP Community** Specify the SNMP community string. It is required to authenticate access to Management Information Base (MIB) objects and functions as an embedded password. The airFiber X radio also supports a read-only community string; authorized management stations have read access to all the objects in the MIB except the community strings, but do not have write access. The airFiber X radio supports SNMP v1. The default SNMP Community is *public*.
- **Contact** Specify the contact who should be notified in case of emergency.
- **Location** Specify the airFiber X radio's physical location.

## Web Server

The following *Web Server* parameters can be set:

**Secure Connection (HTTPS)** If enabled, the *Web Server* uses secure HTTPS mode.

- **Secure Server Port** If secure HTTPS mode is used, specify the TCP/IP port of the *Web Server*.

**Server Port** If HTTP mode is used, specify the TCP/IP port of the *Web Server*.

**Session Timeout** Specifies the maximum timeout before the session expires. Once a session expires, you must log in again using the username and password.

## SSH Server

The following *SSH Server* parameters can be set:

**SSH Server** This option enables SSH access to the airFiber X radio.

- **Server Port** Specify the TCP/IP port of the *SSH Server*.
- **Password Authentication** If enabled, you must authenticate using administrator credentials to grant SSH access to the airFiber X radio; otherwise, an authorized key is required.
- **Authorized Keys** Click **Edit** to import a public key file for SSH access to the airFiber X radio instead of using an admin password.

- **Choose File** Click **Choose File** to locate the new key file. Select the file and click **Open**.
- **Import** Imports the file for SSH access.
- **Enabled** Enables the specific key. All added keys are saved in the system configuration file; however, only the enabled keys are active on the airFiber X radio.
- **Type** Displays the type of key.

- **Key** Displays the key.
- **Comment** You can enter a brief description of the key.
- **Action** You have the following options:
  - **Add** Adds a public key file.
  - **Edit** Make changes to a public key file. Click **Save** to save your changes.
  - **Del** Deletes a public key file.
- **Save** Saves your changes.
- **Close** Discards your changes.

## Telnet Server

The following *Telnet Server* parameters can be set:

**Telnet Server** This option activates Telnet access to the airFiber X radio.

- **Server Port** Specify the TCP/IP port of the *Telnet Server*.

## NTP Client

Network Time Protocol (NTP) is a protocol for synchronizing the clocks of computer systems over packet-switched, variable-latency data networks. You can use it to set the system time on the airFiber X radio. If the *Log* option is enabled, then the system time is reported next to every log entry that registers a system event.

**NTP Client** Enables the airFiber X radio to obtain the system time from a time server on the Internet.

- **NTP Server** Specify the IP address or domain name of the NTP server.

## Dynamic DNS

Domain Name System (DNS) translates domain names to IP addresses; Each DNS server on the Internet holds these mappings in its respective DNS database. Dynamic Domain Name System (DDNS) is a network service that notifies the DNS server in real time of any changes in the airFiber X radio's IP settings. Even if the airFiber X radio's IP address changes, you can still access the airFiber X radio through its domain name.

**Dynamic DNS** If enabled, the airFiber X radio allows communications with the DDNS server.

- **Host Name** Enter the host name of the DDNS server.
- **Username** Enter the user name of the DDNS account.
- **Password** Enter the password of the DDNS account.
- **Show** Check the box to display the password characters.

## System Log

**System Log** This option enables the registration routine of system log (syslog) messages. By default it is disabled.

- **Remote Log** Enables the syslog remote sending function. System log messages are sent to a remote server, which is specified in the *Remote Log IP Address* and *Remote Log Port* fields.
  - **Remote Log IP Address** The host IP address that receives syslog messages. Properly configure the remote host to receive syslog protocol messages.
  - **Remote Log Port** The TCP/IP port that receives syslog messages. *514* is the default port for the commonly used system message logging utilities.

Every logged message contains at least a system time and host name. Usually a specific service name that generates the system event is also specified within the message. Messages from different services have different contexts and different levels of detail. Usually error, warning, or informational system service messages are reported; however, more detailed debug level messages can also be reported. The more detailed the system messages reported, the greater the volume of log messages generated.

## Device Discovery

**Discovery** Enables device discovery, so the airFiber X radio can be discovered by other Ubiquiti devices through the *Discovery* tool.

**CDP** Enables Cisco Discovery Protocol (CDP) communications, so the airFiber X radio can send out CDP packets to share its information.





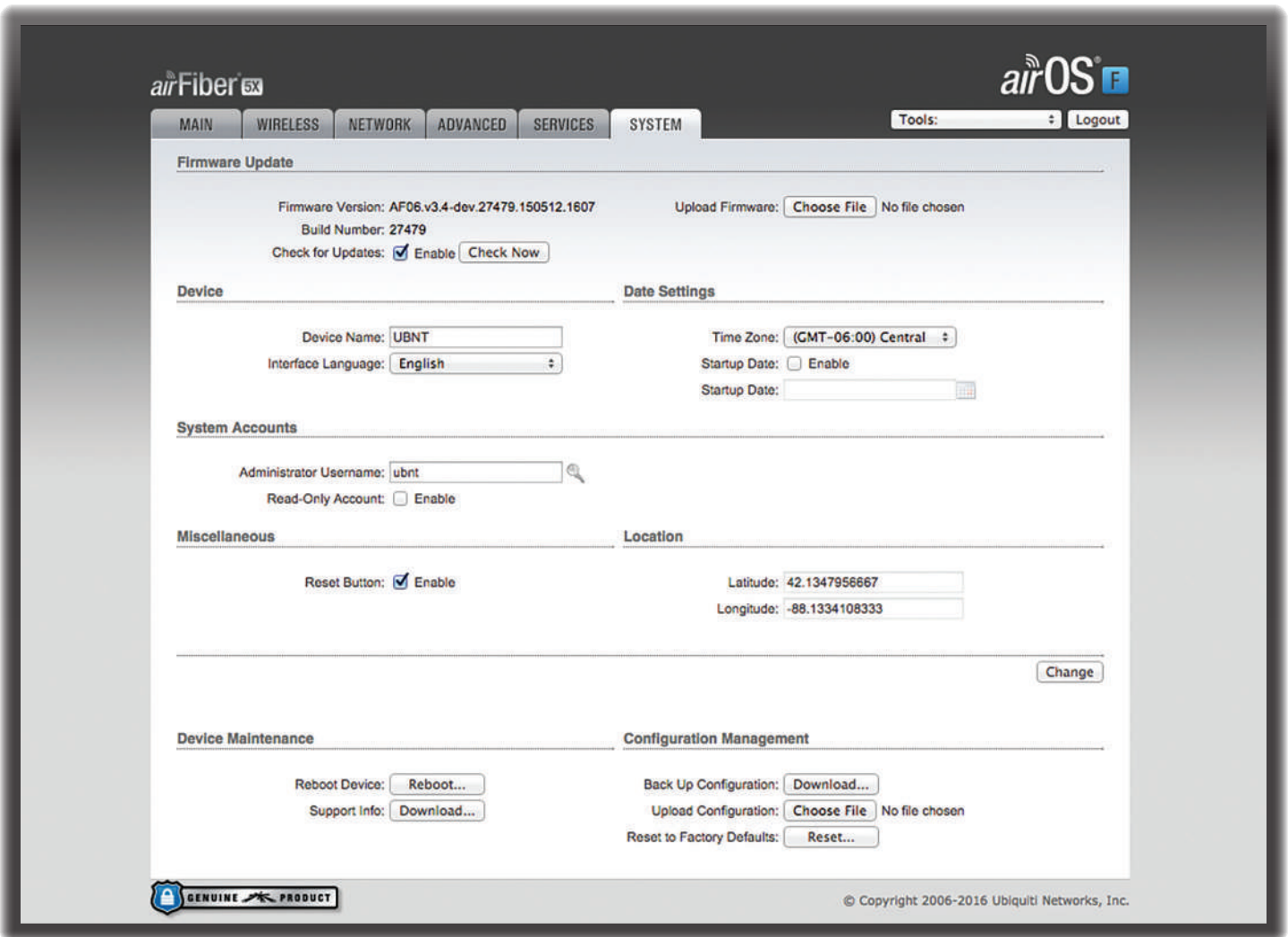

## Chapter 9: System Tab

The *System* tab contains administrative options. This page enables the administrator to reboot the airFiber X radio, reset it to factory defaults, upload new firmware, back up or update the configuration, and configure the administrator account.

**Change** To save or test your changes, click **Change**.

A new message appears. You have three options:

- **Apply** To immediately save your changes, click **Apply**.
- **Test** To try the changes without saving them, click **Test**. To keep the changes, click **Apply**. If you do not click *Apply* within 180 seconds (the countdown is displayed), the airFiber X radio times out and resumes its earlier configuration.
- **Discard** To cancel your changes, click **Discard**.

## Firmware Update

The controls in this section manage firmware maintenance.

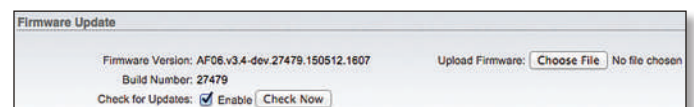

**Firmware Version** Displays the current firmware version.

**Build Number** Displays the build number of the firmware version.

**Check for Updates** By default, the firmware automatically checks for updates. To manually check for an update, click **Check Now**.

**Upload Firmware** Click this button to update the airFiber X radio with new firmware.

The airFiber X radio firmware update is compatible with all configuration settings. The system configuration is preserved while the airFiber X radio is updated with a new firmware version. However, we recommend that you back up your current system configuration before updating the firmware.

This is a three-step procedure:

1. Click **Choose File** to locate the new firmware file. Select the file and click **Open**.
2. Click **Upload** to upload the new firmware to the airFiber X radio.
3. The Uploaded Firmware Version is displayed. Click **Update** to confirm.

If the firmware update is in process, you can close the firmware update window, but this does not cancel the firmware update. Please be patient, as the firmware update routine can take three to seven minutes. You cannot access the airFiber X radio until the firmware update routine is completed.

**! WARNING:** Do not power off, do not reboot, and do not disconnect the airFiber X radio from the power supply during the firmware update process as these actions will damage the airFiber X radio!

## Device

The Device Name (host name) is the system-wide device identifier. The SNMP agent reports it to authorized management stations. The Device Name will be used in popular router operating systems, registration screens, and discovery tools.

**Device Name** Specifies the host name.

**Interface Language** Allows you to select the language displayed in the web management interface. *English* is the default language.

## Date Settings

**Time Zone** Specifies the time zone in relation to Greenwich Mean Time (GMT).

**Startup Date** When enabled, you are able to change the airFiber X radio's startup date.

- **Startup Date** Specifies the airFiber X radio's startup date. Click the **Calendar** icon or manually enter the date in the following format: 2-digit month/2-digit day/4-digit year. For example, for January 5, 2014, enter **01/05/2014** in the field.

## System Accounts

You can change the administrator password to protect your device from unauthorized changes. We recommend that you change the default administrator password when initially configuring the device.

**Administrator Username** Specifies the name of the administrator.

**Key icon** Click this icon to change the administrator password.

- **Current Password** Enter the current password for the administrator account. It is required to change the *Password* or *Administrator Username*.
- **New Password** Enter the new password for the administrator account.
- **Verify New Password** Re-enter the new password for the administrator account.

**Note:** The password length is 8 characters maximum; passwords exceeding 8 characters will be truncated.

**Read-Only Account** Check the box to enable the read-only account, which can only view the *Main* tab. Configure the username and password to protect your device from unauthorized changes.

- **Read-Only Account Name** Specifies the name of the system user.
- **Key icon** Click this icon to change the read-only password.
  - **New Password** Enter the new password for the read-only account.
  - **Show** Check the box to display the read-only password characters.

## Miscellaneous

**Reset Button** To allow use of the airFiber X radio's physical reset button, check the box. To prevent an accidental reset to default settings, uncheck the box.

**Note:** You can reset the airFiber X radio to default settings via the airFiber Configuration Interface. Go to the *System* tab > *Reset to Defaults*.

## Location

After the on-board GPS determines the location of the airFiber X radio, its latitude and longitude are displayed. If the GPS does not have a fix on its location, then “Searching for Satellites” will be displayed.

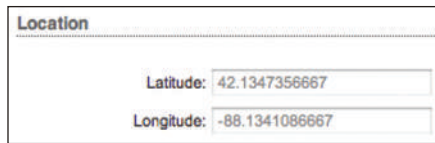

The screenshot shows a window titled "Location" with two input fields. The first field is labeled "Latitude:" and contains the value "42.1347356667". The second field is labeled "Longitude:" and contains the value "-88.1341086667".

**Latitude** The latitude of the airFiber X radio’s location is displayed.

**Longitude** The longitude of the airFiber X radio’s location is displayed.

## Device Maintenance

The controls in this section manage the airFiber X radio maintenance routines: reboot and support information reports.

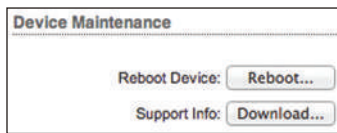

The screenshot shows a window titled "Device Maintenance" with two buttons. The first button is labeled "Reboot Device:" and has a "Reboot..." button next to it. The second button is labeled "Support Info:" and has a "Download..." button next to it.

**Reboot Device** Initiates a full reboot cycle of the airFiber X radio. Reboot is the same as the hardware reboot, which is similar to the power-off and power-on cycle. The system configuration stays the same after the reboot cycle completes. Any changes that have not been applied are lost.

**Support Info** This generates a support information file that the Ubiquiti support engineers can use when providing customer support. This file only needs to be generated at their request.

## Configuration Management

The controls in this section manage the airFiber X radio configuration routines and the option to reset the airFiber X radio to factory default settings.

The airFiber X radio configuration is stored in a plain text file (.cfg file). You can back up, restore, or update the system configuration file:

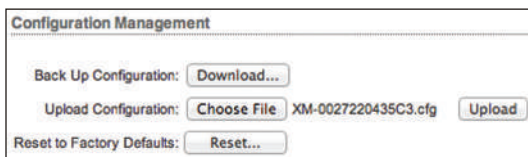

The screenshot shows a window titled "Configuration Management" with three buttons. The first button is labeled "Back Up Configuration:" and has a "Download..." button next to it. The second button is labeled "Upload Configuration:" and has a "Choose File" button, a text field containing "XM-0027220435C3.cfg", and an "Upload" button next to it. The third button is labeled "Reset to Factory Defaults:" and has a "Reset..." button next to it.

**Back Up Configuration** Click **Download** to download the current system configuration file.

**Upload Configuration** Click **Choose File** to locate the new configuration file. Select the file and click **Open**.

We recommend that you back up your current system configuration before uploading the new configuration.

**Upload** Click this button to upload the new configuration file to the airFiber X radio. Click **Apply** to confirm.

After the airFiber X radio reboots, the settings of the new configuration are displayed in the *Wireless, Network, Advanced, Services, and System* tabs of the airFiber Configuration Interface.

**Reset to Factory Defaults** Resets the airFiber X radio to the factory default settings. This option will reboot the airFiber X radio, and all factory default settings will be restored. We recommend that you back up your current system configuration before resetting the airFiber X radio to its defaults.



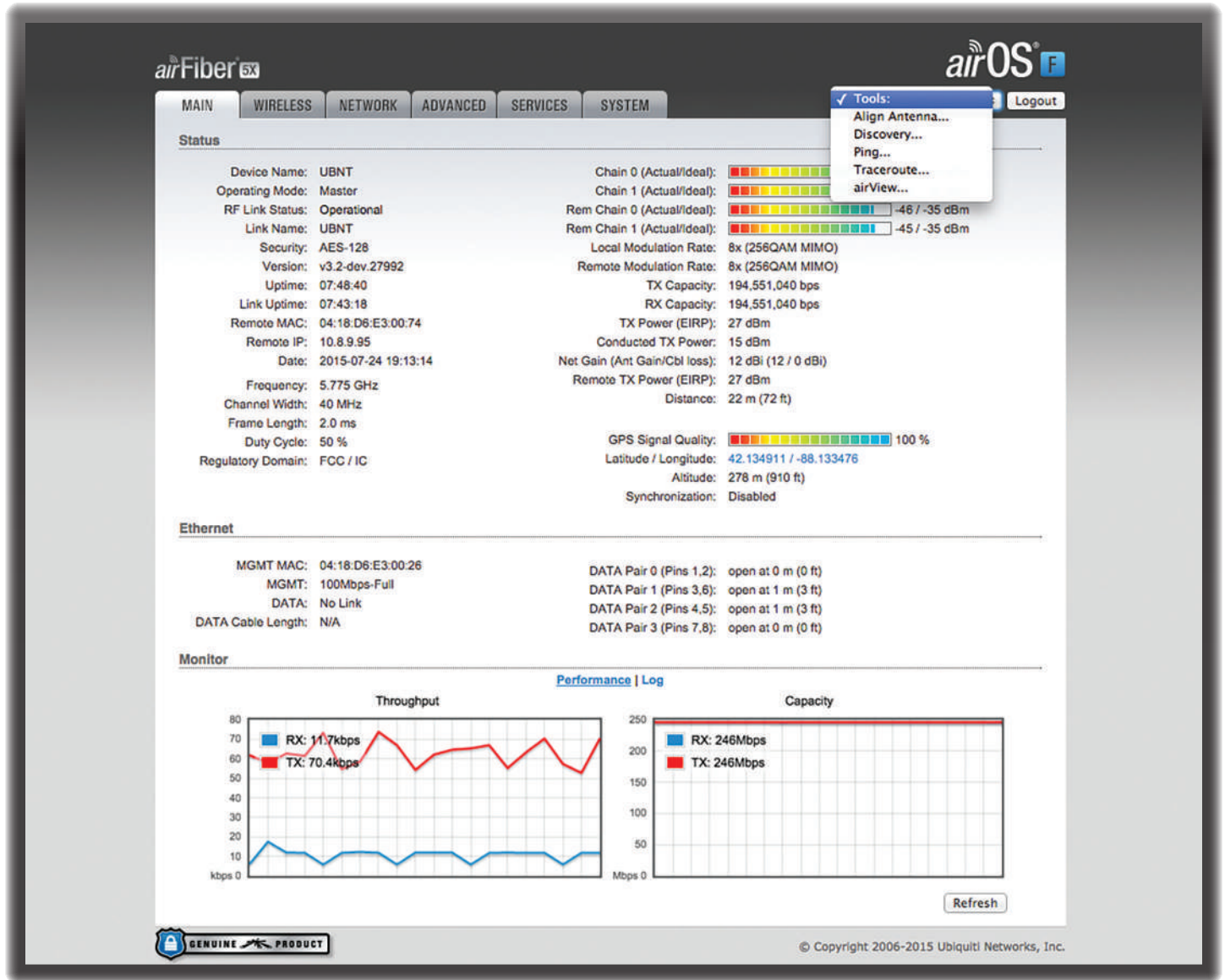

## Chapter 10: Tools

Each tab of the airFiber Configuration Interface contains network administration and monitoring tools. Click the **Tools** drop-down list at the top right corner of the page.

### Align Antenna

Use the *Align Antenna* tool to point and optimize the antenna in the direction of maximum link signal. The *Antenna Alignment* window is designed to refresh every 250 milliseconds.

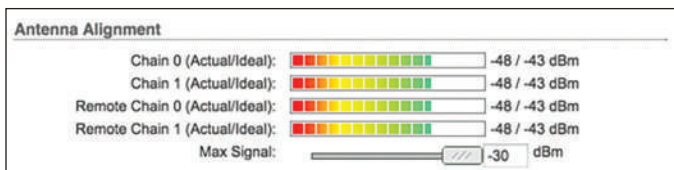

**Chain 0/1 (Actual/Ideal)** Displays the absolute power level (in dBm) of the received signal for each chain.

**Note:** If "Overload" is displayed to indicate an overload condition, identify and eliminate any sources of strong in-band interference.

**Remote Chain 0/1 (Actual/Ideal)** Displays the absolute power level (in dBm) of the received signal for each chain of the remote airFiber X radio.

**Max Signal** Displays the maximum signal strength (in dBm). To adjust the range of the *Max Signal* meter, use the slider or manually enter the new value. If you reduce the range, the color change will be more sensitive to signal fluctuations, indicating the offset of the maximum indicator value and the scale itself.







- **Launch airView** Click **Launch airView** to download the Java Network Launch Protocol (jnlp) file and complete the launch of airView.

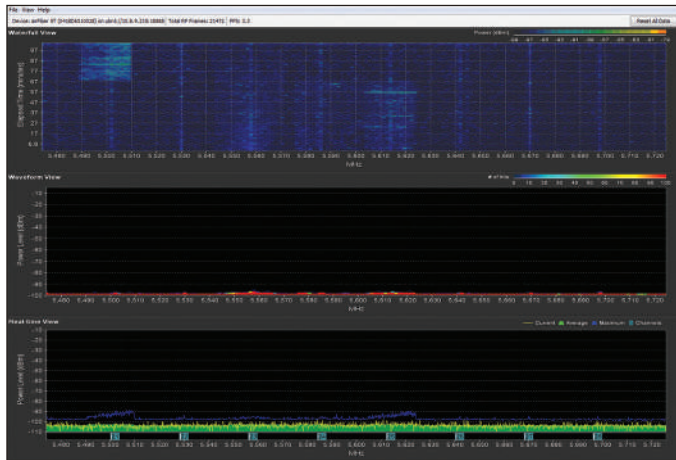
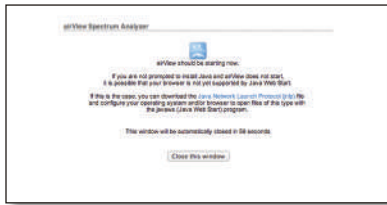

## Main View

**Device** Displays the device name, MAC (Media Access Control) address, and IP address of the device running airView.

**Total RF Frames** Displays the total number of Radio Frequency (RF) frames gathered since the start of the airView session or since the *Reset All Data* button was last clicked.

**FPS** Displays the total number of frames per second (FPS) gathered since the start of the airView session or since the *Reset All Data* button was last clicked. The wider the interval amplitude, the fewer the FPS will be gathered.

**Reset All Data** Click to reset all gathered data. Use this option to analyze the spectrum for another location or address.

## File Menu

Click **Exit** to end the airView session.

## View Menu

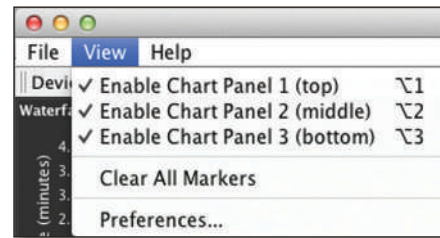

**Enable Chart Panel 1 (top)** Displays the Waterfall or Channel Usage chart in Chart Panel 1, depending on which option you have selected in *Preferences*. This time-based graph shows the aggregate energy collected or channel usage for each frequency since the start of the airView session.

**Enable Chart Panel 2 (middle)** Displays the Waveform chart in Chart Panel 2. This time-based graph shows the RF signature of the noise environment since the start of the airView session. The energy color designates its amplitude. Cooler colors represent lower energy levels (with blue representing the lowest levels) in that frequency bin, and warmer colors (yellow, orange, or red) represent higher energy levels in that frequency bin.

**Enable Chart Panel 3 (bottom)** Displays the Real-time chart (traditional spectrum analyzer) in Chart Panel 3. Energy (in dBm) is shown in real time as a function of frequency.

 **Note:** Energy is the power ratio in decibels (dB) of the measured power referenced to one milliwatt (mW).

**Clear All Markers** Resets all previously assigned markers. Markers are assigned by clicking a point, which corresponds with a frequency on the Real-time chart.

**Preferences** Changes airView settings, such as enabling or disabling charts and traces, or specifying the frequency interval.

## Preferences

Select **View > Preferences** to display the *Preferences - airView Spectrum Analyzer* window.

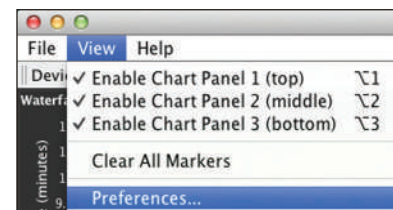

## Charts

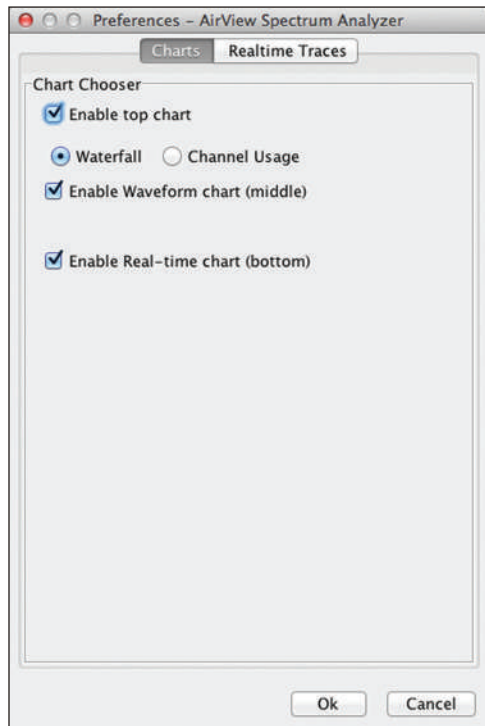

**Enable top chart** Check the box to enable the top chart. Select the desired chart to display in the top chart panel on the main view. There are two options:

- **Waterfall** This time-based graph shows the aggregate energy collected for each frequency since the start of the airView session. The energy color designates its amplitude. Cooler colors represent lower energy levels (with blue representing the lowest levels) in that frequency bin, and warmer colors (yellow, orange, or red) represent higher energy levels in that frequency bin.

The Waterfall View's legend (top-right corner) provides a numerical guide associating the various colors to power levels (in dBm). The low end of that legend (left) is always adjusted to the calculated noise floor, and the high end (right) is set to the highest detected power level since the start of the airView session.

- **Channel Usage** For each channel, a bar displays a percentage showing the relative "crowdedness" of that specific channel. To calculate this percentage, the airView Spectrum Analyzer analyzes both the popularity and strength of RF energy in that channel since the start of an airView session.



**Note:** airFiber X radio channels are not related to Wi-Fi channels which are determined by IEEE standards. airFiber X radio channels are numbered consecutively starting with 0 and are 28 MHz in width.

**Enable Waveform chart (middle)** Check the box to enable the middle chart. This time-based graph shows the RF signature of the noise environment since the start of the airView session. The energy color designates its amplitude. Cooler colors represent lower energy levels (with blue representing the lowest levels) in that frequency bin, and warmer colors (yellow, orange, or red) represent higher energy levels in that frequency bin.

The spectral view over time will display the steady-state RF energy signature of a given environment.

**Enable Real-time chart (bottom)** Check the box to enable the bottom chart. This graph displays a traditional spectrum analyzer in which energy (in dBm) is shown in real time as a function of frequency. There are three traces in this view:

- **Current** (Yellow) Shows the real-time energy seen by the device as a function of frequency.
- **Average** (Green) Shows the running average energy across frequency.
- **Maximum** (Blue) Shows updates and maximum power levels across frequency.

## Real-Time Traces

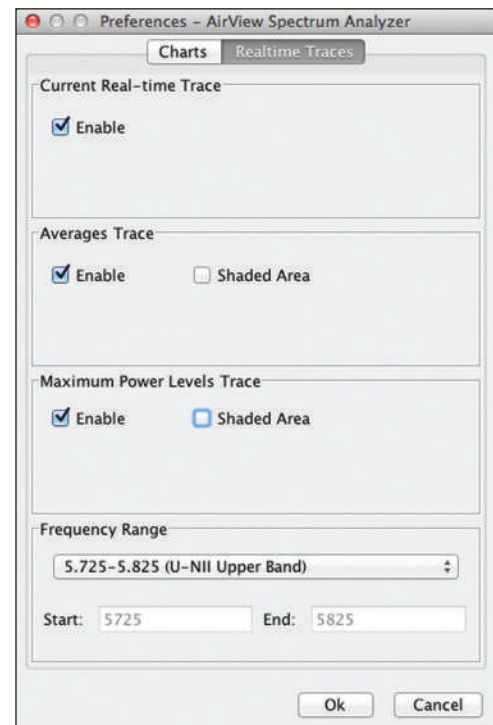

The following settings apply only to the *Real-time* chart:

**Current Real-time Trace** Check the *Enable* box to enable the real-time trace. When enabled, the yellow outline on the *Real-time* chart represents the real-time power level of each frequency. The refresh speed depends on the FPS.

**Averages Trace** Check the *Enable* box to enable the averages trace. When enabled, the averages trace is represented by the green area on the *Real-time* chart, which displays the average received power level data since the start of the airView session. To enable a shaded green area, check the *Shaded Area* box. To display only a green outline without the shaded area, uncheck the *Shaded Area* box.

**Maximum Power Levels Trace** Check the *Enable* box to enable the maximum power trace. When enabled, the maximum power trace is represented by the blue area on the *Real-time* chart, which displays the maximum received power level data since the start of the airView session. To enable a shaded blue area, check the *Shaded Area* box. To display only a blue outline without the shaded area, uncheck the *Shaded Area* box.

**Frequency Range** Select the amplitude of the frequency interval to be scanned from the *Frequency Range* drop-down list. Available frequencies are device-dependent. There are pre-defined ranges for the most popular bands. You can enter a custom range; select **Custom Range** from the *Frequency Range* drop-down list and enter the desired values in the *Start* and *End* fields.



## Appendix A: Specifications

airFiber AF-2X	
Dimensions	224 x 82 x 48 mm (8.82 x 3.23 x 1.89")
Weight	0.35 kg (0.77 lb)
RF Connectors	(2) RP-SMA Weatherproof (CH0, CH1) (1) SMA Weatherproof (GPS)
GPS Antenna	External, Magnetic Base
Power Supply	24V, 1A PoE Gigabit Adapter (Included)
Power Method	Passive Power over Ethernet Pins 1, 2, 4, 5 (+) and Pins 7, 8, 3, 6 (-)
Max. Power Consumption	17W @ Max. Power/Duty Cycle
Mounting	airFiber X Mount (Rocket Mount Compatible) GPS Pole Mount (Included)
Certifications	CE, FCC, IC
Operating Temperature	-40 to 55° C (-40 to 131° F)

AF-2X Networking Interface	
Data Port	(1) 10/100/1000 Ethernet Port
Management Port	(1) 10/100 Ethernet Port

AF-2X System	
Maximum Throughput	500+ Mbps <sup>1</sup>
Maximum Range	200+ km <sup>1</sup>
Encryption	128-bit AES
OS	airOS F
Wireless Modes	Master/Slave

AF-2X Radio	
Frequency Range	2400-2500 MHz (Depends on Regulatory Region) <sup>2</sup>
Max. Conducted TX Power	30 dBm <sup>2</sup> (Depends on Regulatory Region)
Frequency Accuracy	± 2.5 ppm without GPS Synchronization ± 0.2 ppm with GPS Synchronization
Channel Bandwidth	3.5/5/7/10/14/20/28/30/40/50/56 MHz Selectable <sup>3</sup> Programmable Uplink and Downlink Duty Cycles Independently Programmable TX and RX Frequencies

<sup>1</sup> Throughput and range values may vary depending on the environmental conditions.

<sup>2</sup> For region-specific details, refer to "**Frequency Ranges and Power Levels per Country/Region**" on page 53.

<sup>3</sup> Channel widths may vary according to country/region regulations.

airFiber AF-3X	
Dimensions	224 x 82 x 48 mm (8.82 x 3.23 x 1.89")
Weight	0.35 kg (0.77 lb)
RF Connectors	(2) RP-SMA Weatherproof (CH0, CH1) (1) SMA Weatherproof (GPS)
GPS Antenna	External, Magnetic Base
Power Supply	24V, 1A PoE Gigabit Adapter (Included)
Power Method	Passive Power over Ethernet Pins 1, 2, 4, 5 (+) and Pins 7, 8, 3, 6 (-)
Max. Power Consumption	17W @ Max. Power/Duty Cycle
Mounting	airFiber X Mount (Rocket Mount Compatible) GPS Pole Mount (Included)
Certifications	CE, FCC, IC
Operating Temperature	-40 to 55° C (-40 to 131° F)

AF-3X Networking Interface	
Data Port	(1) 10/100/1000 Ethernet Port
Management Port	(1) 10/100 Ethernet Port

AF-3X System	
Maximum Throughput	500+ Mbps <sup>1</sup>
Maximum Range	200+ km <sup>1</sup>
Encryption	128-bit AES
OS	airOS F
Wireless Modes	Master/Slave

AF-3X Radio	
Frequency Range	3300-3900 MHz (Depends on Regulatory Region) <sup>2</sup>
Max. Conducted TX Power	29 dBm <sup>2</sup> (Depends on Regulatory Region)
Frequency Accuracy	± 2.5 ppm without GPS Synchronization ± 0.2 ppm with GPS Synchronization
Channel Bandwidth	3.5/5/7/10/14/20/28/30/40/50/56 MHz Selectable <sup>3</sup> Programmable Uplink and Downlink Duty Cycles Independently Programmable TX and RX Frequencies

<sup>1</sup> Throughput and range values may vary depending on the environmental conditions.

<sup>2</sup> For region-specific details, refer to "**Frequency Ranges and Power Levels per Country/Region**" on page 53.

<sup>3</sup> Channel widths may vary according to country/region regulations.



airFiber AF-4X	
Dimensions	224 x 82 x 48 mm (8.82 x 3.23 x 1.89")
Weight	0.35 kg (0.77 lb)
RF Connectors	(2) RP-SMA Weatherproof (CH0, CH1) (1) SMA Weatherproof (GPS)
GPS Antenna	External, Magnetic Base
Power Supply	24V, 1A PoE Gigabit Adapter (Included)
Power Method	Passive Power over Ethernet Pins 1, 2, 4, 5 (+) and Pins 7, 8, 3, 6 (-)
Max. Power Consumption	12W
Mounting	airFiber X Mount (Rocket Mount Compatible) GPS Pole Mount (Included)
Certifications	CE, FCC, IC
Operating Temperature	-40 to 55° C (-40 to 131° F)

AF-4X Networking Interface	
Data Port	(1) 10/100/1000 Ethernet Port
Management Port	(1) 10/100 Ethernet Port

AF-4X System	
Maximum Throughput	500+ Mbps <sup>1</sup>
Maximum Range	200+ km <sup>1</sup>
Encryption	128-bit AES
OS	airOS F
Wireless Modes	Master/Slave

AF-4X Radio	
Frequency Range	
FCC	4940 - 4990 MHz
IC	4940 - 4990 MHz
ETSI	4700 - 4990 MHz <sup>2</sup>
Other Regions	4700 - 4990 MHz <sup>2</sup>
Max. Conducted TX Power	29 dBm <sup>2</sup> (Depends on Regulatory Region)
Frequency Accuracy	± 2.5 ppm without GPS Synchronization ± 0.2 ppm with GPS Synchronization
Channel Bandwidth	3.5/5/7/10/14/20/28/30/40/50/56 MHz Selectable <sup>3</sup> Programmable Uplink and Downlink Duty Cycles

<sup>1</sup> Throughput and range values may vary depending on the environmental conditions.

<sup>2</sup> For region-specific details, refer to "**Frequency Ranges and Power Levels per Country/Region**" on page 53.

<sup>3</sup> Channel widths may vary according to country/region regulations.

airFiber AF-5X	
Dimensions	224 x 82 x 48 mm (8.82 x 3.23 x 1.89")
Weight	0.35 kg (0.77 lb)
RF Connectors	(2) RP-SMA Weatherproof (CH0, CH1) (1) SMA Weatherproof (GPS)
GPS Antenna	External, Magnetic Base
Power Supply	24V, 1A PoE Gigabit Adapter (Included)
Power Method	Passive Power over Ethernet Pins 1, 2, 4, 5 (+) and Pins 7, 8, 3, 6 (-)
Max. Power Consumption	12W
Mounting	airFiber X Mount (Rocket Mount Compatible) GPS Pole Mount (Included)
Certifications	CE, FCC, IC
Operating Temperature	-40 to 55° C (-40 to 131° F)

AF-5X Networking Interface	
Data Port	(1) 10/100/1000 Ethernet Port
Management Port	(1) 10/100 Ethernet Port

AF-5X System	
Maximum Throughput	500+ Mbps <sup>1</sup>
Maximum Range	200+ km <sup>1</sup>
Encryption	128-bit AES
OS	airOS F
Wireless Modes	Master/Slave

AF-5X Radio	
Frequency Range FCC 15.407 IC RSS-210 ETSI EN 301 893, EN 302 502 Other Regions	5150-5350 MHz, 5470-5850 MHz 5470-5600 MHz, 5650-5850 MHz 5470-5875 MHz 5150-5950 MHz <sup>2</sup>
Max. Conducted TX Power	26 dBm <sup>2</sup> (Depends on Regulatory Region)
Frequency Accuracy	± 2.5 ppm without GPS Synchronization ± 0.2 ppm with GPS Synchronization
Channel Bandwidth	10 MHz, 20 MHz, 30 MHz, 40 MHz, 50 MHz Selectable Programmable Uplink and Downlink Duty Cycles

<sup>1</sup> Throughput and range values may vary depending on the environmental conditions.

<sup>2</sup> For region-specific details, refer to "**Frequency Ranges and Power Levels per Country/Region**" on page 53.

## Appendix B: AF-5X and airFiber Multiplexer

**Note:** This appendix applies to the airFiber AF-5X radio when used with the airFiber NxN Multiplexer.

The following provides important information for using the AF-5X radio with the airFiber NxN Multiplexer (models AF-MPx4 or AF-MPx8). For a successful deployment, ensure that all additional steps are taken and that all information is taken into consideration.

- During initial configuration of each AF-5X radio, input the additional cable loss associated with the multiplexer, and enable the *NxN Radio* setting. For details, refer to Step 6 of **“airFiber Configuration” on page 4**.
- When performing antenna alignment, perform the procedure in **“Establishing a Link” on page 9** on one radio only. This will help ensure maximum success in registrations.
- After the first radio has been aligned with the other side of the link, ensure that the TX power balance is present.
- To maintain 8x performance, maximum TX power should not exceed 19-20 dBm.
- If 8x performance cannot be achieved at these TX power levels, it may be possible to improve performance by increasing channel spacing.

### airFiber X Compatibility

The airFiber NxN is designed for use with airFiber 5X radios (model AF-5X) and 5 GHz airFiber X or RocketDish™ antennas.

**Note:** The airFiber X Antenna OMT Conversion Kit (AF-5G-OMT-S45) is highly recommended when using a RocketDish for proper fitting and improved frequency isolation.

### Installation Requirements

- (2) airFiber 5X radios for AF-MPx4
- (4) airFiber 5X radios for AF-MPx8
- airFiber X or RocketDish antenna
- Clear view of the sky for proper GPS operation
- Ground wires – min. 10 AWG (5 mm<sup>2</sup>) and max. length: 1 m. As a safety precaution, ground the airFiber radios to grounded masts, poles, towers, or grounding bars.

**WARNING:** Failure to properly ground your airFiber radio will void your warranty.

**Note:** For guidelines about grounding and lightning protection, follow your local electrical regulatory codes.

- Outdoor, shielded Category 6 (or above) cabling and shielded RJ-45 connectors are required for all wired Ethernet connections.

## Hardware Overview

### airFiber NxN Multiplexer

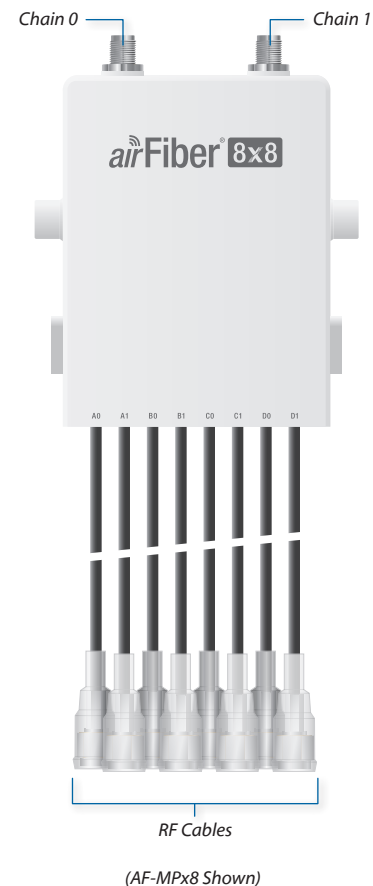

**Chain 0** Connect the antenna RF +45° to this connector.

**Chain 1** Connect the antenna RF -45° to this connector.

**RF Cables** Connect each *RF Cable* pair to the corresponding RF connection chain on each airFiber 5X radio. For example, connect cable **A0** to **Chain 0**, and cable **A1** to **Chain 1**.

## Configure the airFiber 5X Radio

**Note:** The airFiber 5X radios must be running airOS®F v3.2.1 or newer. The latest firmware is available at: [downloads.ubnt.com/airfiber](http://downloads.ubnt.com/airfiber)

Each airFiber 5X radio must be preconfigured for use with the airFiber NxN before installing them at the site.

Enable airFiber NxN support on each radio:

1. Log into the airOS F Configuration Interface.
2. Click the **Wireless** tab.
3. Enter the additional *Cable Loss* value (dB):
  - a. **4.1** for the AF-MPx4, or
  - b. **7.2** for the AF-MPx8
4. For the *NxN Radio* setting, select **Enable**.

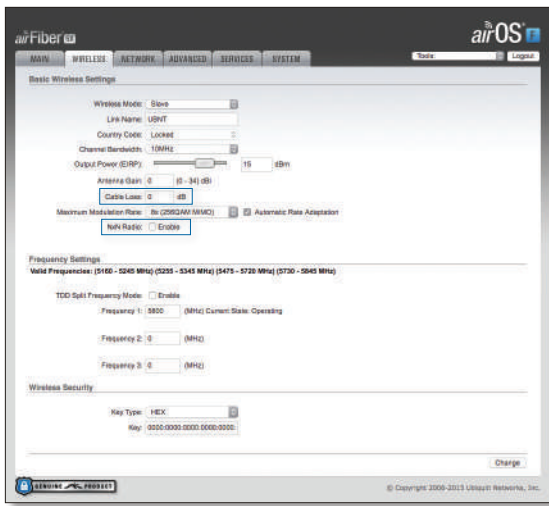

5. Click **Change**, and then click **Apply**.

## Hardware Installation

The following installation shows the AF-MPx8. For the AF-MPx4 installation, only the mounting and connecting of two airFiber 5X radios apply.

1. (For AF-MPx8 only) Attach the *8x8 Radio Bracket* to the *4x4 Radio Bracket* using four *M3x8 Screws*.

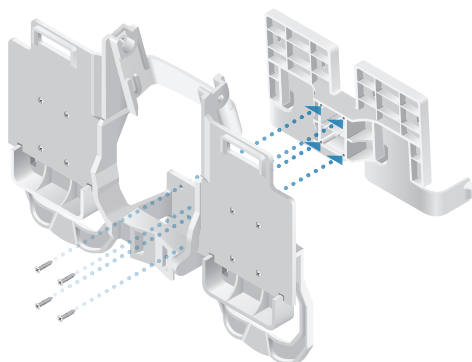

2. Seat the *airFiber NxN Multiplexer* into the *4x4 Radio Bracket* either at (a) a 15° angle or (b) vertically:

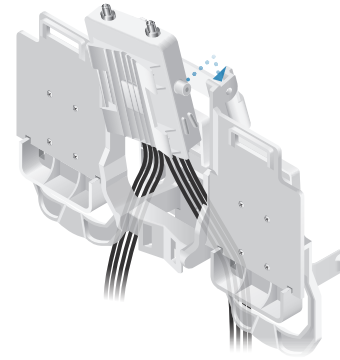

- a. For most antenna models, the *airFiber NxN Multiplexer* should be installed at a 15° angle. Insert the *airFiber NxN Multiplexer* from behind the *4x4 Radio Bracket* and slide the *15° Angle Tabs* into the slots on the bracket.

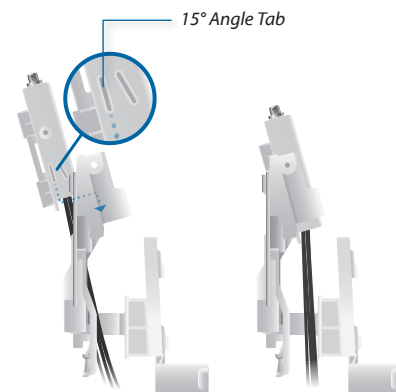

- b. For other antenna configurations that require the *airFiber NxN assembly* to be mounted to a pole, the *airFiber NxN Multiplexer* must be installed vertically. Insert the *airFiber NxN Multiplexer* from behind the *4x4 Radio Bracket* and slide the *Vertical Tabs* into the slots on the bracket.

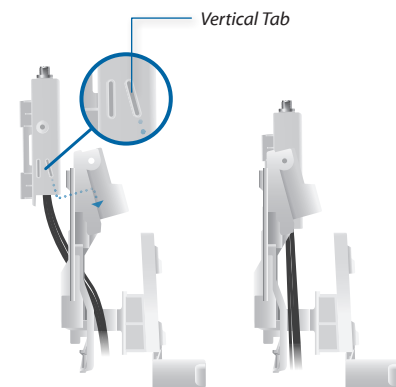

3. Secure the *airFiber NxN Multiplexer* to the *4x4 Radio Bracket* using two *M4x12 Screws*.

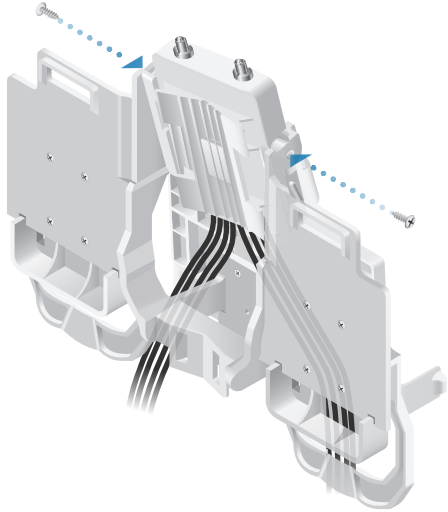

**Note:** Ensure the airFiber 5X radios are preconfigured and the ground wires are installed as outlined in the radio's Quick Start Guide before mounting the radios.

4. Mount the airFiber 5X radios to the *4x4 Radio Bracket*:
  - a. Align the mounting tabs on the back of the radio with the mounting bracket.
  - b. Slide the radio down to lock it into place.



5. Mount the airFiber 5X radios to the *8x8 Radio Bracket*:
  - a. Align the mounting tabs on the back of the radio with the mounting bracket.
  - b. Slide the radio down to lock it into place.



6. Connect the *RF Cables* to the airFiber 5X radios. Connect each *RF Cable* pair to the corresponding RF connection chain on each radio. For example, connect cable **A0** to **Chain 0**, and cable **A1** to **Chain 1**.



7. Attach the airFiber NxN assembly to the airFiber X or RocketDish antenna:
  - a. Align the mounting tabs on the back of the *airFiber NxN Multiplexer* with the mounting bracket.
  - b. Slide the *airFiber NxN Multiplexer* down to lock it into place on the bracket.

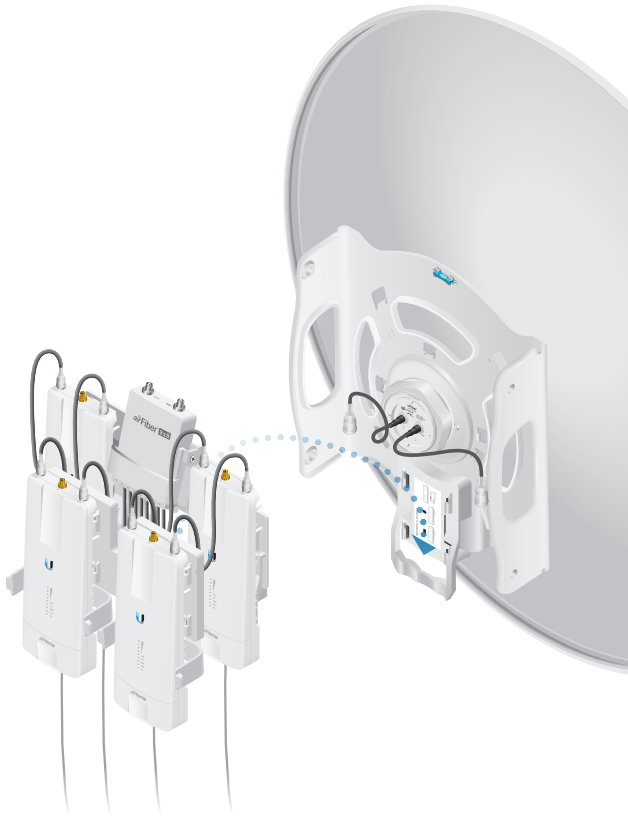

**Note:** The airFiber NxN assembly may be pole-mounted if it cannot be attached to the antenna. See the Pole-Mounting section for details.

8. Connect the RF cables from the antenna to the RF connectors on the *airFiber NxN Multiplexer*. Connect +45° to *Chain 0* and -45° to *Chain 1*.



9. Attach the GPS antennas to each of the airFiber 5X radios.
10. Mount the GPS antennas in a location that has a clear view of the sky, and is above and as far away from the radios as possible.



11. Attach the *Protective Shrouds*:

- a. Insert the *Protective Shroud's* attachment tab between the airFiber 5X radio and the *4x4 Radio Bracket*.
- b. Push the *Protective Shroud* down until the attachment tab locks into place.

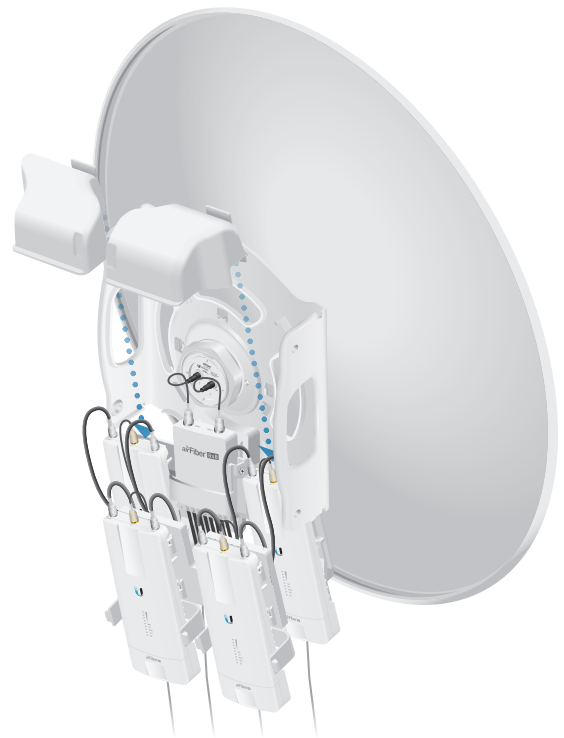

12. Secure the grounding wire from each radio to a grounded mast, pole, tower, or grounding bar.



**WARNING:** Failure to properly ground your airFiber radio will void your warranty.



**Note:** The ground wire should be as short as possible and no longer than one meter in length.



## Pole-Mounting

1. Ensure the *airFiber NxN Multiplexer* is installed vertically in the *4x4 Radio Bracket*.
2. Mount the airFiber NxN assembly to the pole using two metal straps (not included):
  - a. Insert a metal strap through each mounting bracket on the back of the *airFiber NxN Multiplexer* and *4x4 Radio Bracket*.
  - b. Secure both straps around the pole.

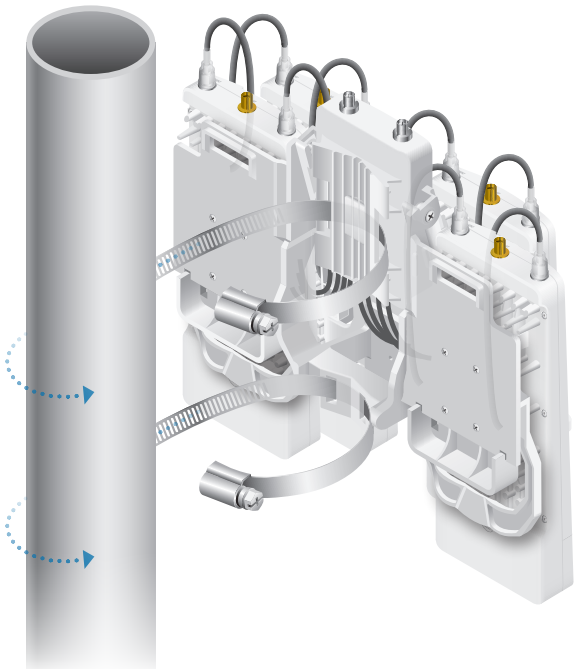

3. Connect the RF cables from the antenna to the RF connectors on the *airFiber NxN Multiplexer*. Connect +45° to *Chain 0* and -45° to *Chain 1*.



## Appendix C: Listen Before Talk



**Note:** This appendix applies to the airFiber AF-3X radio only.

### Introduction

Listen Before Talk (LBT) is a requirement for the 3.6 GHz band in North America and Canada.

Because exclusive licenses for the 3650-3700 MHz band are not granted within the United States, operators must take steps to minimize potential interference in this band.

LBT refers to a contention-based protocol (CBP) that requires a device to check if the transmission channel is in use (listen) before it can initiate a transmission (talk). FCC standards that relate to LBT include the following:

- FCC Part 90, Subpart Z requires 3.6 GHz systems to implement a contention-based protocol to provide LBT capability. This same requirement has also been adopted by Industry Canada (IC).
- FCC Part 90, Subpart Z defines two categories of contention-based protocols, *restricted* and *unrestricted*:
  - **Restricted contention-based protocol** This is a protocol that can detect interference from products that use a similar contention technology. Systems using a restricted contention-based protocol operate in the lower 25 MHz of the frequency band (3650-3675 MHz).
  - **Unrestricted contention-based protocol** This is a protocol that can detect interference from products that use a dissimilar contention technology. Systems using an unrestricted contention-based protocol use the full 50 MHz (3650-3700 MHz) of the frequency band.

### Unrestricted Protocol Description

The AF-3X Master/Slave system uses dedicated logic for the LBT protocol, which is embedded into a TDD frame structure. Energy detection is done at the beginning of the TX defined by the frame structure of the air interface, at intervals of 2.0, 2.5, 4.0, or 5.0 ms for compatibility between various other Part 90Z radio devices.

### Threshold Detection To Determine Occupancy

The AF-3X averages the energy detected over a fixed listen time and compares it to a preconfigured threshold value. This threshold is configured for values that are within the linear portion of the radio's Receive Signal Strength Indicator (RSSI) dynamic range.

The energy detection threshold is proportional to the transmitter's maximum transmit power. For example, if the transmitter's EIRP is 23 dBm, then the detection threshold at the receiver's input (assuming antenna gain of 0 dBi) is -73 dBm/MHz.

The detection threshold is adjusted as follows:

$$DT = -73 \text{ dBm/MHz} + 10\log_{10}(B) + 23 - P_T + A$$

where:

- DT = Detection Threshold in dBm
- B = Monitored bandwidth in MHz
- $P_T$  = Maximum transmit power in dBm EIRP
- A = Receive antenna gain in dBi

The receive antenna gain A is set equal to the external antenna gain. The following are set by the operator during the configuration of the AF-3X radio:

- maximum desired EIRP power  $P_T$
- external antenna gain A
- channel bandwidth B

The AF-3X ensures that the sum of the actual conducted power and the external antenna gain used to calculate  $P_T$  does not exceed the regulatory EIRP limit.

The Master/Slave device makes an average measurement during its Tx and samples the channel every frame (typically 2.0 ms) to accumulate a co-channel signal measurement. A typical accumulation period is 5  $\mu$ s.

The bandwidth used for all channel occupancy measurements is the same bandwidth used for system operation and is configurable for values that range from 3.5 MHz to 40 MHz.

The detection threshold is configured to scale automatically based on the in-use modulation level that the system negotiates. The threshold level is automatically set by the radio to meet regulatory requirements. All threshold levels are normalized to a 0 dBi reference level.

The detection system uses the same hardware as the actual radio lower-level software code and is therefore operational over the same power range.

The AF-3X point-to-point system employs a proprietary media access layer (MAC) that utilizes a TDD scheduled transmission which is synchronized. Both the Master and Slave employ a threshold detection mechanism to monitor for other systems running within a selected channel.

### Action Taken When Occupancy is Determined

Upon detection of occupancy, the Master will cease transmission. It will continue to monitor the channel to see if at any point that it becomes available.

Hidden-node problems are avoided by the AF-3X system's proprietary media access control (MAC) layer that utilizes a TDD scheduled transmission (a synchronized framed transmission). The Slave device cannot transmit until it is allocated bandwidth from the Master device. If the Master device detects co-channel signals, the uplink for the scheduled slot allocation is not granted to the Slave, preventing the Slave from transmitting. Since permission to transmit is granted by the Master, there is no hidden node problem like that experienced by Wi-Fi systems which employ a contention-based protocol.

## Opportunities for Other Transmitters to Operate

No differences are performed between start-up mode and operational mode. The Master/Slave device goes into an energy scanning mode where it is allowed to do one full cycle of energy detection before it is allowed to transmit. The scan is a mode where the average energy is accumulated to compare against the programmed detection threshold. If the energy detected is less than the detection threshold, the Master/Slave device is allowed to make a transmission.

In normal operational mode the system does not allow any transmission once the threshold has been detected. Once the energy is no longer present will the system begin to transmit again.

The Master and Slave uses the energy detected prior to each transmit frame to control the muting of the transmit function.

At any load level (no load, typical, or overload), the system transmits data based on the configuration for the uplink/downlink ratio. The same amount of bandwidth is reserved for channel detection, so performance remains unaffected.

If there are two AF-3X systems on a co-channel, they would share the spectrum as follows:

- Since the system is a synchronized frame-based system, both systems would operate effectively with each other because each system can be configured to transmit and receive at the same point in time. The system uses a GPS synchronization to time-align the start-of-frame for all systems deployed.
- If the users configure the number of uplink and downlink slots and the duty cycle (uplink/downlink ratio) in an identical manner and each system uses the same set of uncommitted uplink slots for the detection sampling interval, then the two systems will co-exist with no knowledge of the others presence.
- Each system listens prior to transmit and if it detects activity yields to the other system.
- The system will shut down when the accumulated energy is above the detection threshold and will continue to transmit if it is below the detection threshold. When the co-channel system is clear of the channel then the target system will go back into regular operation. Regular operation will consist of a constant averaging of the energy detected in the uplink slots.

## Appendix D: Safety Notices

---

1. Read, follow, and keep these instructions.
2. Heed all warnings.
3. Only use attachments/accessories specified by the manufacturer.

 **WARNING:** Do not use this product in location that can be submerged by water.

 **WARNING:** Avoid using this product during an electrical storm. There may be a remote risk of electric shock from lightning.

### Electrical Safety Information

1. Compliance is required with respect to voltage, frequency, and current requirements indicated on the manufacturer's label. Connection to a different power source than those specified may result in improper operation, damage to the equipment or pose a fire hazard if the limitations are not followed.
2. There are no operator serviceable parts inside this equipment. Service should be provided only by a qualified service technician.
3. This equipment is provided with a detachable power cord which has an integral safety ground wire intended for connection to a grounded safety outlet.
  - a. Do not substitute the power cord with one that is not the provided approved type. Never use an adapter plug to connect to a 2-wire outlet as this will defeat the continuity of the grounding wire.
  - b. The equipment requires the use of the ground wire as a part of the safety certification, modification or misuse can provide a shock hazard that can result in serious injury or death.
  - c. Contact a qualified electrician or the manufacturer if there are questions about the installation prior to connecting the equipment.
  - d. Protective earthing is provided by Listed AC adapter. Building installation shall provide appropriate short-circuit backup protection.
  - e. Protective bonding must be installed in accordance with local national wiring rules and regulations.





## Appendix E: Warranty

### Limited Warranty

UBIQUITI NETWORKS, Inc (“UBIQUITI NETWORKS”) warrants that the product(s) furnished hereunder (the “Product(s)”) shall be free from defects in material and workmanship for a period of one (1) year from the date of shipment by UBIQUITI NETWORKS under normal use and operation. UBIQUITI NETWORKS’ sole and exclusive obligation and liability under the foregoing warranty shall be for UBIQUITI NETWORKS, at its discretion, to repair or replace any Product that fails to conform to the above warranty during the above warranty period. The expense of removal and reinstallation of any Product is not included in this warranty. The warranty period of any repaired or replaced Product shall not extend beyond its original term.

### Warranty Conditions

The above warranty does not apply if the Product:

- (I) has been modified and/or altered, or an addition made thereto, except by Ubiquiti Networks, or Ubiquiti Networks’ authorized representatives, or as approved by Ubiquiti Networks in writing;
- (II) has been painted, rebranded or physically modified in any way;
- (III) has been damaged due to errors or defects in cabling;
- (IV) has been subjected to misuse, abuse, negligence, abnormal physical, electromagnetic or electrical stress, including lightning strikes, or accident;
- (V) has been damaged or impaired as a result of using third party firmware;
- (VI) has no original Ubiquiti MAC label, or is missing any other original Ubiquiti label(s); or
- (VII) has not been received by Ubiquiti within 30 days of issuance of the RMA.

In addition, the above warranty shall apply only if: the product has been properly installed and used at all times in accordance, and in all material respects, with the applicable Product documentation; all Ethernet cabling runs use CAT5 (or above), and for outdoor installations, shielded Ethernet cabling is used, and for indoor installations, indoor cabling requirements are followed.

 **WARNING: Failure to properly ground your airFiber units will void your warranty.** (Please follow the instructions on **“Install a Ground Wire”** on page 5 for installation of the ground wires.)

### Returns

No Products will be accepted for replacement or repair without obtaining a Return Materials Authorization (RMA) number from UBIQUITI NETWORKS during the warranty period, and the Products being received at UBIQUITI NETWORKS’ facility freight prepaid in accordance with the RMA process of UBIQUITI NETWORKS. Products returned without an RMA number will not be processed and will be returned freight collect or subject to disposal. Information on the RMA process and obtaining an RMA number can be found at: [www.ubnt.com/support/warranty](http://www.ubnt.com/support/warranty).

### Disclaimer

EXCEPT FOR ANY EXPRESS WARRANTIES PROVIDED HEREIN, UBIQUITI NETWORKS, ITS AFFILIATES, AND ITS AND THEIR THIRD PARTY DATA, SERVICE, SOFTWARE AND HARDWARE PROVIDERS HEREBY DISCLAIM AND MAKE NO OTHER REPRESENTATION OR WARRANTY OF ANY KIND, EXPRESS, IMPLIED OR STATUTORY, INCLUDING, BUT NOT LIMITED TO, REPRESENTATIONS, GUARANTEES, OR WARRANTIES OF MERCHANTABILITY, ACCURACY, QUALITY OF SERVICE OR RESULTS, AVAILABILITY, SATISFACTORY QUALITY, LACK OF VIRUSES, QUIET ENJOYMENT, FITNESS FOR A PARTICULAR PURPOSE AND NON-INFRINGEMENT AND ANY WARRANTIES ARISING FROM ANY COURSE OF DEALING, USAGE OR TRADE PRACTICE IN CONNECTION WITH SUCH PRODUCTS AND SERVICES. BUYER ACKNOWLEDGES THAT NEITHER UBIQUITI NETWORKS NOR ITS THIRD PARTY PROVIDERS CONTROL BUYER’S EQUIPMENT OR THE TRANSFER OF DATA OVER COMMUNICATIONS FACILITIES, INCLUDING THE INTERNET, AND THAT THE PRODUCTS AND SERVICES MAY BE SUBJECT TO LIMITATIONS, INTERRUPTIONS, DELAYS, CANCELLATIONS AND OTHER PROBLEMS INHERENT IN THE USE OF COMMUNICATIONS FACILITIES. UBIQUITI NETWORKS, ITS AFFILIATES AND ITS AND THEIR THIRD PARTY PROVIDERS ARE NOT RESPONSIBLE FOR ANY INTERRUPTIONS, DELAYS, CANCELLATIONS, DELIVERY FAILURES, DATA LOSS, CONTENT CORRUPTION, PACKET LOSS, OR OTHER DAMAGE RESULTING FROM ANY OF THE FOREGOING. In addition, UBIQUITI NETWORKS does not warrant that the operation of the Products will be error-free or that operation will be uninterrupted. In no event shall UBIQUITI NETWORKS be responsible for damages or claims of any nature or description relating to system performance, including coverage, buyer’s selection of products (including the Products) for buyer’s application and/or failure of products (including the Products) to meet government or regulatory requirements.

## Limitation of Liability

EXCEPT TO THE EXTENT PROHIBITED BY LOCAL LAW, IN NO EVENT WILL UBIQUITI OR ITS SUBSIDIARIES, AFFILIATES OR SUPPLIERS BE LIABLE FOR DIRECT, SPECIAL, INCIDENTAL, CONSEQUENTIAL OR OTHER DAMAGES (INCLUDING LOST PROFIT, LOST DATA, OR DOWNTIME COSTS), ARISING OUT OF THE USE, INABILITY TO USE, OR THE RESULTS OF USE OF THE PRODUCT, WHETHER BASED IN WARRANTY, CONTRACT, TORT OR OTHER LEGAL THEORY, AND WHETHER OR NOT ADVISED OF THE POSSIBILITY OF SUCH DAMAGES.

### Note

Some countries, states and provinces do not allow exclusions of implied warranties or conditions, so the above exclusion may not apply to you. You may have other rights that vary from country to country, state to state, or province to province. Some countries, states and provinces do not allow the exclusion or limitation of liability for incidental or consequential damages, so the above limitation may not apply to you. EXCEPT TO THE EXTENT ALLOWED BY LOCAL LAW, THESE WARRANTY TERMS DO NOT EXCLUDE, RESTRICT OR MODIFY, AND ARE IN ADDITION TO, THE MANDATORY STATUTORY RIGHTS APPLICABLE TO THE LICENSE OF ANY SOFTWARE (EMBEDDED IN THE PRODUCT) TO YOU. The United Nations Convention on Contracts for the International Sale of Goods shall not apply to any transactions regarding the sale of the Products.

## Appendix F: Compliance Information

### Installer Compliance Responsibility

Devices must be professionally installed and it is the professional installer's responsibility to make sure the device is operated within local country regulatory requirements.

### FCC

#### airFiber AF-2X

Changes or modifications not expressly approved by the party responsible for compliance could void the user's authority to operate the equipment.

This device complies with Part 15 of the FCC Rules. Operation is subject to the following two conditions.

1. This device may not cause harmful interference, and
2. This device must accept any interference received, including interference that may cause undesired operation.

This equipment has been tested and found to comply with the limits for a Class B digital device, pursuant to part 15 of the FCC Rules. These limits are designed to provide reasonable protection against harmful interference in a residential installation. This equipment generates, uses and can radiate radio frequency energy and, if not installed and used in accordance with the instructions, may cause harmful interference to radio communications. However, there is no guarantee that interference will not occur in a particular installation. If this equipment does cause harmful interference to radio or television reception, which can be determined by turning the equipment off and on, the user is encouraged to try to correct the interference by one or more of the following measures:

- Reorient or relocate the receiving antenna.
- Increase the separation between the equipment and receiver.
- Connect the equipment into an outlet on a circuit different from that to which the receiver is connected.
- Consult the dealer or an experienced radio/TV technician for help.

Operations of this equipment in a residential area is likely to cause harmful interference in which case the user will be required to correct the interference at his own expense.

This radio transmitter (FCC: SWX-AF2X) has been approved by FCC to operate with the antenna types listed below with the maximum permissible gain and required antenna impedance for each antenna type indicated. Antenna types not included in this list, having a gain greater than the maximum gain indicated for that type, are strictly prohibited for use with this device.

- Dish antenna, gain: 6 dBi
- Dish antenna, gain: 24 dBi

#### airFiber AF-3X

Changes or modifications not expressly approved by the party responsible for compliance could void the user's authority to operate the equipment.

This device complies with Part 15 of the FCC Rules. Operation is subject to the following two conditions.

1. This device may not cause harmful interference, and
2. This device must accept any interference received, including interference that may cause undesired operation.

This equipment has been tested and found to comply with the limits for a Class B digital device, pursuant to part 15 of the FCC Rules. These limits are designed to provide reasonable protection against harmful interference in a residential installation. This equipment generates, uses and can radiate radio frequency energy and, if not installed and used in accordance with the instructions, may cause harmful interference to radio communications. However, there is no guarantee that interference will not occur in a particular installation. If this equipment does cause harmful interference to radio or television reception, which can be determined by turning the equipment off and on, the user is encouraged to try to correct the interference by one or more of the following measures:

- Reorient or relocate the receiving antenna.
- Increase the separation between the equipment and receiver.
- Connect the equipment into an outlet on a circuit different from that to which the receiver is connected.
- Consult the dealer or an experienced radio/TV technician for help.

Operations of this equipment in a residential area is likely to cause harmful interference in which case the user will be required to correct the interference at his own expense.

This radio transmitter (FCC: SWX-AF3X) has been approved by FCC to operate with the antenna types listed below with the maximum permissible gain and required antenna impedance for each antenna type indicated. Antenna types not included in this list, having a gain greater than the maximum gain indicated for that type, are strictly prohibited for use with this device.

- Dish antenna, gain: 12 dBi
- Dish antenna, gain: 26 dBi
- Dish antenna, gain: 29 dBi

### airFiber AF-4X

Changes or modifications not expressly approved by the party responsible for compliance could void the user's authority to operate the equipment.

This device complies with Part 15 of the FCC Rules. Operation is subject to the following condition.

- This device may not cause harmful interference.

This equipment has been tested and found to comply with the limits for a Class B digital device, pursuant to part 15 of the FCC Rules. These limits are designed to provide reasonable protection against harmful interference in a residential installation. This equipment generates, uses and can radiate radio frequency energy and, if not installed and used in accordance with the instructions, may cause harmful interference to radio communications. However, there is no guarantee that interference will not occur in a particular installation. If this equipment does cause harmful interference to radio or television reception, which can be determined by turning the equipment off and on, the user is encouraged to try to correct the interference by one or more of the following measures:

- Reorient or relocate the receiving antenna.
- Increase the separation between the equipment and receiver.
- Connect the equipment into an outlet on a circuit different from that to which the receiver is connected.
- Consult the dealer or an experienced radio/TV technician for help.

Operations of this equipment in a residential area is likely to cause harmful interference in which case the user will be required to correct the interference at his own expense.

### airFiber AF-5X

Changes or modifications not expressly approved by the party responsible for compliance could void the user's authority to operate the equipment.

This device complies with Part 15 of the FCC Rules. Operation is subject to the following two conditions.

1. This device may not cause harmful interference, and
2. This device must accept any interference received, including interference that may cause undesired operation.

This equipment has been tested and found to comply with the limits for a Class B digital device, pursuant to part 15 of the FCC Rules. These limits are designed to provide reasonable protection against harmful interference in a residential installation. This equipment generates, uses and can radiate radio frequency energy and, if not installed and used in accordance with the instructions, may cause harmful interference to radio communications. However, there is no guarantee that interference will not occur in a particular installation. If this equipment does cause harmful interference to radio or television reception, which can be determined by turning the equipment off and on, the user is encouraged to try to correct the interference by one or more of the following measures:

- Reorient or relocate the receiving antenna.
- Increase the separation between the equipment and receiver.
- Connect the equipment into an outlet on a circuit different from that to which the receiver is connected.
- Consult the dealer or an experienced radio/TV technician for help.

Operations of this equipment in a residential area is likely to cause harmful interference in which case the user will be required to correct the interference at his own expense.

This radio transmitter (FCC: SWX-AF5X) has been approved by FCC to operate with the antenna types listed below with the maximum permissible gain and required antenna impedance for each antenna type indicated. Antenna types not included in this list, having a gain greater than the maximum gain indicated for that type, are strictly prohibited for use with this device.

- Dish antenna, gain: 23 dBi
- Dish antenna, gain: 30 dBi
- Dish antenna, gain: 34 dBi

### DFS Regulatory Regions

Operation in DFS regulatory regions requires an antenna with minimum gain of 23 dBi.

## Industry Canada

### airFiber AF-2X

#### CAN ICES-3(B)/NMB-3(B)

To reduce potential radio interference to other users, the antenna type and its gain should be so chosen that the equivalent isotropically radiated power (e.i.r.p.) is not more than that permitted for successful communication.

This device complies with Industry Canada licence-exempt RSS standard(s). Operation is subject to the following two conditions:

1. This device may not cause interference, and
2. This device must accept any interference, including interference that may cause undesired operation of the device.

This radio transmitter (IC: 6545A-AF2X) has been approved by Industry Canada to operate with the antenna types listed below with the maximum permissible gain and required antenna impedance for each antenna type indicated. Antenna types not included in this list, having a gain greater than the maximum gain indicated for that type, are strictly prohibited for use with this device.

- Dish antenna, gain: 6 dBi
- Dish antenna, gain: 24 dBi

#### CAN ICES-3(B)/NMB-3(B)

Pour réduire le risque d'interférence aux autres utilisateurs, le type d'antenne et son gain doivent être choisis de façon que la puissance isotrope rayonnée équivalente (PIRE) ne dépasse pas ce qui est nécessaire pour une communication réussie.

Cet appareil est conforme à la norme RSS Industrie Canada exempts de licence norme(s). Son fonctionnement est soumis aux deux conditions suivantes:

1. Cet appareil ne peut pas provoquer d'interférences et
2. Cet appareil doit accepter toute interférence, y compris les interférences qui peuvent causer un mauvais fonctionnement du dispositif.

Cet émetteur radio (IC: 6545A-AF2X) a été approuvée par Industrie Canada pour l'exploitation avec l'antenne types énumérés ci-dessous avec le gain maximal admissible et requis l'impédance de l'antenne pour chaque type d'antenne indiqué. Types d'antenne non inclus dans cette liste, ayant un gain supérieur au gain maximal indiqué pour ce type, sont strictement interdits pour une utilisation avec cet appareil. Immédiatement suite à la remarque, le fabricant doit fournir une liste de tous les types d'antenne approuvé pour une utilisation avec l'émetteur, ce qui indique le gain maximal d'antenne permis (en dBi) et requis d'impédance pour chacun.

- Antenne parabolique, gain: 6 dBi
- Antenne parabolique, gain: 24 dBi

### airFiber AF-3X

#### CAN ICES-3(B)/NMB-3(B)

To reduce potential radio interference to other users, the antenna type and its gain should be so chosen that the equivalent isotropically radiated power (e.i.r.p.) is not more than that permitted for successful communication.

This device complies with Industry Canada licence-exempt RSS standard(s). Operation is subject to the following two conditions:

1. This device may not cause interference, and
2. This device must accept any interference, including interference that may cause undesired operation of the device.

This radio transmitter (IC: 6545A-AF3X) has been approved by Industry Canada to operate with the antenna types listed below with the maximum permissible gain and required antenna impedance for each antenna type indicated. Antenna types not included in this list, having a gain greater than the maximum gain indicated for that type, are strictly prohibited for use with this device.

- Dish antenna, gain: 12 dBi
- Dish antenna, gain: 26 dBi
- Dish antenna, gain: 29 dBi

#### CAN ICES-3(B)/NMB-3(B)

Pour réduire le risque d'interférence aux autres utilisateurs, le type d'antenne et son gain doivent être choisis de façon que la puissance isotrope rayonnée équivalente (PIRE) ne dépasse pas ce qui est nécessaire pour une communication réussie.

Cet appareil est conforme à la norme RSS Industrie Canada exempts de licence norme(s). Son fonctionnement est soumis aux deux conditions suivantes:

1. Cet appareil ne peut pas provoquer d'interférences et
2. Cet appareil doit accepter toute interférence, y compris les interférences qui peuvent causer un mauvais fonctionnement du dispositif.

Cet émetteur radio (IC: 6545A-AF3X) a été approuvée par Industrie Canada pour l'exploitation avec l'antenne types énumérés ci-dessous avec le gain maximal admissible et requis l'impédance de l'antenne pour chaque type d'antenne indiqué. Types d'antenne non inclus dans cette liste, ayant un gain supérieur au gain maximal indiqué pour ce type, sont strictement interdits pour une utilisation avec cet appareil. Immédiatement suite à la remarque, le fabricant doit fournir une liste de tous les types d'antenne approuvé pour une utilisation avec l'émetteur, ce qui indique le gain maximal d'antenne permis (en dBi) et requis d'impédance pour chacun.

- Antenne parabolique, gain: 12 dBi
- Antenne parabolique, gain: 26 dBi
- Antenne parabolique, gain: 29 dBi



## airFiber AF-4X

### CAN ICES-3(B)/NMB-3(B)

To reduce potential radio interference to other users, the antenna type and its gain should be so chosen that the equivalent isotropically radiated power (e.i.r.p.) is not more than that permitted for successful communication.

This device complies with Industry Canada licence-exempt RSS standard(s). Operation is subject to the following condition:

- This device may not cause interference.

### CAN ICES-3(B)/NMB-3(B)

Pour réduire le risque d'interférence aux autres utilisateurs, le type d'antenne et son gain doivent être choisis de façon que la puissance isotrope rayonnée équivalente (PIRE) ne dépasse pas ce qui est nécessaire pour une communication réussie.

Cet appareil est conforme à la norme RSS Industrie Canada exempts de licence norme(s). Son fonctionnement est soumis à la condition suivante:

- Cet appareil ne peut pas provoquer d'interférences.

## airFiber AF-5X

### CAN ICES-3(B)/NMB-3(B)

To reduce potential radio interference to other users, the antenna type and its gain should be so chosen that the equivalent isotropically radiated power (e.i.r.p.) is not more than that permitted for successful communication.

This device complies with Industry Canada licence-exempt RSS standard(s). Operation is subject to the following two conditions:

1. This device may not cause interference, and
2. This device must accept any interference, including interference that may cause undesired operation of the device.

This radio transmitter (IC: 6545A-AF5X) has been approved by Industry Canada to operate with the antenna types listed below with the maximum permissible gain and required antenna impedance for each antenna type indicated. Antenna types not included in this list, having a gain greater than the maximum gain indicated for that type, are strictly prohibited for use with this device.

- Dish antenna, gain: 23 dBi
- Dish antenna, gain: 30 dBi
- Dish antenna, gain: 34 dBi

### CAN ICES-3(B)/NMB-3(B)

Pour réduire le risque d'interférence aux autres utilisateurs, le type d'antenne et son gain doivent être choisis de façon que la puissance isotrope rayonnée équivalente (PIRE) ne dépasse pas ce qui est nécessaire pour une communication réussie.

Cet appareil est conforme à la norme RSS Industrie Canada exempts de licence norme(s). Son fonctionnement est soumis aux deux conditions suivantes:

1. Cet appareil ne peut pas provoquer d'interférences et
2. Cet appareil doit accepter toute interférence, y compris les interférences qui peuvent causer un mauvais fonctionnement du dispositif.

Cet émetteur radio (IC: 6545A-AF5X) a été approuvée par Industrie Canada pour l'exploitation avec l'antenne types énumérés ci-dessous avec le gain maximal admissible et requis l'impédance de l'antenne pour chaque type d'antenne indiqué. Types d'antenne non inclus dans cette liste, ayant un gain supérieur au gain maximal indiqué pour ce type, sont strictement interdits pour une utilisation avec cet appareil. Immédiatement suite à la remarque, le fabricant doit fournir une liste de tous les types d'antenne approuvée pour une utilisation avec l'émetteur, ce qui indique le gain maximal d'antenne permis (en dBi) et requis d'impédance pour chacun.

- Antenne parabolique, gain: 23 dBi
- Antenne parabolique, gain: 30 dBi
- Antenne parabolique, gain: 34 dBi



## RF Exposure Warning

### airFiber AF-2X

The antennas used for this transmitter must be installed to provide a separation distance of at least 126 cm from all persons and must not be located or operating in conjunction with any other antenna or transmitter.

Les antennes utilisées pour ce transmetteur doivent être installé en considérant une distance de séparation de toute personnes d'au moins 126 cm et ne doivent pas être localisé ou utilisé en conflit avec tout autre antenne ou transmetteur.

### airFiber AF-3X

The antennas used for this transmitter must be installed to provide a separation distance of at least 364 cm from all persons and must not be located or operating in conjunction with any other antenna or transmitter.

Les antennes utilisées pour ce transmetteur doivent être installé en considérant une distance de séparation de toute personnes d'au moins 364 cm et ne doivent pas être localisé ou utilisé en conflit avec tout autre antenne ou transmetteur.

### airFiber AF-4X

The radiated output power of this device is below the FCC radio frequency exposure limits. Nevertheless, the device should be used in such a manner that the potential for human contact during the normal operation is minimized. In order to avoid the possibility of exceeding the FCC radio frequency exposure limit, human proximity to the antenna should be more than 180 cm.

La puissance de sortie rayonnée de cet appareil est inférieure aux limites d'exposition de radio de fréquence FCC. Néanmoins, le dispositif doit être utilisé de telle manière que le potentiel pour le contact humain pendant l'utilisation normale soit minimisé. Afin d'éviter la possibilité de dépasser la limite d'exposition de fréquence radio de la FCC, la proximité humaine à l'antenne devrait être plus que 180 cm.

### airFiber AF-5X

The antennas used for this transmitter must be installed to provide a separation distance of at least 126 cm from all persons and must not be located or operating in conjunction with any other antenna or transmitter.

Les antennes utilisées pour ce transmetteur doivent être installé en considérant une distance de séparation de toute personnes d'au moins 126 cm et ne doivent pas être localisé ou utilisé en conflit avec tout autre antenne ou transmetteur.

## Australia and New Zealand

### airFiber AF-2X



Warning: This is a Class B product. In a domestic environment this product may cause radio interference in which case the user may be required to take adequate measures.

### airFiber AF-3X



Warning: This is a Class B product. In a domestic environment this product may cause radio interference in which case the user may be required to take adequate measures.

### airFiber AF-4X



Warning: This is a Class B product. In a domestic environment this product may cause radio interference in which case the user may be required to take adequate measures.

### airFiber AF-5X



Warning: This is a Class B product. In a domestic environment this product may cause radio interference in which case the user may be required to take adequate measures.

## CE Marking

### airFiber AF-2X

CE marking on this product represents the product is in compliance with all directives that are applicable to it.



### airFiber AF-3X

CE marking on this product represents the product is in compliance with all directives that are applicable to it.



### airFiber AF-4X

CE marking on this product represents the product is in compliance with all directives that are applicable to it.



### airFiber AF-5X

CE marking on this product represents the product is in compliance with all directives that are applicable to it.

### Alert sign! follows CE marking

Alert sign must be indicated if a restriction on use applied to the product and it must follow the CE marking.



## airFiber AF-4X Compliance

The user is responsible for obtaining all licenses that are required by the local country in which the product will be operated, and all such licenses must be obtained prior to operation in the particular country. For information on licenses required by your country as well as conditions of use for the 4 GHz band, contact your appropriate national authority.

### 4.9 GHz Band Devices (FCC and Industry Canada)

The 4.9 GHz band is a licensed band allocated to public safety services. State and local government entities that provide public safety services are eligible to apply for 4.9 GHz licenses. For additional information, refer to FCC or Industry Canada regulations.

## Frequency Ranges and Power Levels per Country/Region

### airFiber AF-2X

The product can be operated in the countries and regions listed in the following table, within the stated frequency ranges and output power (EIRP) limits.

Each country has its own power level and frequency regulations. To ensure the product operates under the necessary regulatory compliance rules, the country where the device will be used must be selected during installation. The frequency settings and output power (EIRP) limits will be tuned according to the regulations of the selected country/region:

Country/Region	Frequency Range (Band Edges in MHz)	Max. EIRP (dBm)
Argentina	2400-2483	36
Australia	2400-2483	36
Bahrain	2400-2483	36
Brazil	2400-2483	36
Canada	2400-2483	36*
Chile	2400-2483	36
China	2400-2483	36
Colombia	2400-2483	36
Ecuador	2400-2483	36
Ghana	2400-2483	36
Guam (U.S. territory)	2400-2483	36*
Hong Kong	2400-2483	36
Indonesia	2400-2483	36
India	2400-2483	36
Kenya	2400-2483	36
Korea Republic	2400-2483	36
Kyrgyzstan	2400-2483	Not applicable
Malaysia	2400-2483	36
Mexico	2400-2483	36
New Zealand	2400-2483	36
Nigeria	2400-2483	36
Peru	2400-2483	36
Philippines	2400-2483	36
Puerto Rico (U.S. territory)	2400-2483	36*
Singapore	2400-2483	36
South Africa	2400-2483	36
Taiwan	2400-2483	36
Tajikistan	2400-2483	Not applicable
Thailand	2400-2483	20
Turkmenistan	2400-2483	Not applicable
Uganda	2400-2483	Not applicable
United States	2400-2483	36*
Uzbekistan	2400-2483	Not applicable
Venezuela	2400-2483	36
Virgin Islands (U.S. territory)	2400-2483	36*
Vietnam	2400-2483	36

\* A higher EIRP is possible based on FCC Part 15 requirements of reduction of conducted power by 1 dBm per 3 dBi increase of antenna gain beyond 6 dBi.

**airFiber AF-3X**

The product can be operated in the countries and regions listed in the following table, within the stated frequency ranges and output power (EIRP) limits.

Each country has its own power level and frequency regulations. To ensure the product operates under the necessary regulatory compliance rules, the country where the device will be used must be selected during installation. The frequency settings and output power (EIRP) limits will be tuned according to the regulations of the selected country/region:

Country/Region	Frequency Range (Band Edges in MHz)	Max. EIRP (dBm)
Austria	3410-3900	66
Belgium	3410-3900	66
Bulgaria	3410-3900	66
Canada	3450-3650 3650-3700	57 44
Croatia	3410-3900	66
Cyprus	3410-3900	66
Czech Republic	3410-3900	66
Denmark	3410-3900	66
Estonia	3410-3900	66
Finland	3410-3900	66
France	3410-3900	66
Germany	3410-3900	66
Greece	3410-3900	66
Guam (U.S. territory)	3650-3700	44
Hungary	3410-3900	66
Ireland	3410-3900	66
Italy	3410-3900	66
Latvia	3410-3900	66
Lithuania	3410-3900	66
Malta	3410-3900	66
Netherlands	3410-3900	66
Poland	3410-3900	66
Portugal	3410-3900	66
Puerto Rico (U.S. territory)	3650-3700	44
Romania	3410-3900	66
Slovakia	3410-3900	66
Spain	3410-3900	66
Sweden	3410-3900	66
United Kingdom	3410-3900	66
United States	3650-3700	44
Virgin Islands (U.S. territory)	3650-3700	44

**airFiber AF-4X**

The product can be operated in the countries and regions listed in the following table, within the stated frequency ranges and output power (EIRP) limits.

Users are responsible to comply with all local regulatory rules and requirements beyond what is stated in the table.

Each country has its own power level and frequency regulations. To ensure the product operates under the necessary regulatory compliance rules, the country where the device will be used must be selected during installation. The frequency settings and output power (EIRP) limits will be tuned according to the regulations of the selected country/region:

Country/Region	Frequency Range (Band Edges in MHz)	Max. EIRP (dBm)
Austria	3410-3900	55
Belgium	3410-3900	55
Bulgaria	3410-3900	55
Canada	4940-4990	55
Croatia	3410-3900	55
Cyprus	3410-3900	55
Czech Republic	3410-3900	55
Denmark	3410-3900	55
Estonia	3410-3900	55
Finland	3410-3900	55
France	3410-3900	55
Germany	3410-3900	55
Greece	3410-3900	55
Guam (U.S. territory)	4940-4990	55
Hungary	3410-3900	55
Ireland	3410-3900	55
Italy	3410-3900	55
Latvia	3410-3900	55
Lithuania	3410-3900	55
Malta	3410-3900	55
Netherlands	3410-3900	55
Poland	3410-3900	55
Portugal	3410-3900	55
Puerto Rico (U.S. territory)	4940-4990	55
Romania	3410-3900	55
Slovakia	3410-3900	55
Spain	3410-3900	55
Sweden	3410-3900	55
United Kingdom	3410-3900	55
United States	4940-4990	55
Virgin Islands (U.S. territory)	4940-4990	55

## airFiber AF-5X

The product can be operated in the countries and regions listed in the following table, within the stated frequency ranges and output power (EIRP) limits.

Each country has its own power level and frequency regulations. To ensure the product operates under the necessary regulatory compliance rules, the country where the device will be used must be selected during installation. The frequency settings and output power (EIRP) limits will be tuned according to the regulations of the selected country/region:

Country/Region	5.1 GHz		5.2 GHz		5.4 GHz		5.8 GHz	
	Frequency Range (Band Edges in MHz)	Max. EIRP (dBm)	Frequency Range (Band Edges in MHz)	Max. EIRP (dBm)	Frequency Range (Band Edges in MHz)	Max. EIRP (dBm)	Frequency Range (Band Edges in MHz)	Max. EIRP (dBm)
Argentina	5150-5250	49			5470-5725	30	5725-5850	36
Australia					5470-5600, 5650-5725	30	5725-5855	36
Bahrain							5735-5835	20
Barbados							5725-5850	36
Belize							5735-5835	30
Bolivia							5735-5835	30
Brazil					5470-5725	30	5725-5850	53
Brunei Darussalam							5735-5835	20
Canada			5250-5350	30	5470-5600, 5650-5725	30	5725-5850	60
Chile			5250-5350	30			5735-5835	20
China							5735-5835	30
Colombia			5250-5350	30			5735-5835	30
Costa Rica							5735-5835	30
Denmark					5470-5725	30	5725-5795, 5815-5850	36
Dominican Republic							5735-5835	30
Ecuador	5150-5250	49	5250-5350	30			5735-5835	30
El Salvador							5735-5835	30
Finland					5470-5725	30	5725-5795, 5815-5850	36
Germany					5470-5725	30	5755-5875	36
Greece					5470-5725	30	5725-5795	36
Grenada					5470-5725	30	5725-5850	36
Guatemala							5735-5835	30
Honduras					5470-5725	30	5725-5850	36
Hong Kong			5250-5350	30	5470-5725	30	5725-5850	36
Iceland					5470-5725	30	5725-5875	36
India							5825-5875	36
Iraq							5735-5835	36
Ireland					5470-5725	30	5725-5875	33
Italy					5470-5725	30		
Jamaica					5470-5725	30	5725-5850	36



Country/Region	5.1 GHz		5.2 GHz		5.4 GHz		5.8 GHz	
	Frequency Range (Band Edges in MHz)	Max. EIRP (dBm)	Frequency Range (Band Edges in MHz)	Max. EIRP (dBm)	Frequency Range (Band Edges in MHz)	Max. EIRP (dBm)	Frequency Range (Band Edges in MHz)	Max. EIRP (dBm)
Kenya			5250-5350	30			5735-5835	30
Korea Republic					5490-5710	30	5735-5815	30
Lebanon							5735-5835	30
Liechtenstein					5470-5725	30	5725-5795, 5815-5875	36
Macau							5725-5850	36
Malaysia	5150-5250	49	5250-5350	30			5735-5835	30
Mexico							5735-5835	30
Morocco							5735-5835	20
Nepal							5735-5835	30
New Zealand					5470-5725	30	5725-5850	53
Norway					5470-5725	30	5725-5795, 5815-5850	53
Oman					5470-5725	30	5725-5850	36
Pakistan							5735-5835	30
Panama							5735-5835	30
Papua New Guinea							5735-5835	30
Peru	5150-5250	49	5250-5350	30	5470-5725	30	5725-5850	36
Philippines	5150-5250	49	5250-5350	30	5470-5725	30	5725-5850	36
Portugal					5470-5725	30	5725-5875	36
Puerto Rico (U.S. territory)			5250-5350	30	5470-5600, 5650-5725	30	5725-5850	60
Qatar							5735-5835	30
Russia	5150-5350	43			5470-5650	23	5650-5950	53
Singapore							5735-5835	30
South Africa					5470-5725	30	5725-5850	60
Spain					5470-5725	30	5725-5795, 5815-5855	36
Switzerland					5470-5725	30	5725-5795, 5815-5855	36
Taiwan			5250-5350	30	5490-5710	30	5735-5815	30
Thailand			5250-5350	30	5470-5725	30	5725-5850	36
Trinidad And Tobago					5470-5725	30	5725-5850	36
United Kingdom					5470-5725	30	5725-5790, 5815-5850	36
United States	5150-5250	49	5250-5350	30	5470-5600, 5650-5725	30	5725-5850	60
Uruguay					5470-5725	30	5725-5850	36
Uzbekistan					5470-5725	30	5725-5850	36
Venezuela	5150-5250	49	5250-5350	30			5735-5835	30

The following table lists the maximum transmit output power (EIRP) for the 5.1 GHz band.

5.1 GHz Band		Maximum Transmit Output Power (EIRP) in dBm
Channel Bandwidth	Frequency Range (Band Edges in MHz)	
10 MHz	5155-5175	39
	5166-5186	44
	5177-5250	49
20 MHz	5156-5180	37
	5161-5185	39
	5166-5209	44
30 MHz	5190-5250	49
	5155-5192	37
	5163-5202	39
	5173-5211	44
40 MHz	5182-5250	49
	5155-5204	37
	5165-5219	39
	5180-5228	44
50 MHz	5189-5250	49
	5155-5214	37
	5165-5233	39
	5184-5242	44
	5193-5250	49

## RoHS/WEEE Compliance Statement



### English

European Directive 2012/19/EU requires that the equipment bearing this symbol on the product and/or its packaging must not be disposed of with unsorted municipal waste. The symbol indicates that this product should be disposed of separately from regular household waste streams. It is your responsibility to dispose of this and other electric and electronic equipment via designated collection facilities appointed by the government or local authorities. Correct disposal and recycling will help prevent potential negative consequences to the environment and human health. For more detailed information about the disposal of your old equipment, please contact your local authorities, waste disposal service, or the shop where you purchased the product.

### Deutsch

Die Europäische Richtlinie 2012/19/EU verlangt, dass technische Ausrüstung, die direkt am Gerät und/oder an der Verpackung mit diesem Symbol versehen ist, nicht zusammen mit unsortiertem Gemeindeabfall entsorgt werden darf. Das Symbol weist darauf hin, dass das Produkt von regulärem Haushaltsmüll getrennt entsorgt werden sollte. Es liegt in Ihrer Verantwortung, dieses Gerät und andere elektrische und elektronische Geräte über die dafür zuständigen und von der Regierung oder örtlichen Behörden dazu bestimmten Sammelstellen zu entsorgen. Ordnungsgemäßes Entsorgen und Recyceln trägt dazu bei, potentielle negative Folgen für Umwelt und die menschliche Gesundheit zu vermeiden. Wenn Sie weitere Informationen zur Entsorgung Ihrer Altgeräte benötigen, wenden Sie sich bitte an die örtlichen Behörden oder städtischen Entsorgungsdienste oder an den Händler, bei dem Sie das Produkt erworben haben.

### Español

La Directiva 2012/19/UE exige que los equipos que lleven este símbolo en el propio aparato y/o en su embalaje no deben eliminarse junto con otros residuos urbanos no seleccionados. El símbolo indica que el producto en cuestión debe separarse de los residuos domésticos convencionales con vistas a su eliminación. Es responsabilidad suya desechar este y cualesquiera otros aparatos eléctricos y electrónicos a través de los puntos de recogida que ponen a su disposición el gobierno y las autoridades locales. Al desechar y reciclar correctamente estos aparatos estará contribuyendo a evitar posibles consecuencias negativas para el medio ambiente y la salud de las personas. Si desea obtener información más detallada sobre la eliminación segura de su aparato usado, consulte a las autoridades locales, al servicio de recogida y eliminación de residuos de su zona o pregunte en la tienda donde adquirió el producto.

### Français

La directive européenne 2012/19/UE exige que l'équipement sur lequel est apposé ce symbole sur le produit et/ou son emballage ne soit pas jeté avec les autres ordures ménagères. Ce symbole indique que le produit doit être éliminé dans un circuit distinct de celui pour les déchets des ménages. Il est de votre responsabilité de jeter ce matériel ainsi que tout autre matériel électrique ou électronique par les moyens de collecte indiqués par le gouvernement et les pouvoirs publics des collectivités territoriales. L'élimination et le recyclage en bonne et due forme ont pour but de lutter contre l'impact néfaste potentiel de ce type de produits sur l'environnement et la santé publique. Pour plus d'informations sur le mode d'élimination de votre ancien équipement, veuillez prendre contact avec les pouvoirs publics locaux, le service de traitement des déchets, ou l'endroit où vous avez acheté le produit.

### Italiano

La direttiva europea 2012/19/UE richiede che le apparecchiature contrassegnate con questo simbolo sul prodotto e/o sull'imballaggio non siano smaltite insieme ai rifiuti urbani non differenziati. Il simbolo indica che questo prodotto non deve essere smaltito insieme ai normali rifiuti domestici. È responsabilità del proprietario smaltire sia questi prodotti sia le altre apparecchiature elettriche ed elettroniche mediante le specifiche strutture di raccolta indicate dal governo o dagli enti pubblici locali. Il corretto smaltimento ed il riciclaggio aiuteranno a prevenire conseguenze potenzialmente negative per l'ambiente e per la salute dell'essere umano. Per ricevere informazioni più dettagliate circa lo smaltimento delle vecchie apparecchiature in Vostro possesso, Vi invitiamo a contattare gli enti pubblici di competenza, il servizio di smaltimento rifiuti o il negozio nel quale avete acquistato il prodotto.



# Appendix G: Declaration of Conformity

<b>Česky</b> [Czech]	UBIQUITI NETWORKS tímto prohlašuje, že toto UBIQUITI NETWORKS zařízení, je ve shod se základními požadavky a dalšími příslušnými ustanoveními směrnice 1999/5/ES.	<b>Română</b> [Romanian]	Prin prezenta, UBIQUITI NETWORKS declară că acest dispozitiv UBIQUITI NETWORKS este în conformitate cu cerințele esențiale și alte prevederi relevante ale Directivei 1999/5/CE.
<b>Dansk</b> [Danish]	Hermed, UBIQUITI NETWORKS, erklærer at denne UBIQUITI NETWORKS enhed, er i overensstemmelse med de væsentlige krav og øvrige relevante krav i direktiv 1999/5/EF.	<b>Slovensky</b> [Slovak]	Týmto UBIQUITI NETWORKS, prehlasuje, že toto UBIQUITI NETWORKS zariadenie, je v súlade so základnými požiadavkami a ďalšími relevantnými ustanoveniami smernice 1999/5/ES.
<b>Nederlands</b> [Dutch]	Hierbij verklaart UBIQUITI NETWORKS, dat deze UBIQUITI NETWORKS apparaat, in overeenstemming is met de essentiële eisen en de andere relevante bepalingen van richtlijn 1999/5/EG.	<b>Español</b> [Spanish]	Por medio de la presente UBIQUITI NETWORKS declara que este dispositivo UBIQUITI NETWORKS, cumple con los requisitos esenciales y cualesquiera otras disposiciones aplicables o exigibles de la Directiva 1999/5/CE.
<b>English</b>	Hereby, UBIQUITI NETWORKS, declares that this UBIQUITI NETWORKS device, is in compliance with the essential requirements and other relevant provisions of Directive 1999/5/EC.	<b>Svenska</b> [Swedish]	Härmed UBIQUITI NETWORKS, intygar att denna UBIQUITI NETWORKS enhet är i överensstämmelse med de väsentliga egenskapskrav och övriga relevanta bestämmelser som framgår av direktiv 1999/5/EG.
<b>Eesti</b> [Estonian]	Käesolevaga UBIQUITI NETWORKS kinnitab, et antud UBIQUITI NETWORKS seade, on vastavus oluliste nõuetele ja teiste asjakohastele sätetele direktiivi 1999/5/EÜ.		
<b>Suomi</b> [Finnish]	Täten UBIQUITI NETWORKS vakuuttaa, että tämä UBIQUITI NETWORKS laite, on yhdenmukainen olennaisten vaatimusten ja muiden sitä koskevien direktiivin 1999/5/EY.		
<b>Français</b> [French]	Par la présente UBIQUITI NETWORKS déclare que l'appareil UBIQUITI NETWORKS, est conforme aux exigences essentielles et aux autres dispositions pertinentes de la directive 1999/5/CE.		
<b>Deutsch</b> [German]	Hiermit erklärt UBIQUITI NETWORKS, dass sich dieses UBIQUITI NETWORKS Gerät, in Übereinstimmung mit den grundlegenden Anforderungen und den anderen relevanten Vorschriften der Richtlinie 1999/5/EG befindet.		
<b>Ελληνική</b> [Greek]	Δια του παρόντος, UBIQUITI NETWORKS, δηλώνει ότι αυτή η συσκευή UBIQUITI NETWORKS, είναι σε συμμόρφωση με τις βασικές απαιτήσεις και τις λοιπές σχετικές διατάξεις της οδηγίας 1995/5/EK.		
<b>Magyar</b> [Hungarian]	Ezennel UBIQUITI NETWORKS kijelenti, hogy ez a UBIQUITI NETWORKS készülék megfelel az alapvető követelményeknek és más vonatkozó 1999/5/EK irányelv rendelkezéseit.		
<b>Íslenska</b> [Icelandic]	Hér, UBIQUITI NETWORKS, því yfir að þetta UBIQUITI NETWORKS tæki er í samræmi við grunnkröfur og önnur viðeigandi ákvæði tilskipun 1999/5/EB.		
<b>Italiano</b> [Italian]	Con la presente, UBIQUITI NETWORKS, dichiara che questo dispositivo UBIQUITI NETWORKS, è conforme ai requisiti essenziali ed alle altre disposizioni pertinenti della direttiva 1999/5/CE.		
<b>Latviski</b> [Latvian]	Ar šo, UBIQUITI NETWORKS, deklarē, ka UBIQUITI NETWORKS ierīce, ir saskaņā ar būtiskajām prasībām un citiem attiecīgiem noteikumiem Direktīvā 1999/5/EK.		
<b>Lietuviškai</b> [Lithuanian]	UBIQUITI NETWORKS deklaruoja, kad šis UBIQUITI NETWORKS įrenginys atitinka esminius reikalavimus ir kitas 1999/5/EB Direktyvos nuostatas.		
<b>Malti</b> [Maltese]	Hawnhekk, UBIQUITI NETWORKS, tiddikjara li dan il-mezz UBIQUITI NETWORKS huwa konformi mar-rekwiżiti essenzjali u dispozizzjonijiet rilevanti oħrajn ta' Direttiva 1999/5/KE.		
<b>Norsk</b> [Norwegian]	Herved UBIQUITI NETWORKS, erklærer at denne UBIQUITI NETWORKS enheten, er i samsvar med de grunnleggende kravene og andre relevante bestemmelser i direktiv 1999/5/EF.		
<b>Polski</b> [Polish]	Niniejszym, Ubiquiti Networks, oświadczam, że urządzenie UBIQUITI NETWORKS, jest zgodny z zasadniczymi wymaganiami oraz pozostałymi stosownymi postanowieniami Dyrektywy 1999/5/WE.		
<b>Português</b> [Portuguese]	UBIQUITI NETWORKS declara que este dispositivo UBIQUITI NETWORKS, está conforme com os requisitos essenciais e outras disposições da Directiva 1999/5/CE.		





## Appendix H: Contact Information

---

### Ubiquiti Networks Support

Ubiquiti Support Engineers are located around the world and are dedicated to helping customers resolve software, hardware compatibility, or field issues as quickly as possible. We strive to respond to support inquiries within a 24-hour period.

Ubiquiti Networks, Inc.  
2580 Orchard Parkway  
San Jose, CA 95131  
[www.ubnt.com](http://www.ubnt.com)

### Online Resources

Support: [ubnt.link/airFiber-Support](http://ubnt.link/airFiber-Support)

Community: [community.ubnt.com/airfiber](http://community.ubnt.com/airfiber)

Downloads: [downloads.ubnt.com/airfiber](http://downloads.ubnt.com/airfiber)



[www.ubnt.com](http://www.ubnt.com)