



# User Guide

AXE5400 Tri-Band Wi-Fi 6E Router  
Archer AXE75

# Contents

About This Guide .....	1
<b>Chapter 1. Get to Know About Your Router .....</b>	<b>3</b>
1. 1. Product Overview.....	4
1. 2. Appearance .....	4
1. 2. 1.Top Panel .....	4
1. 2. 2.Back Panel .....	5
1. 2. 3.Side Panel.....	6
<b>Chapter 2. Connect the Hardware .....</b>	<b>7</b>
2. 1. Position Your Router .....	8
2. 2. Connect Your Router.....	8
<b>Chapter 3. Log In to Your Router.....</b>	<b>11</b>
<b>Chapter 4. Set Up Internet Connection .....</b>	<b>13</b>
4. 1. Use Quick Setup Wizard .....	14
4. 2. Quick Setup Via TP-Link Tether App.....	14
4. 3. Manually Set Up Your Internet Connection .....	15
4. 4. Set Up the Router as an Access Point .....	18
4. 5. Set Up an IPv6 Internet Connection .....	18
<b>Chapter 5. TP-Link Cloud Service .....</b>	<b>22</b>
5. 1. Register a TP-Link ID.....	23
5. 2. Change Your TP-Link ID Information.....	23
5. 3. Manage the User TP-Link IDs .....	24
5. 3. 1.Add TP-Link ID to Manage the Router .....	25
5. 3. 2.Remove TP-Link ID(s) from Managing the Router .....	25
5. 4. Manage the Router via the TP-Link Tether App .....	26
<b>Chapter 6. Wireless Settings .....</b>	<b>27</b>
6. 1. Specify Wireless Settings .....	28
6. 2. Schedule Your Wireless Function .....	30
6. 3. Use WPS for Wireless Connection .....	31
6. 3. 1.Connect via the Client's PIN .....	31

6. 3. 2.Connect via the Router's PIN .....	32
6. 3. 3.Push the WPS Button.....	32
6. 4. Advanced Wireless Settings .....	33
<b>Chapter 7. Guest Network.....</b>	<b>35</b>
7. 1. Create a Network for Guests .....	36
7. 2. Customize Guest Network Options.....	37
<b>Chapter 8. USB Settings.....</b>	<b>38</b>
8. 1. Access the USB Storage Device .....	39
8. 1. 1.Access the USB Device Locally.....	39
8. 1. 2.Access the USB Device Remotely .....	40
8. 1. 3.Customize the Access Settings.....	42
8. 2. Media Sharing .....	44
8. 3. Time Machine .....	45
<b>Chapter 9. HomeShield .....</b>	<b>47</b>
9. 1. Network Security .....	48
9. 2. Parental Controls .....	48
9. 3. Network Analysis & Optimization.....	49
<b>Chapter 10.OneMesh with Seamless Roaming .....</b>	<b>51</b>
10. 1. Set Up a OneMesh Network.....	52
10. 2. Manage Devices in the OneMesh Network .....	54
<b>Chapter 11.Network Security .....</b>	<b>56</b>
11. 1. Protect the Network from Cyber Attacks .....	57
11. 2. Access Control .....	57
11. 3. IP & MAC Binding .....	59
11. 4. ALG .....	61
<b>Chapter 12.NAT Forwarding.....</b>	<b>62</b>
12. 1. Share Local Resources on the Internet by Port Forwarding .....	63
12. 2. Open Ports Dynamically by Port Triggering.....	65
12. 3. Make Applications Free from Port Restriction by DMZ .....	66
12. 4. Make Xbox Online Games Run Smoothly by UPnP .....	67
<b>Chapter 13.VPN Server&amp;Client.....</b>	<b>69</b>
13. 1. Use OpenVPN to Access Your Home Network.....	70

13. 2.	Use PPTP VPN to Access Your Home Network .....	71
13. 3.	Use L2TP/IPSec VPN to Access Your Home Network .....	76
13. 4.	Use VPN Client to Access a Remote VPN Server .....	83

## **Chapter 14. Customize Your Network Settings..... 88**

14. 1.	Change the LAN Settings .....	89
14. 2.	Configure to Support IPTV Service.....	89
14. 3.	Specify DHCP Server Settings .....	91
14. 4.	Set Up a Dynamic DNS Service Account .....	92
14. 5.	Create Static Routes.....	93

## **Chapter 15. Manage the Router ..... 96**

15. 1.	Update the Firmware.....	97
15. 1. 1.	Auto Update .....	97
15. 1. 2.	Online Update .....	97
15. 1. 3.	Local Update .....	98
15. 2.	Backup and Restore Configuration Settings .....	99
15. 3.	Change the Login Password .....	100
15. 4.	Password Recovery .....	101
15. 5.	Local Management .....	102
15. 6.	Remote Management.....	103
15. 7.	System Log.....	105
15. 8.	Test the Network Connectivity .....	107
15. 9.	Set System Time and Language .....	109
15. 10.	Set the Router to Reboot Regularly.....	111
15. 11.	Control the LED.....	112

## **FAQ..... 113**







# About This Guide

This guide is a complement of Quick Installation Guide. The Quick Installation Guide instructs you on quick internet setup, and this guide provides details of each function and shows you the way to configure these functions appropriate to your needs.

Note: Features available in the router may vary by model and software version. Router availability may also vary by region or ISP. All images, steps, and descriptions in this guide are only examples and may not reflect your actual Router experience.

## Conventions

In this guide the following conventions are used:

Convention	Description
<u>Underlined</u>	Underlined words or phrases are hyperlinks. You can click to redirect to a website or a specific section.
Teal	Contents to be emphasized and texts on the web page are in teal, including the menus, items, buttons, etc.
>	The menu structures to show the path to load the corresponding page. For example, <b>Advanced</b> > <b>System</b> > <b>Firmware Update</b> means the Firmware Update page is under the System menu that is located in the Advanced tab.
 <b>Note:</b>	Ignoring this type of note might result in a malfunction or damage to the device.
 <b>Tips:</b>	Indicates important information that helps you make better use of your device.
symbols on the web page	<ul style="list-style-type: none"><li> Click to edit the corresponding entry.</li><li> Click to delete the corresponding entry.</li><li> click to enable or disable the corresponding entry.</li><li> Click to view more information about items on the page.</li></ul>

## More Info

The latest software, management app and utility can be found at [Download Center](https://www.tp-link.com/support/download) at <https://www.tp-link.com/support/download>.

The Quick Installation Guide can be found where you find this guide or inside the package of the router.

Specifications can be found on the product page at <https://www.tp-link.com>.

TP-Link Community is provided for you to discuss our products and share knowledge at <https://community.tp-link.com>.

Our Technical Support contact information can be found at the [Contact Technical Support](https://www.tp-link.com/support) page at <https://www.tp-link.com/support>.

- \* Maximum wireless signal rates are the physical rates derived from IEEE Standard 802.11 specifications. Actual wireless data throughput and wireless coverage are not guaranteed and will vary as a result of 1) environmental factors, including building materials, physical objects, and obstacles, 2) network conditions, including local interference, volume and density of traffic, product location, network complexity, and network overhead, and 3) client limitations, including rated performance, location, connection, quality, and client condition.
- \* Use of Wi-Fi 6 (802.11ax), Wi-Fi 6E, and features including OFDMA, 1024-QAM, and HE160 require clients to also support the corresponding features. Seven 160MHz channels may not be all available in the 6 GHz band in some regions/countries due to regulatory restrictions.
- \* Saving clients' battery power requires clients to also support the 802.11ax Wi-Fi standard. Actual power reduction may vary as a result of network conditions, client limitations, and environmental factors.
- \* HomeShield includes the Free Basic Plan. Fees apply for the Pro Plan. Visit [tp-link.com/homeshield](https://tp-link.com/homeshield) for more information.
- \* Use of WPA3 requires clients to also support the corresponding feature.
- \* This router may not support all the mandatory features as ratified in Draft 3.0 of IEEE 802.11ax specification.
- \* Further software upgrades for feature availability may be required.

## Chapter 1

---

# Get to Know About Your Router

---

This chapter introduces what the router can do and shows its appearance.

It chapter contains the following sections:

- [Product Overview](#)
- [Appearance](#)

## 1.1. Product Overview

TP-Link AXE router, with the 802.11ax Wi-Fi technology and the brand-new 6 GHz band, achieves Wi-Fi performance at its ultimate level. The revolutionary combination of OFDMA and 1024QAM improve throughput by 4 times and dramatically increase capacity and efficiency of the whole network. Access to the 6 GHz band brings more bandwidth, faster speeds, and lower latency, opening up resources for future innovations like in AR/VR, 8K streaming and more.

Moreover, it is simple and convenient to set up and use the TP-Link router due to its intuitive Tether app and powerful web interface.

## 1.2. Appearance

### 1.2.1. Top Panel









The router's LEDs (view from left to right) are located on the front. You can check the router's working status by following the LED Explanation table.

#### LED Explanation

Name	Status	Indication
 (Power)	On	The system has started up successfully.
	Flashing	The system is starting up, updating the firmware, or establishing WPS connection. Do not disconnect or power off your router.
	Off	Power is off.



Name	Status	Indication
 (2.4 GHz Wireless)	On	The 2.4 GHz wireless band is enabled.
	Off	The 2.4 GHz wireless band is disabled.
 (5 GHz Wireless)	On	The 5 GHz wireless band is enabled.
	Off	The 5 GHz wireless band is disabled.
 (6 GHz Wireless)	On	The 6 GHz wireless band is enabled.
	Off	The 6 GHz wireless band is disabled.
 (Internet)	Green On	Internet service is available.
	Orange On	The router's Internet port is connected, but the internet service is not available.
	Off	The router's Internet port is unplugged.
 (Ethernet)	On	At least one powered-on device is connected to the router's Ethernet port.
	Off	No powered-on device is connected to the router's Ethernet port.
 (USB)	On	The inserted USB device is ready to use.
	Blinking	A USB device is being identified.
	Off	No device is plugged into the USB port.

### 1.2.2. Back Panel



The following parts (view from left to right) are located on the back panel.

Item	Description
LED Button	Press the button for 1 second to turn on or off the LEDs of your router.
WPS Button	Press the button for 1 second, and immediately initiate WPS on your client device to start the WPS process.
Wi-Fi Button	Press and hold the button for more than 2 seconds to turn on or off the wireless function of your router.
Reset Button	Press and hold the button for about 6 seconds until the Power LED blinks to reset the router to its factory default settings.
LAN Port (1-4)	For connecting your PC or other wired devices to the router.
WAN Port	For connecting to a modem or an Ethernet outlet.
Power On/Off Button	Press this button to power on or off the router.
Power Port	For connecting the router to a power socket via the provided power adapter.

### 1.2.3. Side Panel



The following part is located on the side panel.

Item	Description
USB 3.0 Port	For connecting a USB storage device to the router.

## Chapter 2

---

# Connect the Hardware

---

This chapter contains the following sections:

- [Position Your Router](#)
- [Connect Your Router](#)

## 2.1. Position Your Router

- The product should not be located in a place where it will be exposed to moisture or excessive heat.
- Place the router in a location where it can be connected to multiple devices as well as to a power source.
- Make sure the cables and power cord are safely placed out of the way so they do not create a tripping hazard.
- The router can be placed on a shelf or desktop.
- Keep the router away from devices with strong electromagnetic interference, such as Bluetooth devices, cordless phones and microwaves.
- Generally, the router is placed on a horizontal surface, such as on a shelf or desktop. The device also can be mounted on the wall as shown in the following figure.

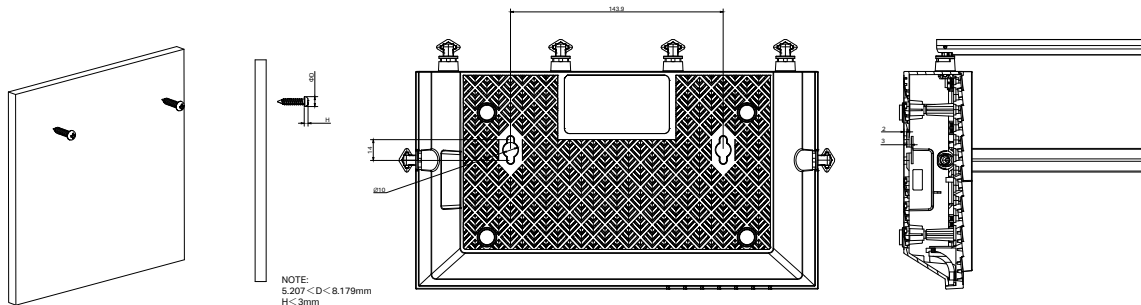

### Note:

The diameter of the screw head,  $5.207\text{mm} < D < 8.179\text{mm}$ , and the distance of two screws is  $143.9\text{mm}$ . The screw that project from the wall need around  $5\text{mm}$  based, and the length of the screw need to be at least  $20\text{mm}$  to withstand the weight of the product.

## 2.2. Connect Your Router

### Before you start:

- 1) Turn off your modem, if any, and remove the backup battery if it has one.
- 2) Place the router horizontally and orient the antennas vertically.

If your internet comes from an Ethernet outlet instead of a DSL / Cable / Satellite modem, connect the router's WAN port to it, then follow steps 3 and 4 to complete the hardware connection.

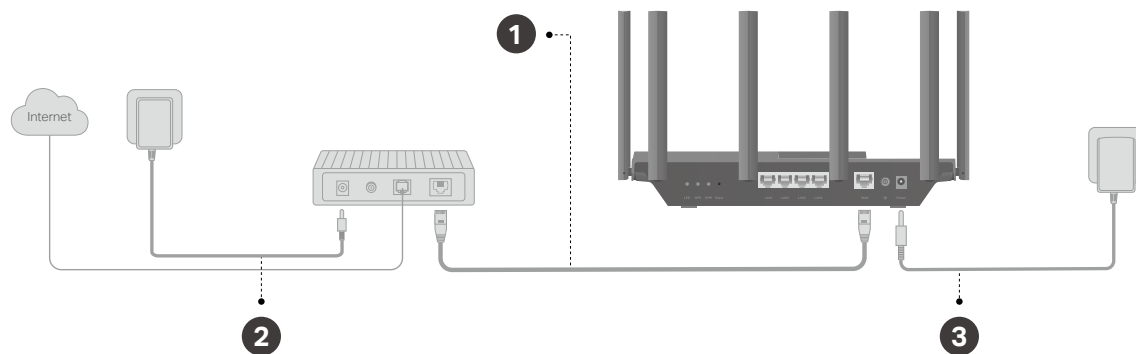

1. Connect the **powered-off modem** to the router's **WAN port** with an Ethernet cable.
2. Turn on the modem, and then wait about **2 minutes** for it to restart.
3. Connect the power adapter to the router and turn on the router.
4. Verify that the hardware connection is correct by checking the following LEDs.



**Note:** If the 2.4 GHz, 5 GHz, and 6 GHz LEDs are off, press and hold the Wi-Fi button on the back for more than 2 seconds. These LEDs should turn solid on.

5. Connect your computer to the router.

- **Method 1: Wired**

Turn off the Wi-Fi on your computer and connect the devices as shown below.

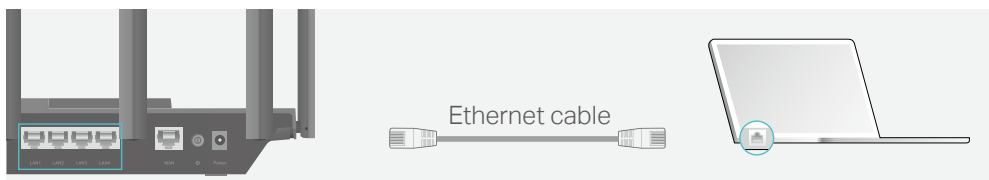

- **Method 2: Wirelessly**

- 1) Find the SSIDs (Network Names) and Wireless Password printed on the label at the bottom of the router.
- 2) Click the network icon of your computer or go to Wi-Fi Settings of your smart device, and then select the SSID to join the network.

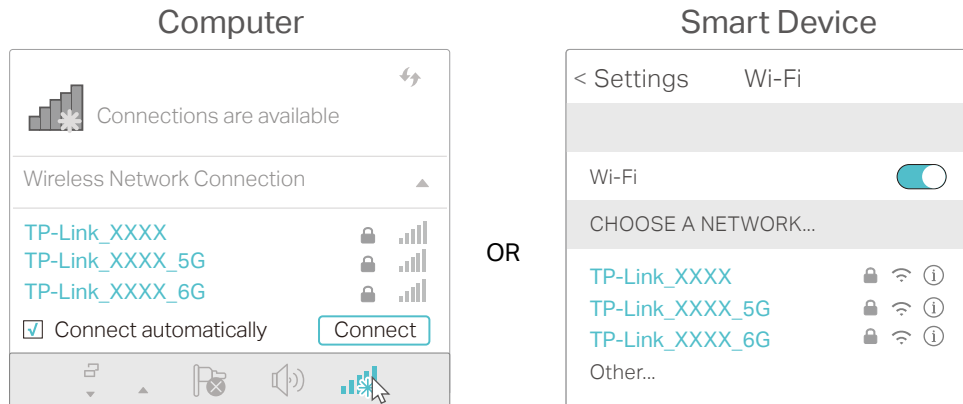

### • Method 3: Use the WPS button

Wireless devices that support WPS, including Android phones, tablets, and most USB network cards, can be connected to your router through this method.

#### Note:

- WPS is not supported by iOS devices.
- The WPS function cannot be configured if the wireless function of the router is disabled. Also, the WPS function will be disabled if your wireless encryption is WEP. Please make sure the wireless function is enabled and is configured with the appropriate encryption before configuring the WPS.

- 1) Tap the WPS icon on the device's screen. Here we take an Android phone for instance.
- 2) Within two minutes, press the WPS button on your router.

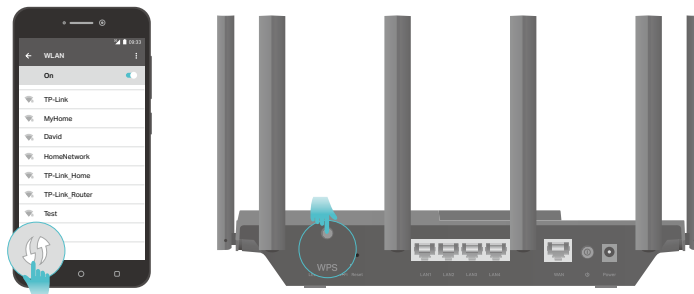

## Chapter 3

---

# Log In to Your Router

---

With a web-based utility, it is easy to configure and manage the router. The web-based utility can be used on any Windows, Mac OS or UNIX OS with a Web browser, such as Microsoft Internet Explorer, Mozilla Firefox or Apple Safari.

Follow the steps below to log in to your router.

1. Set up the TCP/IP Protocol in [Obtain an IP address automatically](#) mode on your computer.
2. Visit <http://tplinkwifi.net>, and create a login password for secure management purposes. Then click [Let's Get Started](#) to log in.

**Note:** If the login window does not appear, please refer to the [FAQ](#) Section.

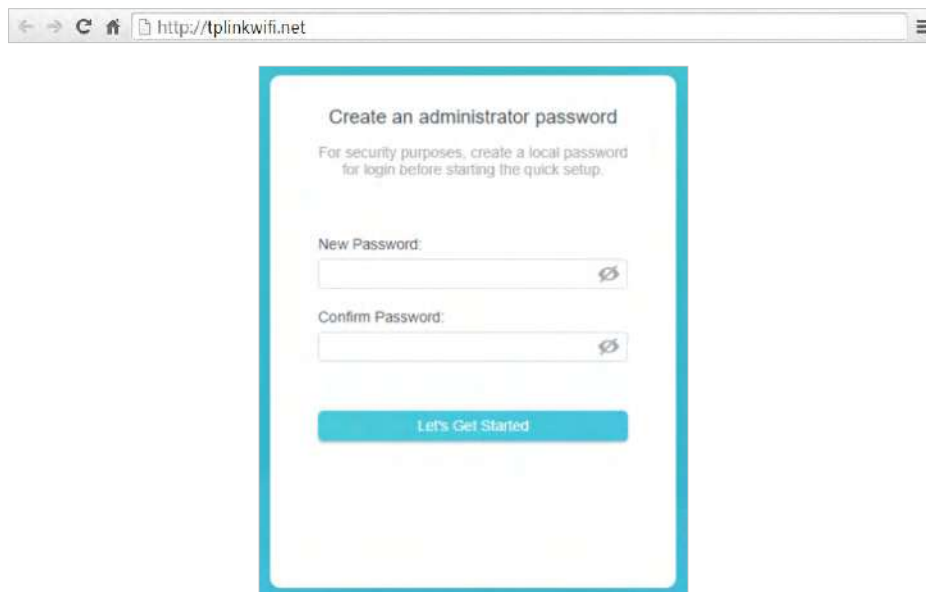

The image shows a web browser window with the address bar displaying <http://tplinkwifi.net>. The main content area of the browser shows a form titled "Create an administrator password". Below the title, there is a sub-header: "For security purposes, create a local password for login before starting the quick setup." The form contains two input fields: "New Password:" and "Confirm Password:", each with a toggle icon to the right. At the bottom of the form is a blue button labeled "Let's Get Started".



## Chapter 4

---

# Set Up Internet Connection

---

This chapter introduces how to connect your router to the internet. The router is equipped with a web-based Quick Setup wizard. It has necessary ISP information built in, automates many of the steps and verifies that those steps have been successfully completed. Furthermore, you can also set up an IPv6 connection if your ISP provides IPv6 service.

It contains the following sections:

- [Use Quick Setup Wizard](#)
- [Quick Setup Via TP-Link Tether App](#)
- [Manually Set Up Your Internet Connection](#)
- [Set Up the Router as an Access Point](#)
- [Set Up an IPv6 Internet Connection](#)

## 4.1. Use Quick Setup Wizard

The Quick Setup Wizard will guide you to set up your router.

☞ **Tips:**

If you need the IPv6 internet connection, please refer to the section of [Set Up an IPv6 Internet Connection](#).

Follow the steps below to set up your router.

1. Visit <http://tplinkwifi.net>, and log in with the password you set for the router.
2. Follow the step-by-step instructions to complete Quick Setup configuration or go to [Advanced](#) > [Quick Setup](#) for configuration to connect your router to the internet. Then follow the step-by-step instructions to connect your router to the internet.
3. To enjoy a more complete service from TP-Link (remote management, TP-Link DDNS, and more.), log in with your TP-Link ID or click [Sign Up Now](#) to get one. Then follow the instructions to bind the cloud router to your TP-Link ID.

Get TP-Link Cloud Service

Log in to bind the router to your TP-Link ID. You can manage your network remotely via the Tether app, get notified of the latest firmware updates and more.

TP-Link ID (Email):

Password:

LOG IN

[Sign Up Now](#) [Forgot Password?](#)

SKIP

📌 **Note:**

- To learn more about the TP-Link Cloud service, please refer to the [TP-Link Cloud Service](#) section.
- If you do not want to register a TP-Link ID now, you may click [Skip](#) to proceed.
- If you have changed the preset wireless network name (SSID) and wireless password during the Quick Setup process, all your wireless devices must use the new SSID and password to connect to the router.

## 4.2. Quick Setup Via TP-Link Tether App

The Tether app runs on iOS and Android devices, such as smartphones and tablets.

1. Launch the Apple App Store or Google Play store and search “[TP-Link Tether](#)” or simply scan the QR code to download and install the app.



2. Launch the Tether app and log in with your TP-Link ID.

**Note:** If you don't have a TP-Link ID, create one first.

3. Tap the **+** button and select **Wireless Router > Standard Routers**. Follow the steps to complete the setup and connect to the internet.

4. Connect your devices to the newly configured wireless networks of the router and enjoy the internet!

### 4.3. Manually Set Up Your Internet Connection

In this part, you can check your current internet connection settings. You can also modify the settings according to the service information provided by your ISP.

Follow the steps below to check or modify your internet connection settings.

1. Visit <http://tplinkwifi.net>, and log in with your TP-Link ID or the password you set for the router.
2. Go to **Internet**.
3. Select your internet connection type from the drop-down list.

**Internet**

Set up an internet connection with the service information provided by your ISP (internet service provider).

Internet Connection Type:

Select this type if your ISP doesn't provide any information for internet connection.

4. Follow the instructions on the page to continue the configuration. Parameters on the figures are just used for demonstration.

- 1) If you choose **Dynamic IP**, you need to select whether to clone the MAC address. Dynamic IP users are usually equipped with a cable TV or fiber cable.

**Internet**

Set up an internet connection with the service information provided by your ISP (internet service provider).

Internet Connection Type:  

Select this type if your ISP doesn't provide any information for internet connection.

Set the MAC address of your router. Use the default address unless your ISP allows internet access from only a specific MAC address.

**MAC Clone**

Router MAC Address:  

- 2) If you choose **Static IP**, enter the information provided by your ISP in the corresponding fields.

**Internet**

Set up an internet connection with the service information provided by your ISP (internet service provider).

Internet Connection Type:  

Select this type if your ISP provides specific IP parameters.

IP Address:

Subnet Mask:

Default Gateway:

Primary DNS:

Secondary DNS:  (Optional)

- 3) If you choose **PPPoE**, enter the **username** and **password** provided by your ISP. PPPoE users usually have DSL cable modems.

**Internet**

Set up an internet connection with the service information provided by your ISP (internet service provider).

Internet Connection Type:  

Select this type if your ISP only provides a username and password.

Username:

Password:   

- 4) If you choose **L2TP**, enter the **username** and **password** and choose the **Secondary Connection** provided by your ISP. Different parameters are needed according to the Secondary Connection you have chosen.

### Internet

Set up an internet connection with the service information provided by your ISP (internet service provider).

Internet Connection Type: **L2TP**

Select this type if your ISP provides L2TP VPN server information and an account. Some ISPs also provide specific IP parameters.

Username:

Password:

Dynamic IP  
 Static IP

VPN Server IP/Domain Name:

- 5) If you choose **PPTP**, enter the **username** and **password**, and choose the **Secondary Connection** provided by your ISP. Different parameters are needed according to the Secondary Connection you have chosen.

### Internet

Set up an internet connection with the service information provided by your ISP (internet service provider).

Internet Connection Type: **PPTP**

Select this type if your ISP provides PPTP VPN server information and an account. Some ISPs also provide specific IP parameters.

Username:

Password:

Dynamic IP  
 Static IP

VPN Server IP/Domain Name:

5. Click **SAVE**.

 **Tips:**

- If you use **Dynamic IP** and **PPPoE** and you are provided with any other parameters that are not required on the page, please go to **Advanced > Network > Internet** to complete the configuration.
- If you still cannot access the internet, refer to the **FAQ** section for further instructions.

## 4.4. Set Up the Router as an Access Point

The router can work as an access point, transforming your existing wired network to a wireless one.

1. Visit <http://tplinkwifi.net>, and log in with your TP-Link ID or the password you set for the router.
2. Go to **Advanced** > **System** > **Operation Mode**, select **Access Point** and click **SAVE**. The router will reboot and switch to Access Point mode.

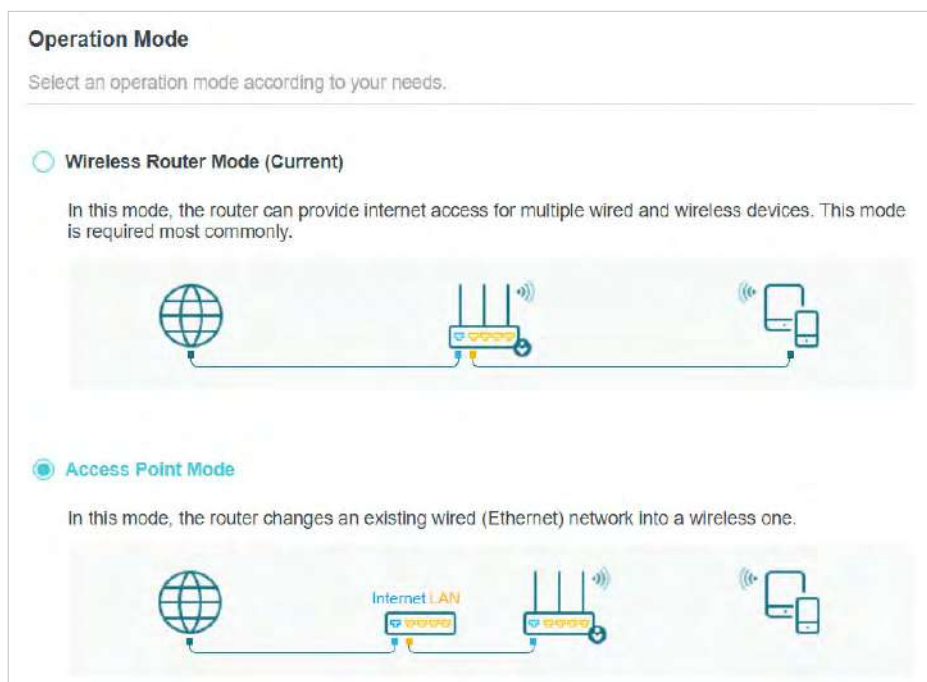

3. After rebooting, connect the router to your existing wired router via an Ethernet cable.
4. Log in again to the web management page <http://tplinkwifi.net>, and go to **Advanced** > **Quick Setup**.
5. Configure your wireless settings and click **Next**.
6. Confirm the information and click **SAVE**. Now, you can enjoy Wi-Fi.

☞ **Tips:**

- Functions, such as Parental Controls, QoS and NAT Forwarding, are not supported in the Access Point mode.
- Functions, such as Guest Network, are the same as those in the Router mode.

## 4.5. Set Up an IPv6 Internet Connection

Your ISP provides information about one of the following IPv6 internet connection types: PPPoE, Dynamic IP(SLAAC/DHCPv6), Static IP, 6to4 tunnel, Pass-Through (Bridge).

1. Visit <http://tplinkwifi.net>, and log in with your TP-Link ID or the password you set for the router.

2. Go to [Advanced](#) > [IPv6](#).

3. Enable IPv6 and select the internet connection type provided by your ISP.

**Tips:**

If you do not know what your internet connection type is, contact your ISP or judge according to the already known information provided by your ISP.

4. Fill in information as required by different connection types.

1) [Static IP](#): Fill in blanks and click [SAVE](#).

**IPv6 Internet**

Set up an IPv6 internet connection using the information provided by your ISP (internet service provider).

IPv6:

Internet Connection Type:

IPv6 Address:

Default Gateway:

Primary DNS:

Secondary DNS:

MTU Size:   
bytes. (The default is 1500, do not change unless necessary.)

2) [Dynamic IP\(SLAAC/DHCPv6\)](#): Click [Advanced](#) to input further information if your ISP requires. Click [SAVE](#) and then click [Renew](#).

**IPv6 Internet**

Set up an IPv6 internet connection using the information provided by your ISP (internet service provider).

IPv6:

Internet Connection Type:

IPv6 Address:

Primary DNS:

Secondary DNS:

[▶ Advanced Settings](#)

3) [PPPoE](#): By default, the router uses the IPv4 account to connect to the IPv6 server. Click [Advanced](#) to input further information if your ISP requires. Click [SAVE](#) and then click [Connect](#).

**Note:**

If your ISP provides two separate accounts for the IPv4 and IPv6 connections, manually enter the username and password for the IPv6 connection.

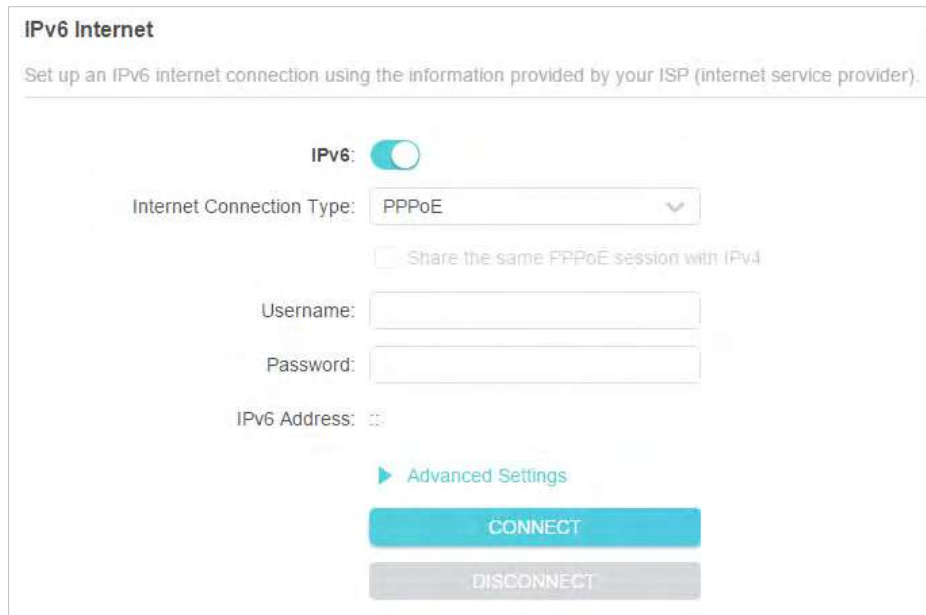

**IPv6 Internet**

Set up an IPv6 internet connection using the information provided by your ISP (internet service provider).

IPv6:

Internet Connection Type: PPPoE

Share the same PPPoE session with IPv4

Username:

Password:

IPv6 Address:

[Advanced Settings](#)

**CONNECT**

DISCONNECT

- 4) **6to4 Tunnel:** An IPv4 internet connection type is a prerequisite for this connection type ([Manually Set Up Your Internet Connection](#)). Click **Advanced** to input further information if your ISP requires. Click **SAVE** and then click **Connect**.

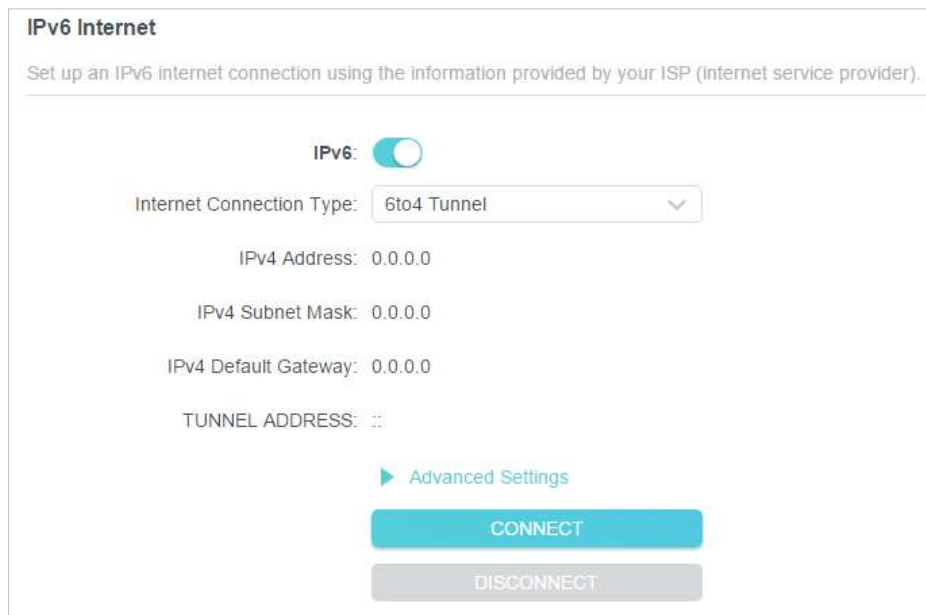

**IPv6 Internet**

Set up an IPv6 internet connection using the information provided by your ISP (internet service provider).

IPv6:

Internet Connection Type: 6to4 Tunnel

IPv4 Address: 0.0.0.0

IPv4 Subnet Mask: 0.0.0.0

IPv4 Default Gateway: 0.0.0.0

TUNNEL ADDRESS:

[Advanced Settings](#)

**CONNECT**

DISCONNECT

- 5) **Pass-Through (Bridge):** Click **SAVE** and skip to Step 6.



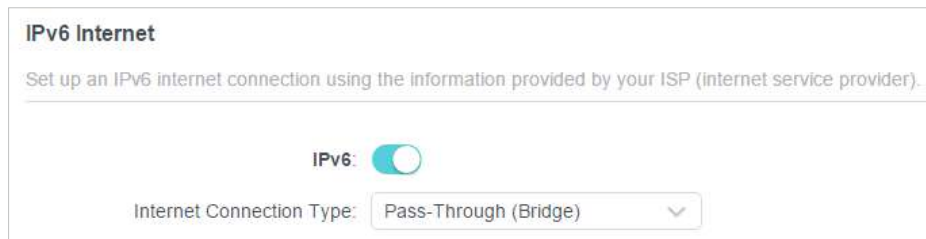

**IPv6 Internet**

Set up an IPv6 internet connection using the information provided by your ISP (internet service provider).

IPv6:

Internet Connection Type:

5. Configure LAN ports. Windows users are recommended to choose from the first two types. Fill in [Address Prefix](#) provided by your ISP, and click [SAVE](#).

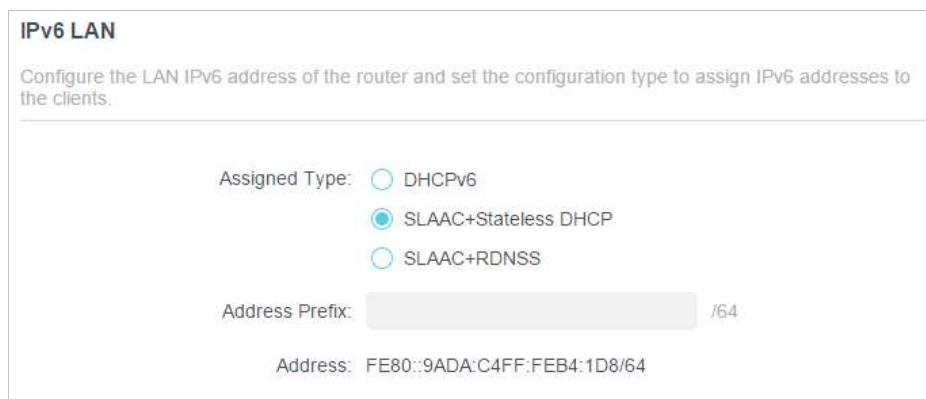

**IPv6 LAN**

Configure the LAN IPv6 address of the router and set the configuration type to assign IPv6 addresses to the clients.

Assigned Type:  DHCPv6  
 SLAAC+Stateless DHCP  
 SLAAC+RDNSS

Address Prefix:  /64

Address: FE80::9ADA:C4FF:FEB4:1D8/64

6. Click [Status](#) to check whether you have successfully set up an IPv6 connection.

**Tips:**

Visit the [FAQ](#) section if there is no internet connection.

## Chapter 5

---

# TP-Link Cloud Service

---

TP-Link Cloud service provides a better way to manage your cloud devices. Log in to your router with a TP-Link ID, and you can easily monitor and manage your home network when you are out and about via the Tether app. To ensure that your router stays new and gets better over time, the TP-Link Cloud will notify you when an important firmware upgrade is available. Surely you can also manage multiple TP-Link Cloud devices with a single TP-Link ID.

This chapter introduces how to register a new TP-Link ID, bind or unbind TP-Link IDs to manage your router, and the Tether app with which you can manage your home network no matter where you may find yourself.

It contains the following sections:

- [Register a TP-Link ID](#)
- [Change Your TP-Link ID Information](#)
- [Manage the User TP-Link IDs](#)
- [Manage the Router via the TP-Link Tether App](#)

## 5.1. Register a TP-Link ID

If you have skipped the registration during the Quick Setup process, you can:

1. Visit <http://tplinkwifi.net>, and log in with the password you set for the router.
2. Go to [Advanced > TP-Link ID](#) or click [TP-Link ID](#) on the very top of the page.
3. Click [Sign Up](#) and follow the instructions to register a TP-Link ID.

**TP-Link ID**

Log in to bind the router to your TP-Link ID. You can remotely manage your network via the Tether app, and more.

TP-Link ID (Email):

Password:

[Log In](#)

[Sign Up](#) [Forgot Password?](#)

4. After activating your TP-Link ID, come back to the TP-Link ID page to log in. The TP-Link ID used to log in to the router for the first time will be automatically bound as an [Admin](#).

**Note:**

- To learn more about the [Admin](#) and [User](#) TP-Link ID, refer to [Manage the User TP-Link IDs](#).
- Once you have registered a TP-Link ID on the web management page, you can only register another TP-Link ID via the Tether APP. Please refer to [Manage the Router via the TP-Link Tether App](#) to install the app.
- If you want to unbind the admin TP-Link ID from your router, please go to [Advanced > TP-Link ID](#), and click [Unbind](#) in the [Device Information](#) section.

## 5.2. Change Your TP-Link ID Information

Follow the steps below to change your email address and password of your TP-Link ID as needed.

1. Visit <http://tplinkwifi.net>, and log in with your TP-Link ID.
2. Go to [Advanced > TP-Link ID](#), and focus on the [Account Information](#) section.

- **To change your email address:**

1. Click  behind the Email.
2. Enter the password of your TP-Link ID, then a new email address. And click [SAVE](#).

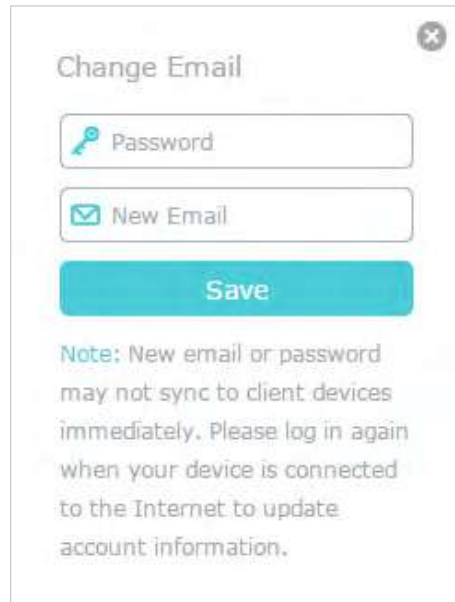

The image shows a 'Change Email' dialog box with a close button (X) in the top right corner. It contains two input fields: 'Password' with a key icon and 'New Email' with an envelope icon. Below the fields is a teal 'Save' button. A note at the bottom states: 'Note: New email or password may not sync to client devices immediately. Please log in again when your device is connected to the Internet to update account information.'

- **To change your password:**

1. Click  behind the Password.
2. Enter the current password, then a new password twice. And click **SAVE**.

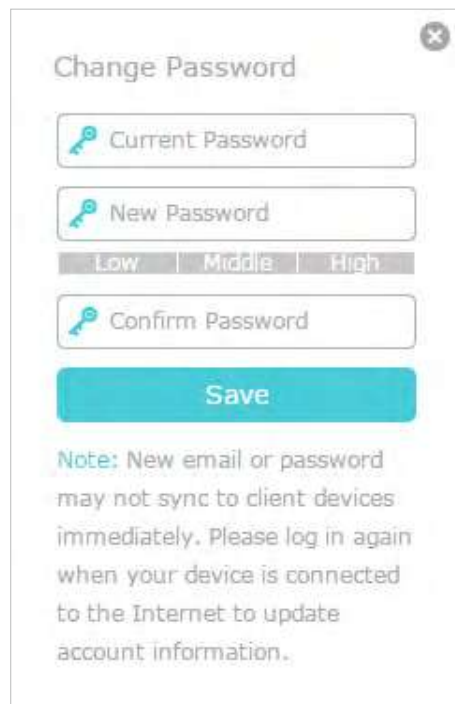

The image shows a 'Change Password' dialog box with a close button (X) in the top right corner. It contains three input fields: 'Current Password', 'New Password', and 'Confirm Password', each with a key icon. Below the 'New Password' field is a strength indicator with three segments labeled 'Low', 'Middle', and 'High'. Below the fields is a teal 'Save' button. A note at the bottom states: 'Note: New email or password may not sync to client devices immediately. Please log in again when your device is connected to the Internet to update account information.'

### 5.3. Manage the User TP-Link IDs

The TP-Link ID used to log in to the router for the first time will be automatically bound as the **Admin** account. An admin account can add or remove other TP-Link IDs to or

from the same router as **Users**. All accounts can monitor and manage the router locally or remotely, but user accounts cannot:

- Reset the router to its factory default settings either on the web management page or in the Tether app.
- Add/remove other TP-Link IDs to/from the router.

### 5.3.1. Add TP-Link ID to Manage the Router

1. Visit <http://tplinkwifi.net>, and log in with your TP-Link ID.
2. Go to **Advanced > TP-Link ID**, and focus on the **Bound Accounts** section.
3. Click **+ Bind**, enter another TP-Link ID as needed and click **SAVE**.

**Note:** If you need another TP-Link ID, please register a new one via the Tether app. Refer to [Manage the Router via the TP-Link Tether App](#) to install the app and register a new TP-Link ID.

4. The new TP-Link ID will be displayed in the Bound Accounts table as a **User**.

Bound Accounts				
<input type="checkbox"/>	ID	Email	Binding Date	Role
<input type="checkbox"/>	1	...	...	Admin
<input type="checkbox"/>	2	...	...	User

### 5.3.2. Remove TP-Link ID(s) from Managing the Router

1. Visit <http://tplinkwifi.net>, and log in with your TP-Link ID.
2. Go to **Advanced > TP-Link ID**, and focus on the **Bound Accounts** section.
3. Tick the checkbox(es) of the TP-Link ID(s) you want to remove and click **Unbind**.

Bound Accounts				
<span style="color: green;">+</span> Bind <span style="color: red;">-</span> Unbind				
<input type="checkbox"/>	ID	Email	Binding Date	Role
<input type="checkbox"/>	1	...	...	Admin
<input checked="" type="checkbox"/>	2	...	...	User

## 5.4. Manage the Router via the TP-Link Tether App

The Tether app runs on iOS and Android devices, such as smartphones and tablets.

1. Launch the Apple App Store or Google Play store and search “TP-Link Tether” or simply scan the QR code to download and install the app.



2. Launch the Tether app and log in with your TP-Link ID.

**Note:** If you don't have a TP-Link ID, create one first.

3. Connect your device to the router's wireless network.
4. Go back to the Tether app, select the model of your router and log in with the password you set for the router.
5. Manage your router as needed.

**Note:** If you need to remotely access your router from your smart devices, you need to:

- Log in with your TP-Link ID. If you don't have one, refer to [Register a TP-Link ID](#).
- Make sure your smartphone or tablet can access the internet with cellular data or a Wi-Fi network.

## Chapter 6

---

# Wireless Settings

---

This chapter guides you on how to configure the wireless settings.

It contains the following sections:

- [Specify Wireless Settings](#)
- [Schedule Your Wireless Function](#)
- [Use WPS for Wireless Connection](#)
- [Advanced Wireless Settings](#)

## 6.1. Specify Wireless Settings

The router's wireless network names (SSIDs), password, and security option are preset in the factory. The preset SSIDs and password can be found on the label of the router. You can customize the wireless settings according to your needs.

1. Visit <http://tplinkwifi.net>, and log in with your TP-Link ID or the password you set for the router.
2. Go to [Wireless](#) or [Advanced > Wireless > Wireless Settings](#).

**Wireless Settings**

Personalize settings for each band or enable Smart Connect to configure the same settings for 2.4GHz and 5GHz bands.

---

**OFDMA:**  Enable ?

**TWT:**  Enable ?

**Smart Connect:**  Enable ?

**2.4GHz/5GHz:**  Enable Sharing Network

Network Name (SSID):   Hide SSID

Security:

Password:

2.4GHz Channel Width:

2.4GHz Channel:

5GHz Channel Width:

5GHz Channel:

The channel you've selected may overlap with DFS channels. This will require some waiting time to meet regulatory radar detection requirements.

**6GHz:**  Enable Sharing Network

Network Name (SSID):   Hide SSID

Security:

Password:

Channel Width:

Channel:  Enable PSC ?

Mode: 802.11ax only

- **To enable or disable OFDMA:**

OFDMA enables multiple users to transmit data simultaneously, and thus greatly improves speed and efficiency. Noted that only when your clients also support OFDMA, can you fully enjoy the benefits. It is disabled by default.



1. Go to [Advanced](#) > [Wireless](#) > [Wireless Settings](#).

2. Enable [OFDMA](#).

- **To enable or disable TWT:**

TWT (Target Wake Time) allows 802.11ax routers and clients to negotiate their periods to transmit and receive data packets. Clients only wake up at TWT sessions and remain in sleep mode for the rest of the time, which significantly extend their battery life. It is disabled by default.

1. Go to [Advanced](#) > [Wireless](#) > [Wireless Settings](#).

2. Enable [TWT](#).

- **To use the Smart Connect function:**

Smart Connect combines the 2.4 GHz and 5 GHz bands and assigns your devices between them to balance network demands, while leaving the brand-new 6 GHz band exclusive for your Wi-Fi 6E devices to unleash the most out of the latest Wi-Fi.

1. Go to [Advanced](#) > [Wireless](#) > [Wireless Settings](#).

2. Enable [Smart Connect](#).



3. Keep the default values or set a new SSID and password, and click [SAVE](#). This SSID and password will be applied for the 2.4 GHz and 5 GHz wireless networks. If you want to configure the wireless settings separately for each band, deselect the checkbox to disable this feature.

- **To enable or disable the wireless function:**

1. Go to [Wireless](#) or [Advanced](#) > [Wireless](#) > [Wireless Settings](#).

2. The wireless bands are enabled by default. If you want to disable a wireless band, just deselect its [Enable](#) checkbox.

- **To change the wireless network name (SSID) and wireless password:**

1. Go to [Wireless](#) or [Advanced](#) > [Wireless](#) > [Wireless Settings](#).

2. Create a new SSID in [Network Name \(SSID\)](#) and customize the password for the network in [Password](#). The value is case-sensitive.

**Note:** If you change the wireless settings with a wireless device, you will be disconnected when the settings are effective. Please write down the new SSID and password for future use.

- **To hide SSID:**

1. Go to [Wireless](#) or [Advanced](#) > [Wireless](#) > [Wireless Settings](#).

2. Select [Hide SSID](#), and your SSID won't display when you scan for local wireless networks on your wireless device and you need to manually join the network.

- **To change the security option:**

1. Go to [Advanced](#) > [Wireless](#) > [Wireless Settings](#).
2. Select an option from the [Security](#) drop-down list. We recommend you don't change the default settings unless necessary.

- **To change the transmit power:**

1. Go to [Advanced](#) > [Wireless](#) > [Wireless Settings](#).
2. Select an option from the [Transmit Power](#) drop-down list: [High](#), [Middle](#) or [Low](#). The default and recommended setting is [High](#).

- **To change channel settings:**

1. Go to [Advanced](#) > [Wireless](#) > [Wireless Settings](#).
2. Select a [Channel Width](#) (bandwidth) for the wireless network. It is recommended to just leave it as default.
3. Select an operating [Channel](#) for the wireless network. It is recommended to leave the channel to [Auto](#) if you are not experiencing the intermittent wireless connection issue.

For the 6 GHz network, you can select the [Enable PSC](#) checkbox. When PSC (Preferred Scanning Channel) is enabled, only channels with higher connectivity will be reserved to ensure 6 GHz device connections.

- **To change the transmission mode:**

1. Go to [Advanced](#) > [Wireless](#) > [Wireless Settings](#).
2. For the 2.4 GHz and 5 GHz networks, disable [Smart Connect](#), then select a [transmission Mode](#) according to your wireless client devices. It is recommended to just leave it as default.

The 6 GHz network only supports 802.11ax mode, which cannot be changed.

## 6.2. Schedule Your Wireless Function

The wireless network can be automatically off at a specific time when you do not need the wireless connection.

1. Visit <http://tplinkwifi.net>, and log in with your TP-Link ID or the password you set for the router.
2. Go to [Advanced](#) > [Wireless](#) > [Wireless Schedule](#).
3. Enable the [Wireless Schedule](#) feature.

**Wireless Schedule**

Schedule when to automatically turn off your wireless network.

---

**Wireless Schedule:**  Enable

- Click [Add](#) to specify a wireless off period during which you need the wireless off automatically, and click [SAVE](#).

Add Schedule
✕

Wireless Off Time: From

To   (next day)

Repeat:  S  M  T  W  T  F  S

**Note:**

- The Effective Time Schedule is based on the time of the router. You can go to [Advanced](#) > [System](#) > [Time & Language](#) to modify the time.
- The wireless network will be automatically turned on after the time period you set.

## 6.3. Use WPS for Wireless Connection

Wi-Fi Protected Setup (WPS) provides an easier approach to set up a security-protected Wi-Fi connection.

- Visit <http://tplinkwifi.net>, and log in with your TP-Link ID or the password you set for the router.
- Make sure the Wi-Fi of your router is on and go to [Advanced](#) > [Wireless](#) > [WPS](#).

### 6.3.1. Connect via the Client's PIN

Enter the PIN of your device and click [Connect](#). Then your device will get connected to the router.

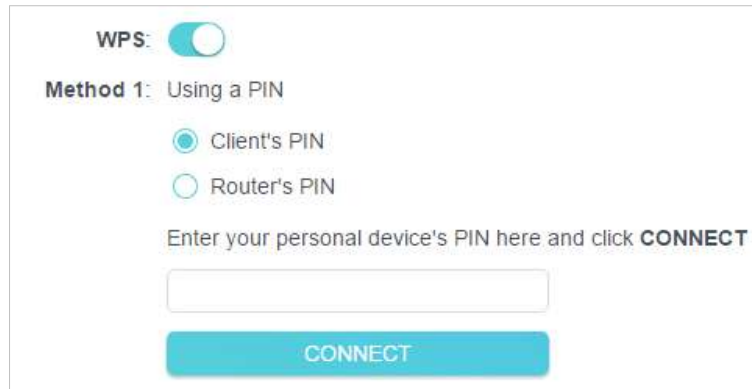

WPS:

**Method 1:** Using a PIN

Client's PIN

Router's PIN

Enter your personal device's PIN here and click **CONNECT**

**CONNECT**

### 6.3.2. Connect via the Router's PIN

Select **Router's PIN** in **Method 1** to enable **Router's PIN**. You can use the default PIN or generate a new one.

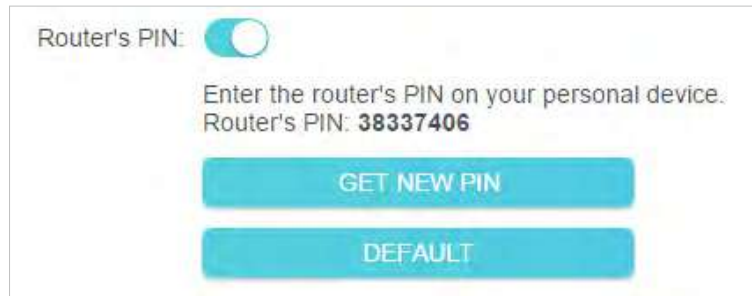

Router's PIN:

Enter the router's PIN on your personal device.  
Router's PIN: **38337406**

**GET NEW PIN**

**DEFAULT**

**Note:**

PIN (Personal Identification Number) is an eight-character identification number preset to each router. WPS supported devices can connect to your router with the PIN. The default PIN is printed on the label of the router.

### 6.3.3. Push the WPS Button

Click **Start** on the screen or directly press the router's WPS button. Within two minutes, enable WPS on your personal device. **Success** will appear on the screen and the WPS LED of the router should change from flashing to solid on, indicating successful WPS connection.

**Method 2:** Using the button below

Click the button below, then enable WPS on your personal device within 2 minutes.

**Method 3:** Using the router's WPS button

Press the router's WPS button, then enable WPS on your personal device within 2 minutes.

## 6.4. Advanced Wireless Settings

Check advanced wireless settings for your device.

1. Visit <http://tplinkwifi.net>, and log in with your TP-Link ID or the password you set for the router.
2. Go to [Advanced](#) > [Wireless](#) > [Additional Settings](#).
3. Configure advanced wireless settings.

### Additional Settings

Check advanced wireless settings for your device.

---

WMM:  Enable

AP Isolation:  Enable

Airtime Fairness:  Enable

Beacon Interval:

RTS Threshold:

DTIM Interval:

Group Key Update Period:  s

- **WMM** - WMM function can guarantee the packets with high-priority messages being transmitted preferentially.

- **AP Isolation** - This function isolates all connected wireless stations so that wireless stations cannot access each other through WLAN.
- **Airtime Fairness** - This function can improve the overall network performance by sacrificing a little bit of network time on your slow devices.
- **Beacon Interval** - Enter a value between 40 and 1000 in milliseconds to determine the duration between beacon packets that are broadcasted by the router to synchronize the wireless network. The default value is 100 milliseconds.
- **RTS Threshold**- Enter a value between 1 and 2346 to determine the packet size of data transmission through the router. By default, the RTS (Request to Send) Threshold size is 2346. If the packet size is greater than the preset threshold, the router will send RTS frames to a particular receiving station and negotiate the sending of a data frame.
- **DTIM Interval** - The value determines the interval of DTIM (Delivery Traffic Indication Message). Enter a value between 1 and 15 intervals. The default value is 1, which indicates the DTIM Interval is the same as Beacon Interval.
- **Group Key Update Period** - Enter a number of seconds (minimum 30) to control the time interval for the encryption key automatic renewal. The default value is 0, meaning no key renewal.

## Chapter 7

---

# Guest Network

---

This function allows you to provide Wi-Fi access for guests without disclosing your main network. When you have guests in your house, apartment, or workplace, you can create a guest network for them. In addition, you can customize guest network options to ensure network security and privacy.

It contains the following sections:

- [Create a Network for Guests](#)
- [Customize Guest Network Options](#)

## 7.1. Create a Network for Guests

1. Visit <http://tplinkwifi.net>, and log in with your TP-Link ID or the password you set for the router.
2. Go to **Advanced > Wireless > Guest Network** or click **Wireless** on the top page. Locate the **Guest Network** section.
3. Create a guest network as needed.
  - 1) Tick the Enable checkbox for the 2.4GHz, 5 GHz-1 or 5GHz-2 wireless network.
  - 2) Customize the SSID. Don't select **Hide SSID** unless you want your guests to manually input the SSID for guest network access.
  - 3) Select the **Security** type and customize your own password. If **No security** is selected, no password is needed to access your guest network.

**Guest Network**  
Enable the wireless bands you want your guests to use and complete the related information.

**2.4GHz:**  Enable [Sharing Network](#)  
Network Name (SSID):   Hide SSID

**5GHz:**  Enable [Sharing Network](#)  
Network Name (SSID):   Hide SSID

**6GHz:**  Enable [Sharing Network](#)  
Network Name (SSID):   Hide SSID

Security:

Password:

4. Click **SAVE**. Now your guests can access your guest network using the SSID and password you set!
5. You can also click **Sharing Network** to share the SSID and password to your guests.

**2.4GHz:**  Enable [Sharing Network](#)

Network Name (SSID):

**SSID:**   
TP-Link\_Guest\_3933

**Password:**

### Tips:

To view guest network information, go to **Network Map** and locate the **Guest Network** section. You can turn on or off the guest network function conveniently.



## 7.2. Customize Guest Network Options

1. Visit <http://tplinkwifi.net>, and log in with your TP-Link ID or the password you set for the router.
2. Go to [Advanced](#) > [Wireless](#) > [Guest Network](#). Locate the [Guest Permissions](#) section.
3. Customize guest network options according to your needs.

**Guest Permissions**

Control the data that guests can access.

---

Allow guests to see each other

Allow guests to access your local network

- [Allow guests to see each other](#)

Tick this checkbox if you want to allow the wireless clients on your guest network to communicate with each other via methods such as network neighbors and Ping.

- [Allow guests to access your local network](#)

Tick this checkbox if you want to allow the wireless clients on your guest network to communicate with the devices connected to your router's LAN ports or main network via methods such as network neighbors and Ping.

4. Click [SAVE](#). Now you can ensure network security and privacy!

## Chapter 8

---

# USB Settings

---

This chapter describes how to use the USB ports to share files and media from the USB storage devices over your home network locally, or remotely through the internet.

The router supports USB external flash drives and hard drives.

It contains the following sections:

- [Access the USB Storage Device](#)
- [Media Sharing](#)
- [Time Machine](#)

## 8. 1. Access the USB Storage Device

Insert your USB storage device into the router's USB port and then access files stored there locally or remotely.

 **Tips:**

- If you use USB hubs, make sure no more than 4 devices are connected to the router.
- If the USB storage device requires using bundled external power, make sure the external power has been connected.
- If you use a USB hard drive, make sure its file system is FAT32, exFat, NTFS or HFS+.
- Before you physically disconnect a USB device from the router, safely remove it to avoid data damage: Go to [Advanced > USB > USB Storage Device](#) and click [Remove](#).

### 8. 1. 1. Access the USB Device Locally

Insert your USB storage device into the router's USB port and then refer to the following table to access files stored on your USB storage device.

#### Windows computer

- **Method 1:**

Go to [Computer > Network](#), then click the Network Server Name ([TP-SHARE](#) by default) in the [Computer](#) section.

 **Note:**

Operations in different systems are similar. Here we take Windows 7 as an example.

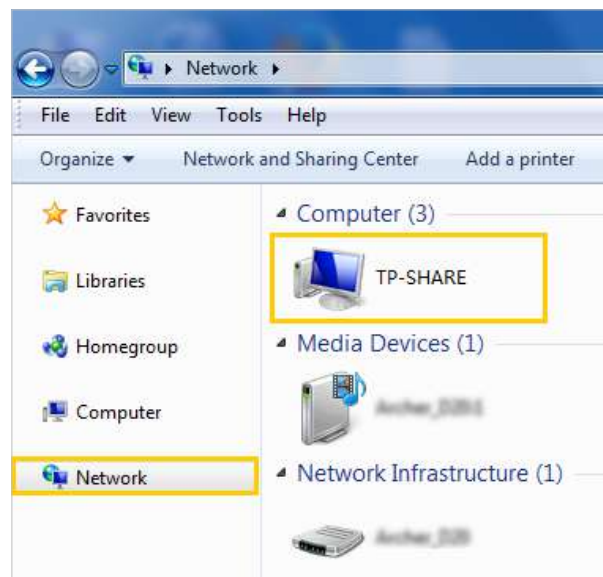

Windows  
computer

- **Method 2:**

Open the [Windows Explorer](#) (or go to [Computer](#)) and type the server address `\\tplinkwifi.net` or `ftp://tplinkwifi.net` in the address bar, then press [Enter](#).

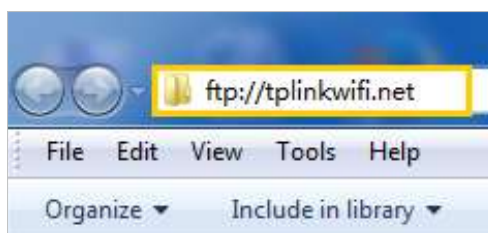

## Mac

- 1) Select [Go > Connect to Server](#).
- 2) Type the server address `smb://tplinkwifi.net`.
- 3) Click [Connect](#).



- 4) When prompted, select the [Guest](#) radio box. (If you have set up a username and a password to deny anonymous access to the USB disks, you should select the [Registered User](#) radio box. To learn how to set up an account for the access, refer to [To Set Up Authentication for Data Security](#).)

## Tablet

Use a third-party app for network files management.

 **Tips:**

You can also access your USB storage device by using your Network/Media Server Name as the server address. Refer to [To Customize the Address of the USB Storage Device](#) to learn more.

## 8. 1. 2. Access the USB Device Remotely

You can access your USB disk outside the local area network. For example, you can:

- Share photos and other large files with your friends without logging in to (and paying for) a photo-sharing site or email system.
- Get a safe backup for the materials for a presentation.
- Remove the files on your camera's memory card from time to time during the journey.

**Note:**

If your ISP assigns a private WAN IP address (such as 192.168.x.x or 10.x.x.x), you cannot use this feature because private addresses are not routed on the internet.

Follow the steps below to configure remote access settings.

1. Visit <http://tplinkwifi.net>, and log in with your TP-Link ID or the password you set for the router.
2. Go to **Advanced > USB > USB Storage Device**.
3. Tick the **Internet FTP** checkbox, and then click **SAVE**.

**Access Method**

Select the method for accessing your USB storage device. The device can then be reached via the access address.

Network/Media Server Name:

Enable	Access Method	Address	Port
<input checked="" type="checkbox"/>	Samba for Windows	\\TP-Share	---
<input checked="" type="checkbox"/>	Local FTP	ftp://192.168.0.1:21	21
<input checked="" type="checkbox"/>	Internet FTP	ftp://0.0.0.0:21 <a href="#">Set DDNS</a>	<input type="text" value="21"/>

4. Refer to the following table to access your USB disk remotely.

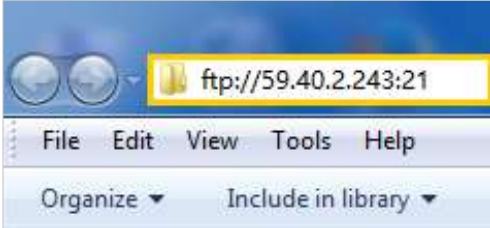
Computer	<ol style="list-style-type: none"> <li>1) Open the <a href="#">Windows Explorer</a> (or go to <a href="#">Computer</a>, only for Windows users) or open a web browser.</li> <li>2) Type the server address in the address bar: Type in <a href="#">ftp://&lt;WAN IP address of the router&gt;:&lt;port number&gt;</a> (such as <a href="#">ftp://59.40.2.243:21</a>). If you have specified the domain name of the router, you can also type in <a href="#">ftp://&lt;domain name&gt;:&lt;port number&gt;</a> (such as <a href="#">ftp://MyDomainName:21</a>)</li> </ol> <div data-bbox="644 527 1134 753" style="text-align: center;">  </div> <ol style="list-style-type: none"> <li>3) Press <a href="#">Enter</a> on the keyboard.</li> <li>4) Access with the username and password you set in <a href="#">To Set Up Authentication for Data Security</a>.</li> </ol> <p><b>Tips:</b> You can also access the USB disk via a third-party app for network files management, which can resume broken file transfers.</p>
	Tablet

**Tips:**

Click [Set Up a Dynamic DNS Service Account](#) to learn how to set up a domain name for you router.

### 8.1.3. Customize the Access Settings

By default, all the network clients can access all folders on your USB disk. You can customize your sharing settings by setting a sharing account, sharing specific contents and setting a new sharing address on the router's web management page.

1. Visit <http://tplinkwifi.net>, and log in with your TP-Link ID or the password you set for the router.
2. Go to [Advanced](#) > [USB](#) > [USB Storage Device](#).

- **To Customize the Address of the USB Storage Device**

You can customize the server name and use the name to access your USB storage device.

1. In the [Access Method](#) session, make sure [Samba for Windows](#) is ticked, and enter a [Network/Media Server Name](#) as you like, such as [MyShare](#), then click [SAVE](#).

**Access Method**

Select the method for accessing your USB storage device. The device can then be reached via the access address.

Network/Media Server Name:

Enable	Access Method	Address	Port
<input checked="" type="checkbox"/>	Samba for Windows	\\TP-Share	---
<input checked="" type="checkbox"/>	Local FTP	ftp://192.168.0.1:21	21
<input type="checkbox"/>	Internet FTP	ftp://0.0.0.0:21 <a href="#">Set DDNS</a>	<input type="text" value="21"/>

2. Now you can access the USB storage device by visiting <\\MyShare> (for Windows) or <smb://MyShare> (for Mac).

- **To Only Share Specific Content**

Focus on the [File Sharing](#) section. Specify sharing folders that you want to share and click [SAVE](#).

Sharing Contents:

Share Selected Folders:

G:/Document

G:/Pictures

- **To Set Up Authentication for Data Security**

You can set up authentication for your USB storage device so that network clients will be required to enter username and password when accessing the USB storage device.

1. In the [File Sharing](#) section, enable [Secure Sharing](#).

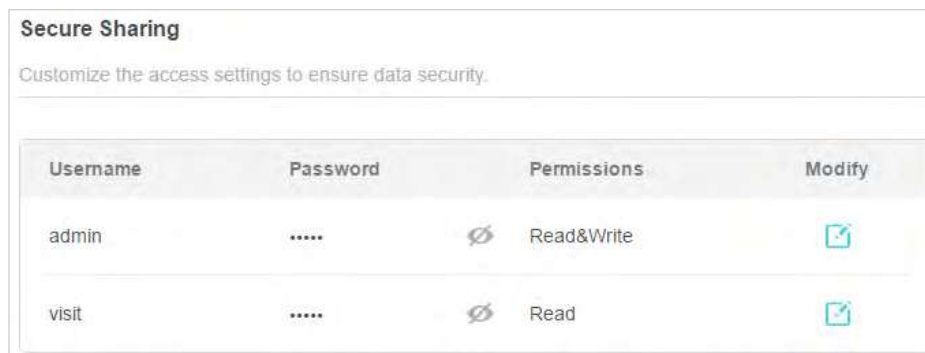

- Click to modify the access account. The username and password are both **admin** for default administrator account, and both **visit** for default visitor account. Accessing as an administrator can read and modify the shared folders while visitors can only read the shared folders.

**Note:**

- For Windows users, do not set the sharing username the same as the Windows username. Otherwise, Windows credential mechanism may cause the following problems:
  - If the sharing password is also the same as the Windows password, authentication will not work since the Windows will automatically use its account information for USB access.
  - If the sharing password is different from the Windows password, the Windows will be unable to remember your credentials and you will always be required to enter the sharing password for USB access.
- Due to Windows credential mechanism, you might be unable to access the USB disk after changing Authentication settings. Please log out from the Windows and try to access again. Or you can change the address of the USB disk by referring to [To Customize the Address of the USB Storage Device](#).

## 8.2. Media Sharing

The feature of **Media Sharing** allows you to view photos, play music and watch movies stored on the USB storage device directly from DLNA-supported devices, such as your computer, tablet and PS2/3/4.

- Visit <http://tplinkwifi.net>, and log in with your TP-Link ID or the password you set for the router.
- Go to **Advanced > USB > USB Storage Device**.
- Enable **Media Sharing**.

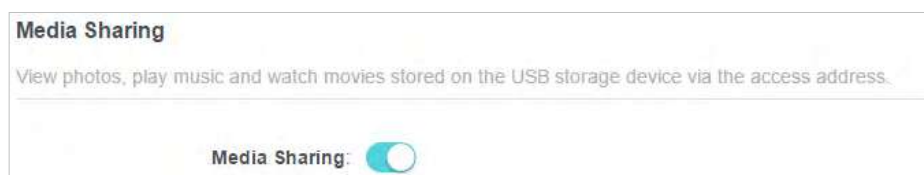

- When your USB storage device is inserted into the router, your DLNA-supported devices (such as your computer and pad) connected to the router can detect and play the media files on the USB storage devices.
- Refer to the following table for detailed instructions.

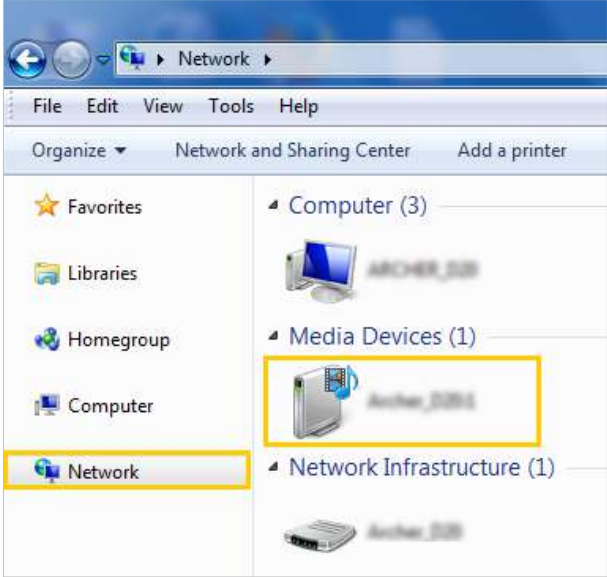

Windows Computer	<ul style="list-style-type: none"> <li>Go to <b>Computer &gt; Network</b>, then click the Media Server Name (<a href="#">Model number-share</a> by default) in the <b>Media Devices</b> section.</li> </ul> <p><b>Note:</b> Here we take Windows 7 as an example.</p>  <p>The screenshot shows a Windows 7 Network window. The left sidebar has 'Network' selected. The main pane shows a tree view with 'Computer (3)', 'Media Devices (1)', and 'Network Infrastructure (1)'. Under 'Media Devices (1)', a device icon is highlighted with a yellow box.</p>
Tablet	<ul style="list-style-type: none"> <li>Use a third-party DLNA-supported player.</li> </ul>

## 8.3. Time Machine

Time Machine backs up all files on your Mac computer to a USB storage device connected to your router.

- Visit <http://tplinkwifi.net>, and log in with your TP-Link ID or the password you set for the router.
- Go to **Advanced > USB > Time Machine**.

**Time Machine**

Back up all files on your Mac to a USB storage device connected to your router.

---

**Time Machine:**  Enable

Backup Location: ---

● Please select a location for Time Machine backups

SELECT

Storage Limit for Backups:  GB

(Enter "0" for no limit.)

3. Tick the checkbox to enable [Time Machine](#).
4. Click [Select](#) to select a location for Time Machine backups.
5. Set the [Size Limit for Backups](#).  
 **Note:** 0 means no limit for the space.
6. Click [SAVE](#).

## Chapter 9

---

# HomeShield

---

Customize your home network with enhanced security using a kit of features built in TP-Link HomeShield. Whether protecting your sensitive data or limiting the access of kids and guests, TP-Link HomeShield provides you the tools you need to fully manage your network.

It contains the following sections:

- [Network Security](#)
- [Parental Controls](#)
- [Network Analysis & Optimization](#)

## 9. 1. Network Security

TP-Link HomeShield provides many tools to protect your network from malicious attacks.



### Network Analysis

Analyze and optimize your network



### IoT Protection

Get real-time security for your Internet of Things



### Intrusion Prevention System

Identifies and block network intruders



### Malicious Content Filter

Block malicious content



### DDoS Protection

Protects your home network from DDoS attacks

- **To use this feature, download Tether to enjoy the HomeShield service**

1. Scan the QR code or get the Tether app from the Apple App Store or Google Play.



OR



2. Launch the Tether app and log in with your TP-Link ID. If you don't have an account, create one first.
3. Log in to your router and tap the HomeShield tab to use this feature.

## 9. 2. Parental Controls

Parental Controls allows you to set up unique restrictions on internet access for each member of your family. You can block inappropriate content, set daily limits for the total time spent online and restrict internet access to certain times of the day.



### Child Protection

Keep your child away from inappropriate content



### Family Incentive Program

Manage screen time and create rewards



### Family Time

Pause the internet to enjoy family time

- **To use this feature, download Tether to enjoy the HomeShield service**

1. Scan the QR code or get the Tether app from the Apple App Store or Google Play.



2. Launch the Tether app and log in with your TP-Link ID. If you don't have an account, create one first.

3. Log in to your router and tap the HomeShield tab to use this feature.

## 9.3. Network Analysis & Optimization

TP-Link HomeShield provides many tools for you to analyze and optimize your network.



### Weekly and Monthly Reports

Get weekly and monthly reports of your network usage



### Quality of Service (QoS)

Prioritizes devices to give faster performance



### Scan

Run a scan for a better network performance and security anytime

- **To use this feature, download Tether to enjoy the HomeShield service**

1. Scan the QR code or get the Tether app from the Apple App Store or Google Play.



2. Launch the Tether app and log in with your TP-Link ID. If you don't have an account, create one first.
3. Log in to your router and tap the HomeShield tab to use this feature.

## Chapter 10

---



# OneMesh with Seamless Roaming

---

This chapter introduces the TP-Link OneMesh™ feature.

It contains the following sections:

- [Set Up a OneMesh Network](#)
- [Manage Devices in the OneMesh Network](#)

TP-Link OneMesh  router and TP-Link OneMesh  extenders work together to form one unified Wi-Fi network. Walk through your home and stay connected with the fastest possible speeds thanks to OneMesh's seamless coverage.

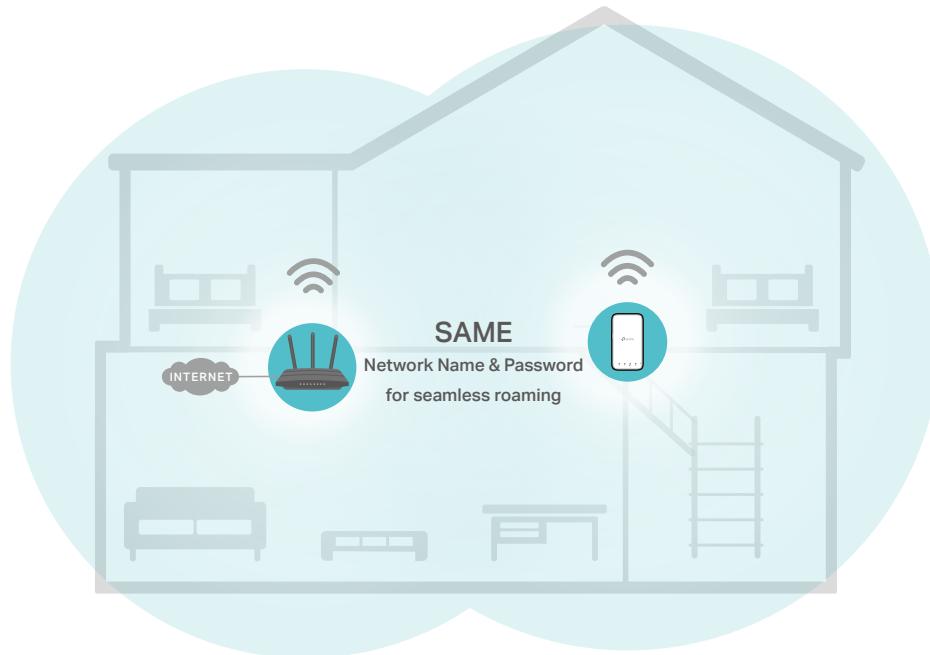

### Unified Wi-Fi Network

Router and extenders share the same wireless settings, including network name, password, access control settings and more.

### Seamless Roaming

Devices automatically switch between your router and extenders as you move through your home for the fastest possible speeds.

### Easy Setup and Management

Set up a OneMesh network with a push of WPS buttons. Manage all network devices on the Tether app or at your router's web management page.

## 10.1. Set Up a OneMesh Network

1. Visit <http://tplinkwifi.net>, and log in with your TP-Link ID or the password you set for the router.
2. Go to [Advanced > OneMesh](#).
3. Enable [OneMesh](#).



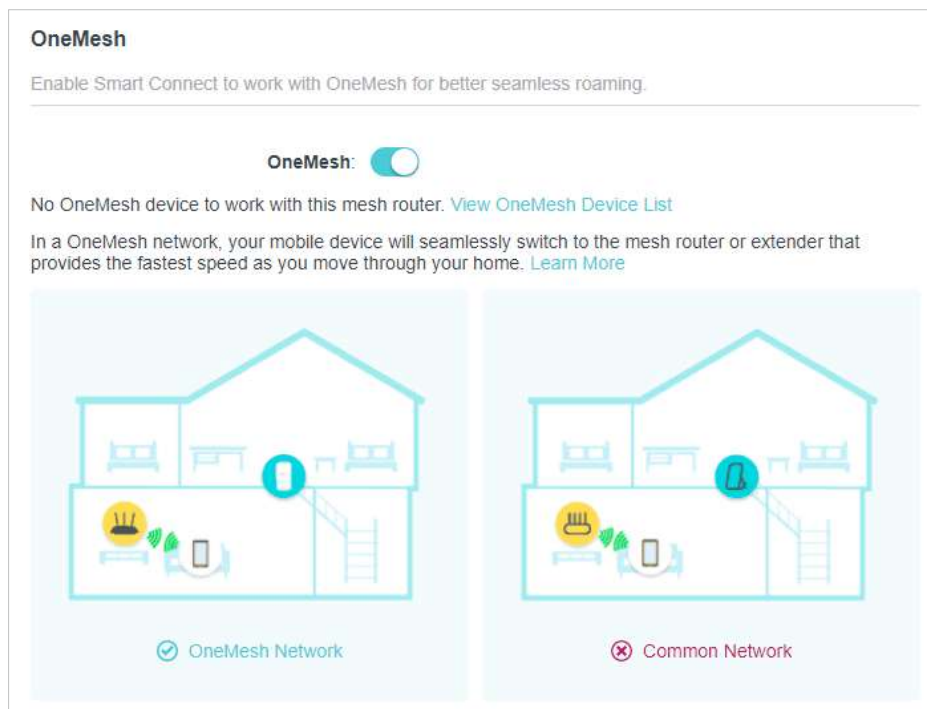

4. Connect a OneMesh extender to this router by following the setup instructions in the extender's manual. The extender will be listed on the router's [OneMesh](#) page.

▀ Note: To check full list of TP-Link OneMesh devices, visit <https://www.tp-link.com/onemesh/compatibility>.

5. If you have set up the extender to join the OneMesh network, it will be listed on the router's [OneMesh](#) page.



Otherwise, you need to find it in the [Available OneMesh Devices](#) list and click [Add](#) to add it to the OneMesh network.





**Done!** Now your router and extender successfully form a OneMesh network!

## 10.2. Manage Devices in the OneMesh Network

In a OneMesh network, you can manage all mesh devices and connected clients on your router's web page.

- **To view mesh devices and connected clients in the network:**

1. Visit <http://tplinkwifi.net>, and log in with your TP-Link ID or the password you set for the router.
2. Go to [Network Map](#).
3. Click  to view all mesh devices, and click  to view all connected clients.



- **To manage a OneMesh device in the network:**

1. Visit <http://tplinkwifi.net>, and log in with your TP-Link ID or the password you set for the router.
2. Go to [Advanced > OneMesh](#).



3. Click the OneMesh device to view detailed information.

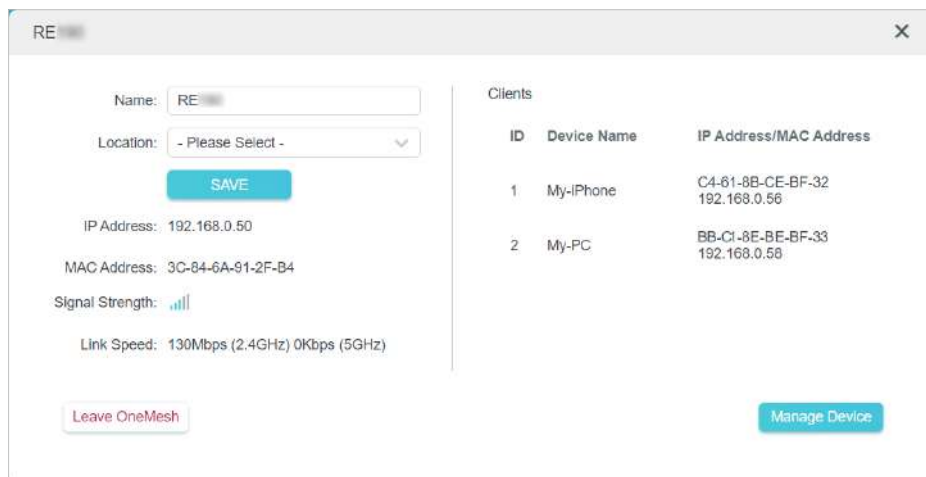

The screenshot shows a web interface for managing a OneMesh device. The device name is 'RE'. The location is set to '- Please Select -'. The IP address is 192.168.0.50, and the MAC address is 3C-84-6A-91-2F-B4. The signal strength is shown as a bar chart with four bars. The link speed is 130Mbps (2.4GHz) or 0Kbps (5GHz). There are two buttons: 'Leave OneMesh' and 'Manage Device'. A 'Clients' table is also visible, listing two devices: 'My-iPhone' and 'My-PC'.

ID	Device Name	IP Address/MAC Address
1	My-iPhone	C4-61-8B-CE-BF-32 192.168.0.56
2	My-PC	BB-C1-8E-BE-BF-33 192.168.0.58

#### 4. Manage the OneMesh device as needed. You can:

- Change device information.
- Click [Manage Device](#) to redirect to the web management page of this device.
- Click [Leave OneMesh](#) to delete this device from the OneMesh network.

## Chapter 11

---

# Network Security

---

This chapter guides you on how to protect your home network from cyber attacks and unauthorized users by implementing these three network security functions. You can protect your home network from cyber attacks, block or allow specific client devices to access your network using Access Control, or you can prevent ARP spoofing and ARP attacks using IP & MAC Binding.

It contains the following sections:

- [Protect the Network from Cyber Attacks](#)
- [Access Control](#)
- [IP & MAC Binding](#)

\*For a more comprehensive home network protection system, refer to the [HomeShield](#) chapter.

## 11.1. Protect the Network from Cyber Attacks

The SPI (Stateful Packet Inspection) Firewall protects the router from cyber attacks and validate the traffic that is passing through the router based on the protocol. This function is enabled by default.

1. Visit <http://tplinkwifi.net>, and log in with your TP-Link ID or the password you set for the router.
2. Go to [Advanced](#) > [Security](#) > [Firewall](#). It's recommended to keep the default settings.

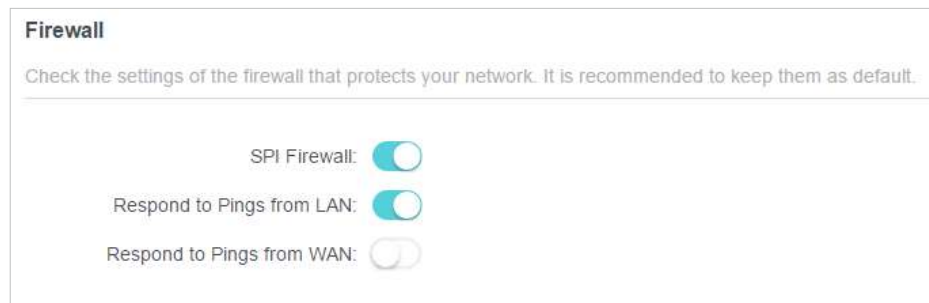

## 11.2. Access Control

Access Control is used to block or allow specific client devices to access your network (via wired or wireless) based on a list of blocked devices (Blacklist) or a list of allowed devices (Whitelist).

### I want to:

Block or allow specific client devices to access my network (via wired or wireless).

### How can I do that?

1. Visit <http://tplinkwifi.net>, and log in with your TP-Link ID or the password you set for the router.
2. Go to [Advanced](#) > [Security](#) > [Access Control](#).
3. Toggle on to enable [Access Control](#).
4. Select the access mode to either block (recommended) or allow the device(s) in the list.

#### To block specific device(s):

- 1) Select [Blacklist](#).

**Access Control**



Control the access to your network from the specified devices.

Access Control:

Access Mode:  Blacklist  
 Configure a blacklist to only block access to your network from the specified devices.

Whitelist

- 2) Click  **Add** and select devices you want to be blocked and Click **ADD**.
- 3) The **Operation Succeeded** message will appear on the screen, which means the selected devices have been successfully added to the blacklist.

Device Type	Device Name	MAC Address	Modify
	Yan	38-CA-DA-3A-D8-B1	

**To allow specific device(s):**

- 1) Select **Whitelist** and click **SAVE**.

**Access Control**

Control the access to your network from the specified devices.

Access Control:

Access Mode:  Blacklist  
 Whitelist  
 Configure a whitelist to only allow access to your network from the specified devices.

- 2) Your own device is in the whitelist by default and cannot be deleted. Click  **Add** to add other devices to the whitelist.

Device Type	Device Name	MAC Address	Modify
	UNKNOWN	00-19-66-35-E1-B0	

- **Add connected devices**

- 1) Click **Select From Device List**.
- 2) Select the devices you want to be allowed and click **ADD**.

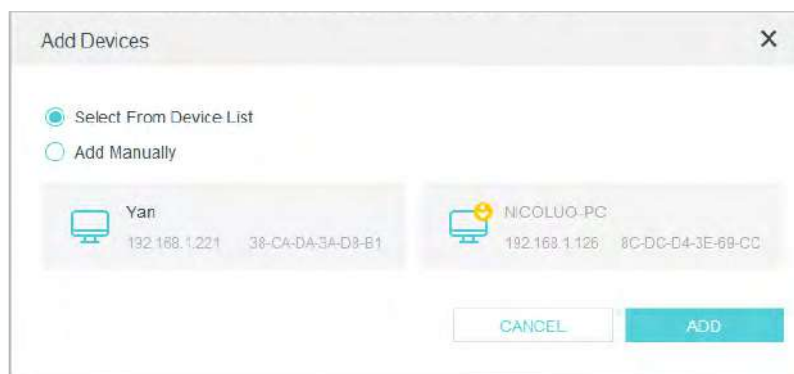

3) The **Operation Succeeded** message will appear on the screen, which means the selected devices have been successfully added to the whitelist.

- **Add unconnected devices**

1) Click **Add Manually**.

2) Enter the **Device Name** and **MAC Address** of the device you want to be allowed and click **ADD**.

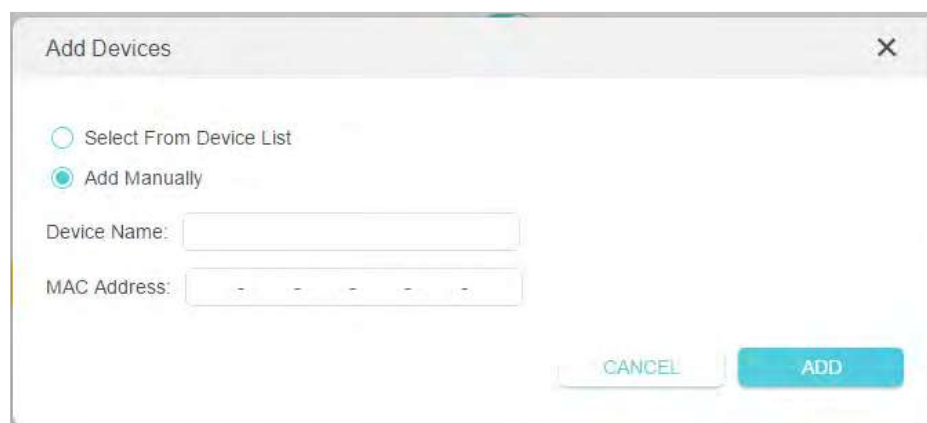

3) The **Operation Succeeded** message will appear on the screen, which means the device has been successfully added to the whitelist.

## Done!

Now you can block or allow specific client devices to access your network (via wired or wireless) using the **Blacklist** or **Whitelist**.

## 11.3. IP & MAC Binding

IP & MAC Binding, namely, ARP (Address Resolution Protocol) Binding, is used to bind network device's IP address to its MAC address. This will prevent ARP Spoofing and other ARP attacks by denying network access to an device with matching IP address in the Binding list, but unrecognized MAC address.

## I want to:

Prevent ARP spoofing and ARP attacks.

## How can I do that?

1. Visit <http://tplinkwifi.net>, and log in with your TP-Link ID or the password you set for the router.
2. Go to [Advanced](#) > [Security](#) > [IP & MAC Binding](#).
3. Enable [IP & MAC Binding](#).

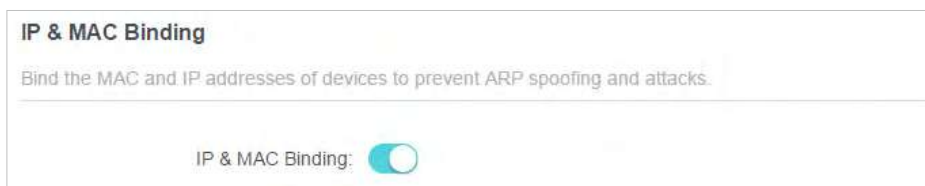

4. Bind your device(s) according to your need.

### To bind the connected device(s):

- 1) Click [+](#) [Add](#) in the [Binding List](#) section.



- 2) Click [VIEW CONNECTED DEVICES](#) and select the device you want to bind. The [MAC Address](#) and [IP Address](#) fields will be automatically filled in.

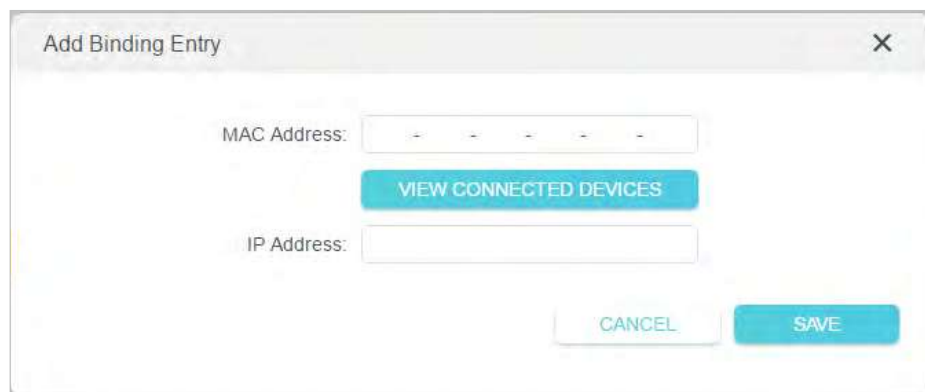

- 3) Click [SAVE](#).



**To bind the unconnected device:**

- 1) Click  Add in the [Binding List](#) section.



- 2) Enter the [MAC Address](#) and [IP Address](#) that you want to bind.
- 3) Click [SAVE](#).

**Done!**

Now you don't need to worry about ARP spoofing and ARP attacks!

## 11.4. ALG

ALG allows customized NAT traversal filters to be plugged into the gateway to support address and port translation for certain application layer "control/data" protocols such as FTP, TFTP, H323 etc. It is recommended to keep the default settings.

You may need to disable SIP ALG when you are using voice and video applications to create and accept a call through the router, since some voice and video communication applications do not work well with SIP ALG.

1. Visit <http://tplinkwifi.net>, and log in with your TP-Link ID or the password you set for the router.
2. Go to [Advanced](#) > [Security](#) > [ALG](#).

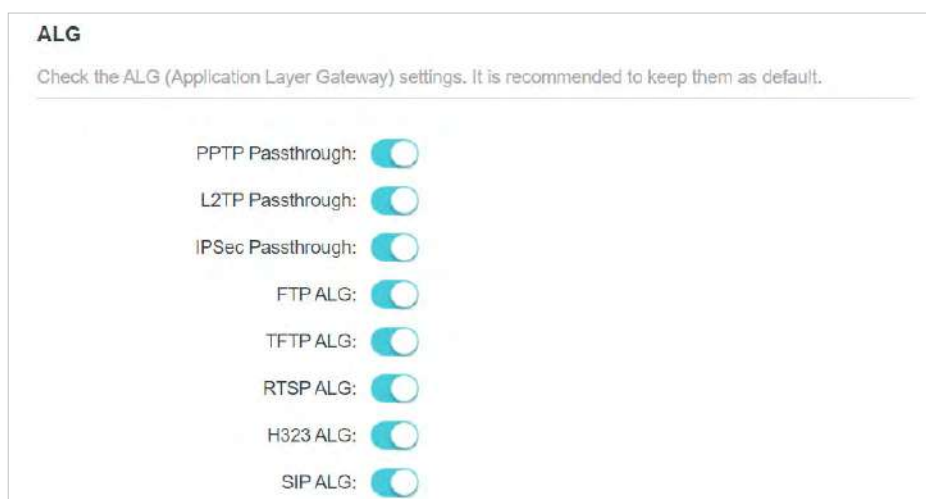

## Chapter 12

---

# NAT Forwarding

---

The router's NAT (Network Address Translation) feature makes devices on the LAN use the same public IP address to communicate with devices on the internet, which protects the local network by hiding IP addresses of the devices. However, it also brings about the problem that an external host cannot initiatively communicate with a specified device on the local network.

With the forwarding feature the router can penetrate the isolation of NAT and allows devices on the internet to initiatively communicate with devices on the local network, thus realizing some special functions.

The TP-Link router supports four forwarding rules. If two or more rules are set, the priority of implementation from high to low is Port Forwarding, Port Triggering, UPnP and DMZ.

It contains the following sections:

- [Share Local Resources on the Internet by Port Forwarding](#)
- [Open Ports Dynamically by Port Triggering](#)
- [Make Applications Free from Port Restriction by DMZ](#)
- [Make Xbox Online Games Run Smoothly by UPnP](#)

## 12.1. Share Local Resources on the Internet by Port Forwarding

When you build up a server on the local network and want to share it on the internet, Port Forwarding can realize the service and provide it to internet users. At the same time Port Forwarding can keep the local network safe as other services are still invisible from the internet.

Port Forwarding can be used for setting up public services on your local network, such as HTTP, FTP, DNS, POP3/SMTP and Telnet. Different services use different service ports. Port 80 is used in HTTP service, port 21 in FTP service, port 25 in SMTP service and port 110 in POP3 service. Please verify the service port number before the configuration.

### I want to:

Share my personal website I've built in local network with my friends through the internet.

**For example**, the personal website has been built on my home PC (192.168.0.100). I hope that my friends on the internet can visit my website in some way. The PC is connected to the router with the WAN IP address 218.18.232.154.

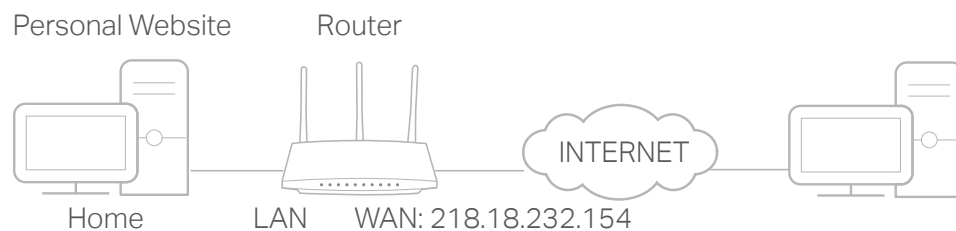

### How can I do that?

1. Assign a static IP address to your PC, for example 192.168.0.100.
2. Visit <http://tplinkwifi.net>, and log in with your TP-Link ID or the password you set for the router.
3. Go to **Advanced > NAT Forwarding > Port Forwarding**.
4. Click  **Add**.

**Port Forwarding**

Specify ports to make specific devices or services on your local network accessible over the internet.

[+ Add](#)

Service Name	Device IP Address	External Port	Internal Port	Protocol	Status	Modify
No Entries						

5. Click [VIEW COMMON SERVICES](#) and select [HTTP](#). The [External Port](#), [Internal Port](#) and [Protocol](#) will be automatically filled in.
6. Click [VIEW CONNECTED DEVICES](#) and select your home PC. The [Device IP Address](#) will be automatically filled in. Or enter the PC's IP address 192.168.0.100 manually in the [Device IP Address](#) field.
7. Click [SAVE](#).

**Add a Port Forwarding Entry** X

Service Name:

[VIEW COMMON SERVICES](#)

Device IP Address:

[VIEW CONNECTED DEVICES](#)

External Port:

Internal Port:

Protocol:  ▼

Enable This Entry

[CANCEL](#) [SAVE](#)

**Tips:**

- It is recommended to keep the default settings of [Internal Port](#) and [Protocol](#) if you are not clear about which port and protocol to use.
- If the service you want to use is not in the common services list, you can enter the corresponding parameters manually. You should verify the port number that the service needs.
- You can add multiple port forwarding rules if you want to provide several services in a router. Please note that the [External Port](#) should not be overlapped.

## Done!

Users on the internet can enter [http:// WAN IP](#) (in this example: [http:// 218.18.232.154](#)) to visit your personal website.

📌 **Tips:**

- The WAN IP should be a public IP address. For the WAN IP is assigned dynamically by the ISP, it is recommended to apply and register a domain name for the WAN referring to [Set Up a Dynamic DNS Service Account](#). Then users on the internet can use [http:// domain name](http://domain name) to visit the website.
- If you have changed the default **External Port**, you should use <http:// WAN IP: External Port> or <http:// domain name: External Port> to visit the website.

## 12.2. Open Ports Dynamically by Port Triggering

Port Triggering can specify a triggering port and its corresponding external ports. When a host on the local network initiates a connection to the triggering port, all the external ports will be opened for subsequent connections. The router can record the IP address of the host. When the data from the internet return to the external ports, the router can forward them to the corresponding host. Port Triggering is mainly applied to online games, VoIPs, video players and common applications including MSN Gaming Zone, Dialpad and Quick Time 4 players, etc.

Follow the steps below to configure the Port Triggering rules:

1. Visit <http://tplinkwifi.net>, and log in with your TP-Link ID or the password you set for the router.
2. Go to [Advanced](#) > [NAT Forwarding](#) > [Port Triggering](#) and click [+ Add](#).

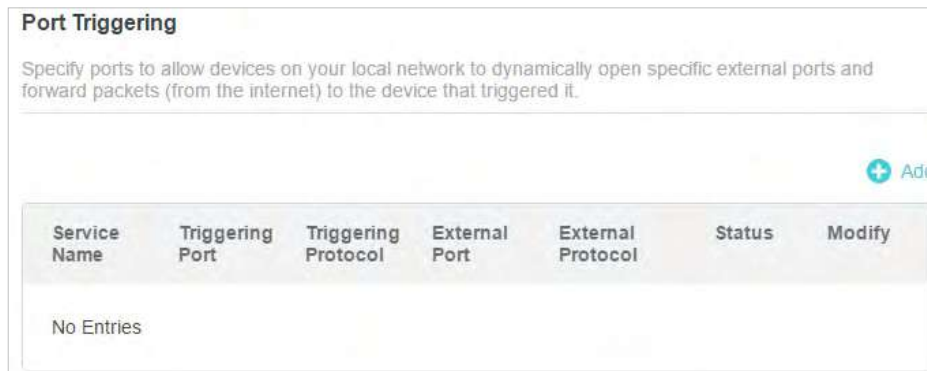

3. Click [VIEW COMMON SERVICES](#), and select the desired application. The **Triggering Port**, **Triggering Protocol** and **External Port** will be automatically filled in. The following picture takes application [MSN Gaming Zone](#) as an example.

#### 4. Click **SAVE**.

##### Tips:

- You can add multiple port triggering rules according to your network need.
- The triggering ports can not be overlapped.
- If the application you need is not listed in the Existing Applications list, please enter the parameters manually. You should verify the external ports the application uses first and enter them into [External Port](#) field according to the format the page displays.

## 12.3. Make Applications Free from Port Restriction by DMZ

When a PC is set to be a DMZ (Demilitarized Zone) host on the local network, it is totally exposed to the internet, which can realize the unlimited bidirectional communication between internal hosts and external hosts. The DMZ host becomes a virtual server with all ports opened. When you are not clear about which ports to open in some special applications, such as IP camera and database software, you can set the PC to be a DMZ host.

##### Note:

When DMZ is enabled, the DMZ host is totally exposed to the internet, which may bring some potential safety hazards. If DMZ is not in use, please disable it in time.

### I want to:

Make the home PC join the internet online game without port restriction.

**For example**, due to some port restriction, when playing the online games, you can log in normally but cannot join a team with other players. To solve this problem, set your PC as a DMZ host with all ports open.

## How can I do that?

1. Assign a static IP address to your PC, for example 192.168.0.100.
2. Visit <http://tplinkwifi.net>, and log in with your TP-Link ID or the password you set for the router.
3. Go to [Advanced](#) > [NAT Forwarding](#) > [DMZ](#) and tick to enable DMZ.
4. Click [VIEW CONNECTED DEVICES](#) and select your PC. The [Device IP Address](#) will be automatically filled in. Or enter the PC's IP address 192.168.0.100 manually in the [DMZ Host IP Address](#) field.



**DMZ**

Expose a specific device in your local network to the internet for applications such as online gaming and real-time communications.

DMZ:  Enable

DMZ Host IP Address:

[VIEW CONNECTED DEVICES](#)

5. Click [SAVE](#).

## Done!

The configuration is completed. You've set your PC to a DMZ host and now you can make a team to game with other players.

## 12.4. Make Xbox Online Games Run Smoothly by UPnP

The UPnP (Universal Plug and Play) protocol allows applications or host devices to automatically find the front-end NAT device and send request to it to open the corresponding ports. With UPnP enabled, the applications or host devices on the local network and the internet can freely communicate with each other thus realizing the seamless connection of the network. You may need to enable the UPnP if you want to use applications for multiplayer gaming, peer-to-peer connections, real-time communication (such as VoIP or telephone conference) or remote assistance, etc.

### ☞ Tips:

- UPnP is enabled by default in this router.
- Only the application supporting UPnP protocol can use this feature.
- UPnP feature needs the support of operating system (e.g. Windows Vista/ Windows 7/ Windows 8, etc. Some of operating system need to install the UPnP components).

[For example](#), when you connect your Xbox to the router which has connected to the internet to play online games, UPnP will send request to the router to open the

corresponding ports allowing the following data penetrating the NAT to transmit. Therefore, you can play Xbox online games without a hitch.

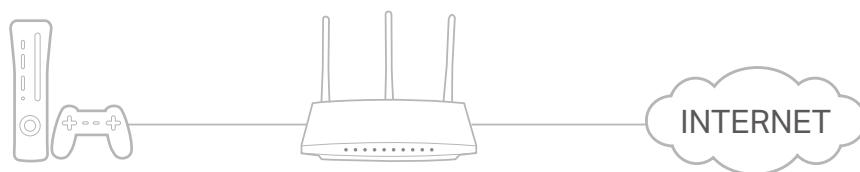

If necessary, you can follow the steps to change the status of UPnP.

1. Visit <http://tplinkwifi.net>, and log in with your TP-Link ID or the password you set for the router.
2. Go to **Advanced** > **NAT Forwarding** > **UPnP** and toggle on or off according to your needs.





## Chapter 13

---

# VPN Server&Client

---

The router offers several ways to set up VPN connections:

**VPN Server** allows remote devices to access your home network in a secured way through the internet. The router supports three types of VPN Server:

**OpenVPN** is somewhat complex but with higher security and more stability, suitable for restricted environments such as campus network and company intranet.

**PPTP VPN** is easy to use with the built-in VPN software of computers and mobile devices, but it is vulnerable and may be blocked by some ISPs.

**L2TP/IPSec VPN** is more secure but slower than PPTP VPN, and may have trouble getting around firewalls.

**VPN Client** allows devices in your home network to access remote VPN servers, without the need to install VPN software on each device.

This chapter contains the following sections:

- [Use OpenVPN to Access Your Home Network](#)
- [Use PPTP VPN to Access Your Home Network](#)
- [Use L2TP/IPSec VPN to Access Your Home Network](#)
- [Use VPN Client to Access a Remote VPN Server](#)

## 13.1. Use OpenVPN to Access Your Home Network

OpenVPN Server is used to create an OpenVPN connection for remote devices to access your home network.

To use the VPN feature, you need to enable OpenVPN Server on your router, and install and run VPN client software on remote devices. Please follow the steps below to set up an OpenVPN connection.

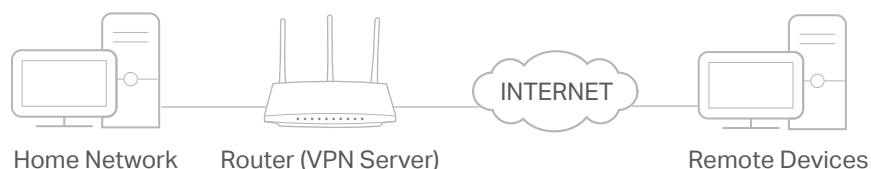

### Step1. Set up OpenVPN Server on Your Router

1. Visit <http://tplinkwifi.net>, and log in with your TP-Link ID or the password you set for the router.
2. Go to **Advanced > VPN Server > OpenVPN**, and tick the **Enable** box of **OpenVPN**.

**OpenVPN**

Set up an OpenVPN for secure, remote access to your network.

---

**Note:** No certificate has been created. Generate one below before enabling OpenVPN.

**OpenVPN:**  Enable

Service Type:  UDP  
 TCP

Service Port:

VPN Subnet:

Netmask:

Client Access:  ▼

**Note:**

- Before you enable VPN Server, we recommend you configure Dynamic DNS Service (recommended) or assign a static IP address for router's WAN port and synchronize your System Time with internet.
- The first time you configure the OpenVPN Server, you may need to generate a certificate before you enable the VPN Server.

3. Select the **Service Type** (communication protocol) for OpenVPN Server: UDP, TCP.
4. Enter a VPN **Service Port** to which a VPN device connects, and the port number should be between 1024 and 65535.
5. In the **VPN Subnet/Netmask** fields, enter the range of IP addresses that can be leased to the device by the OpenVPN server.

6. Select your **Client Access** type. Select **Home Network Only** if you only want the remote device to access your home network; select **Internet and Home Network** if you also want the remote device to access internet through the VPN Server.
7. Click **SAVE**.
8. Click **GENERATE** to get a new certificate.

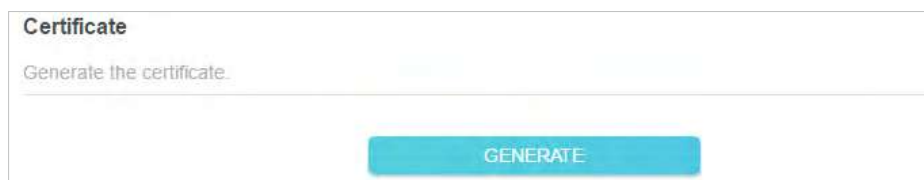

**Certificate**  
Generate the certificate.

**GENERATE**

**Note:** If you have already generated one, please skip this step, or click **GENERATE** to update the certificate.

9. Click **EXPORT** to save the OpenVPN configuration file which will be used by the remote device to access your router.



**Configuration File**  
Export the configuration file.

**EXPORT**

## Step 2. Configure OpenVPN Connection on Your Remote Device

1. Visit <http://openvpn.net/index.php/download/community-downloads.html> to download the OpenVPN software, and install it on your device where you want to run the OpenVPN client utility.

**Note:** You need to install the **OpenVPN** client utility on each device that you plan to apply the VPN function to access your router. Mobile devices should download a third-party app from Google Play or Apple App Store.

2. After the installation, copy the file exported from your router to the OpenVPN client utility's "config" folder (for example, **C:\Program Files\OpenVPN\config** on Windows). The path depends on where the OpenVPN client utility is installed.
3. Run the OpenVPN client utility and connect it to OpenVPN Server.

## 13. 2. Use PPTP VPN to Access Your Home Network

PPTP VPN Server is used to create a PPTP VPN connection for remote devices to access your home network.

To use the VPN feature, you need to set up PPTP VPN Server on your router, and configure the PPTP connection on remote devices. Please follow the steps below to set up a PPTP VPN connection.

### Step 1. Set up PPTP VPN Server on Your Router

1. Visit <http://tplinkwifi.net>, and log in with your TP-Link ID or the password you set for the router.
2. Go to [Advanced](#) > [VPN Server](#) > [PPTP](#), and tick the [Enable](#) box of [PPTP](#).

**PPTP**

Set up a PPTP VPN and accounts for quick, remote access to your network.

**PPTP:**  Enable

Client IP Address:  -   
(up to 10 clients)

Allow Samba (Network Place) access

Allow NetBIOS passthrough

Allow Unencrypted connections

**Note:** Before you enable [VPN Server](#), we recommend you configure Dynamic DNS Service (recommended) or assign a static IP address for router's WAN port and synchronize your [System Time](#) with internet.

3. In the [Client IP Address](#) field, enter the range of IP addresses (up to 10) that can be leased to the devices by the PPTP VPN server.
4. Set the PPTP connection permission according to your needs.
  - Select [Allow Samba \(Network Place\) access](#) to allow your VPN device to access your local Samba server.
  - Select [Allow NetBIOS passthrough](#) to allow your VPN device to access your Samba server using NetBIOS name.
  - Select [Allow Unencrypted connections](#) to allow unencrypted connections to your VPN server.
5. Click [SAVE](#).
6. Configure the PPTP VPN connection account for the remote device. You can create up to 16 accounts.

**Account List**

Configure accounts (up to 16) that can be used by remote clients to connect to the VPN server.

[+ Add](#)

Username	Password	Modify
admin	admin	<a href="#">Edit</a> <a href="#">Delete</a>

- 1) Click [Add](#).
- 2) Enter the [Username](#) and [Password](#) to authenticate devices to the PPTP VPN Server.

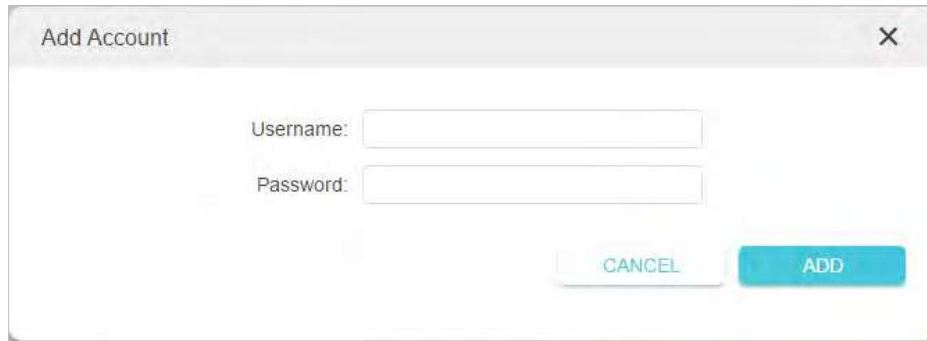

3) Click [ADD](#).

## Step 2. Configure PPTP VPN Connection on Your Remote Device

The remote device can use the Windows built-in PPTP software or a third-party PPTP software to connect to PPTP Server. Here we use the [Windows built-in PPTP software](#) as an example.

1. Go to [Start > Control Panel > Network and Internet > Network and Sharing Center](#).
2. Select [Set up a new connection or network](#).

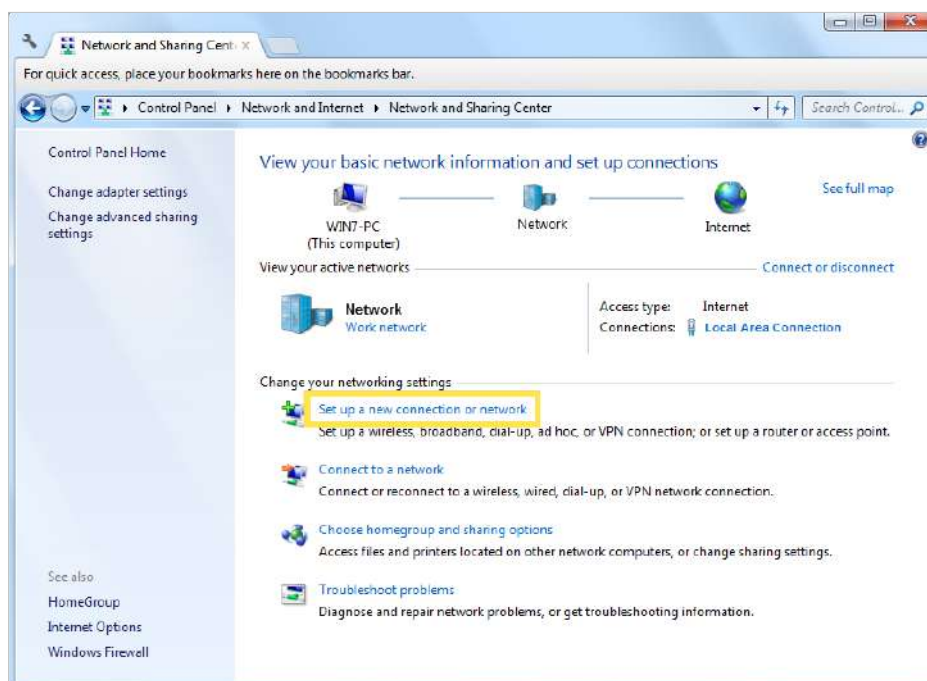

3. Select [Connect to a workplace](#) and click [Next](#).

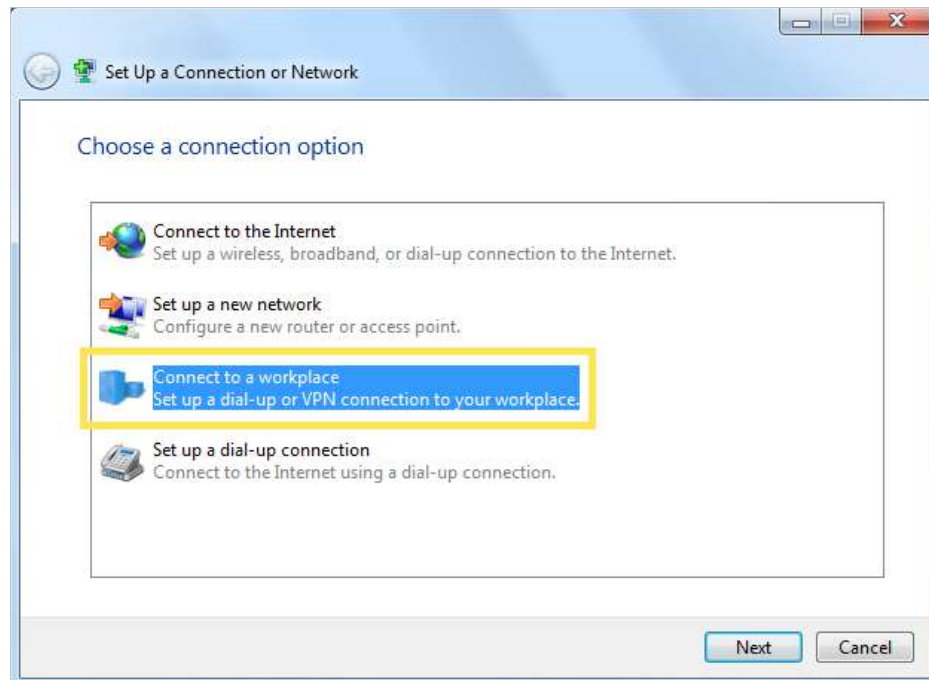

4. Select **Use my Internet connection (VPN)**.

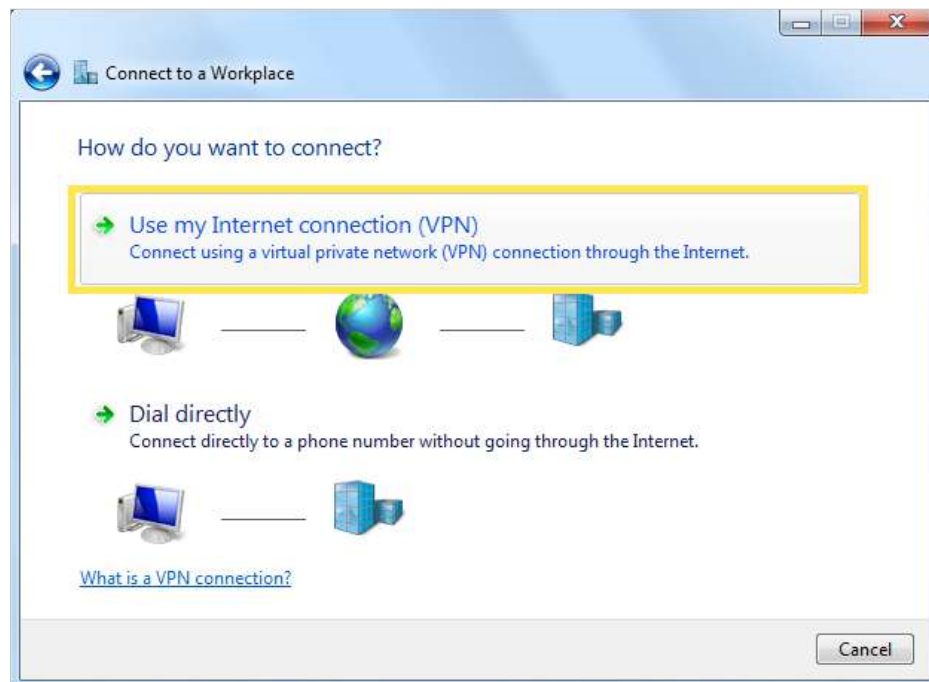

5. Enter the internet IP address of the router (for example: 218.18.1.73) in the **Internet address** field. Click **Next**.

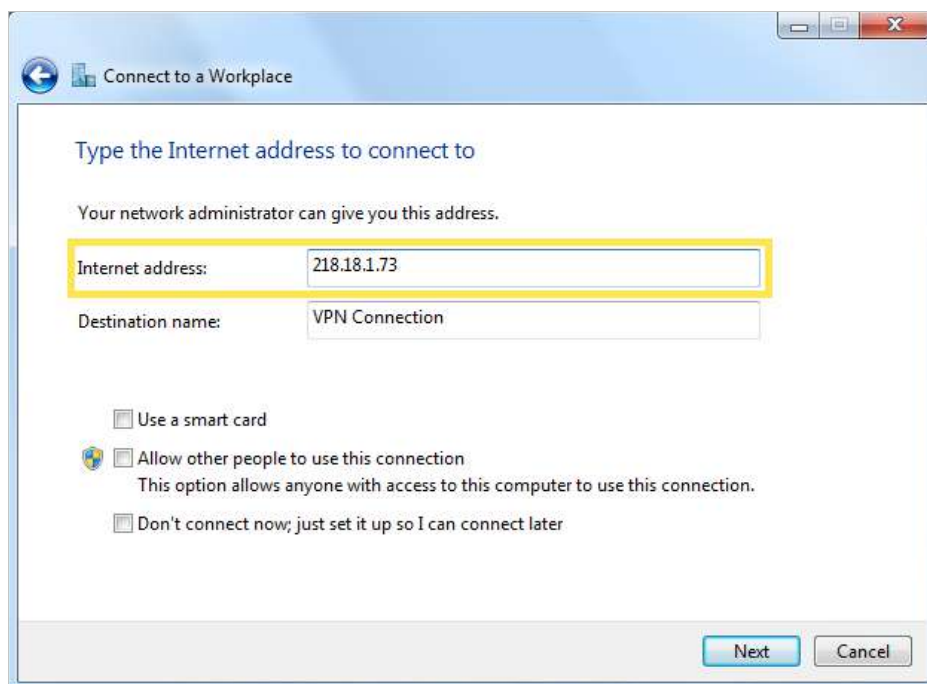

6. Enter the **User name** and **Password** you have set for the PPTP VPN server on your router, and click **Connect**.

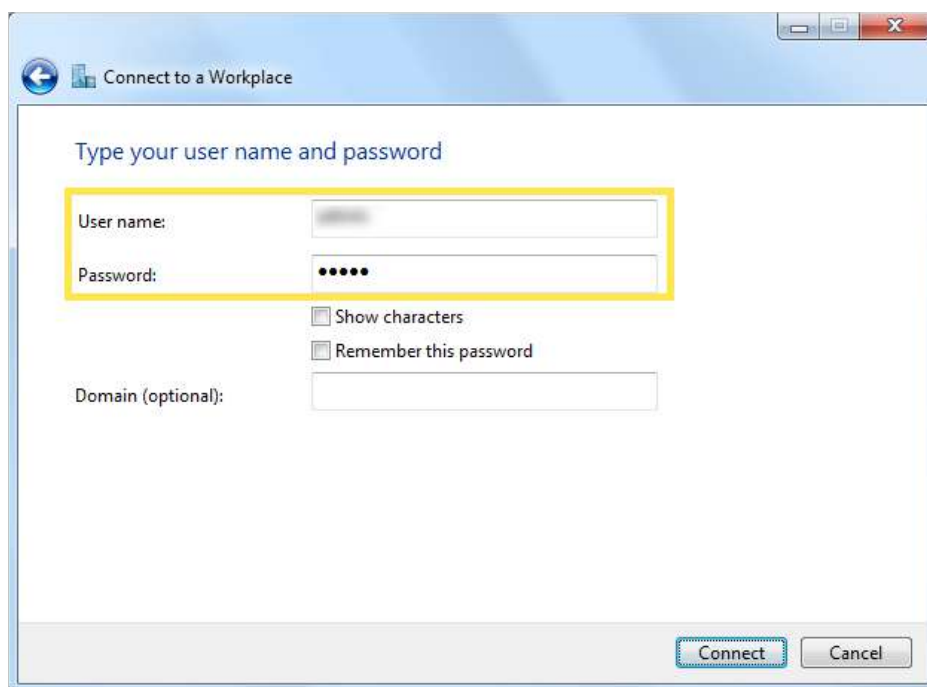

7. Click **Connect Now** when the VPN connection is ready to use.

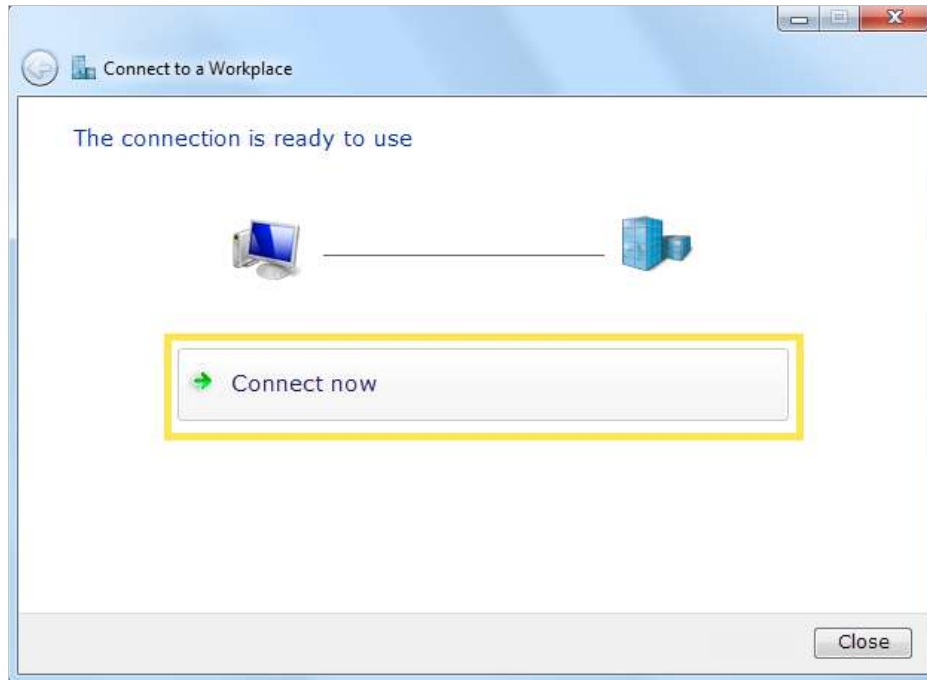

### 13.3. Use L2TP/IPSec VPN to Access Your Home Network

L2TP/IPSec VPN Server is used to create a L2TP/IPSec VPN connection for remote devices to access your home network.

To use the VPN feature, you need to set up L2TP/IPSec VPN Server on your router, and configure the L2TP/IPSec connection on remote devices. Please follow the steps below to set up the L2TP/IPSec VPN connection.

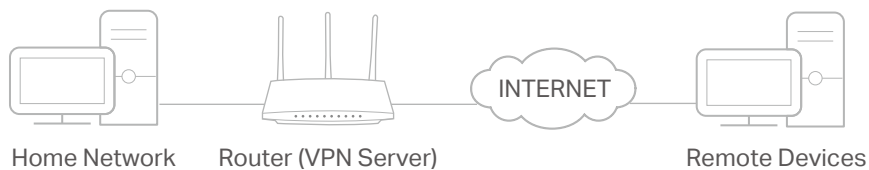

#### Step 1. Set up L2TP/IPSec VPN Server on Your Router

1. Visit <http://tplinkwifi.net>, and log in with your TP-Link ID or the password you set for the router.
2. Go to **Advanced > VPN Server > L2TP/IPSec**, and enable **L2TP/IPSec**.

**Note:**

- Firmware update may be required to support L2TP/IPSec VPN Server.
- Before you enable **VPN Server**, we recommend you configure **Dynamic DNS Service** (recommended) or assign a static IP address for router's WAN port and synchronize your **System Time** with internet.



**L2TP/IPSec**  
Set up a L2TP/IPSec VPN and accounts for quick, remote access to your network.

L2TP/IPSec:  Enable

Client IP Address:  -   
(up to 10 clients)

IPSec Encryption:

IPSec Pre-Shared Key:

3. In the **Client IP Address** field, enter the range of IP addresses (up to 10) that can be leased to the devices by the L2TP/IPSec VPN server.
4. Keep **IPSec Encryption** as **Encrypted** and create an **IPSec Pre-Shared Key**.
5. Click **SAVE**.
6. Configure the L2TP/IPSec VPN connection account for the remote device. You can create up to 16 accounts.

**Account List**  
Configure accounts (up to 16) that can be used by remote clients to connect to the VPN server.

[+ Add](#)

Username	Password	Modify
admin	admin	

- 4) Click **Add**.
- 5) Enter the **Username** and **Password** to authenticate devices to the L2TP/IPSec VPN Server.

**Add Account** X

Username:

Password:

- 6) Click **ADD**.

## Step 2. Configure L2TP/IPSec VPN Connection on Your Remote Device

The remote device can use the Windows or Mac OS built-in L2TP/IPSec software or a third-party L2TP/IPSec software to connect to L2TP/IPSec Server. Here we use the [Windows built-in L2TP/IPSec software](#) as an example.

1. Go to [Start > Control Panel > Network and Internet > Network and Sharing Center](#).
2. Select [Set up a new connection or network](#).

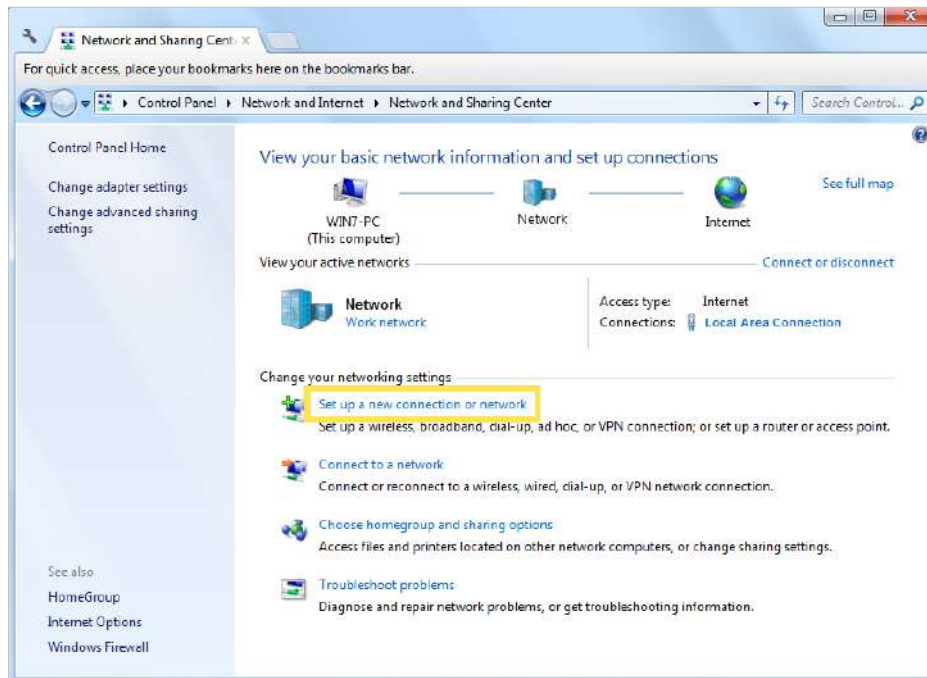

3. Select [Connect to a workplace](#) and click [Next](#).

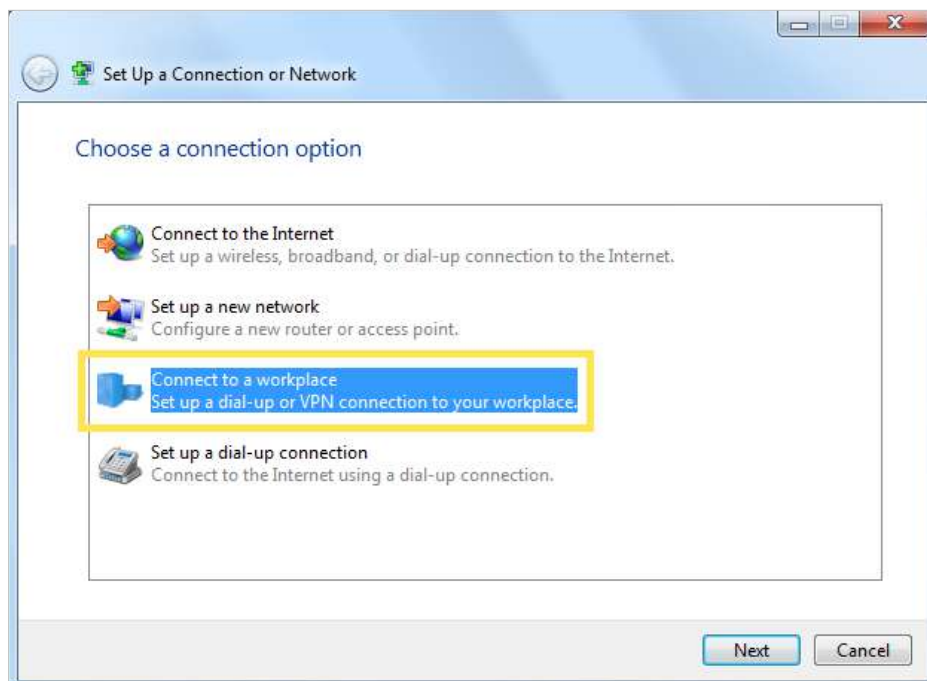

4. Select **Use my Internet connection (VPN)**.

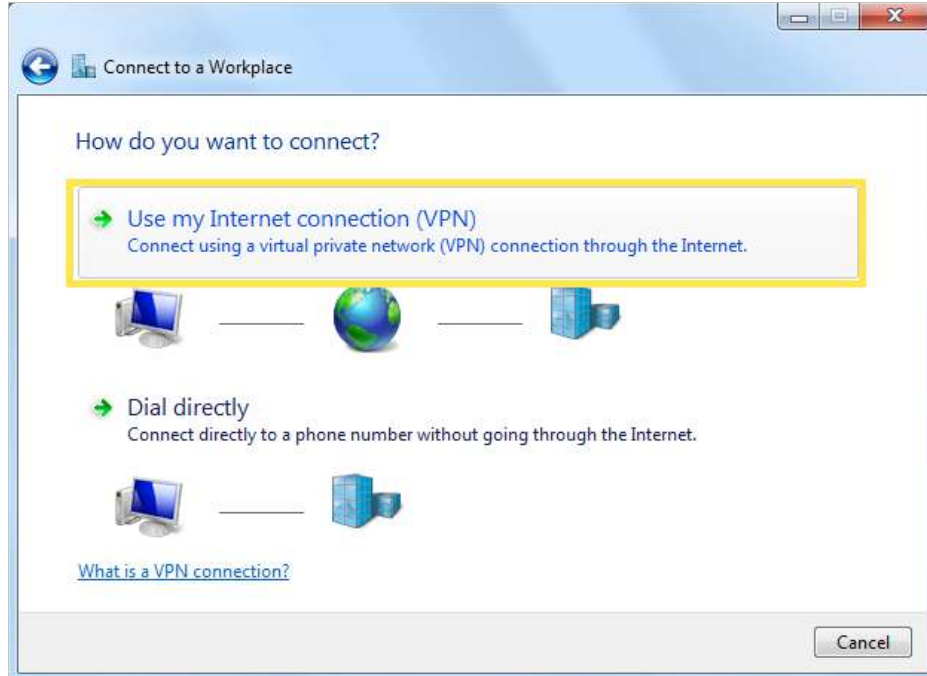

5. Enter the internet IP address of the router (for example: 218.18.1.73) in the **Internet address** field, and select the checkbox **Don't connect now; just set it up so I can connect later**. Click **Next**.

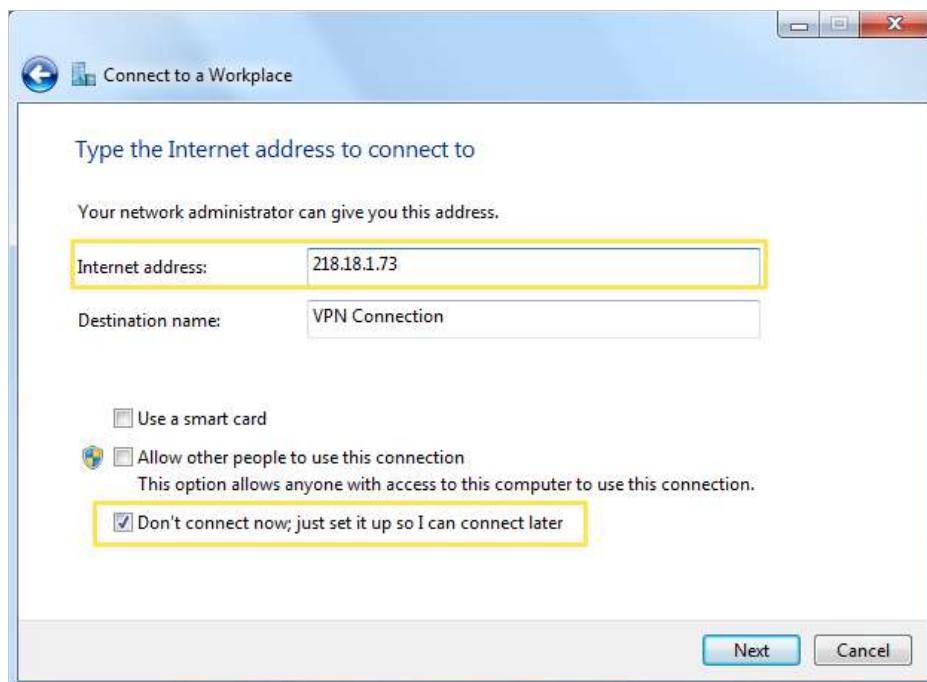

6. Enter the **User name** and **Password** you have set for the L2TP/IPSec VPN server on your router, and click **Connect**.

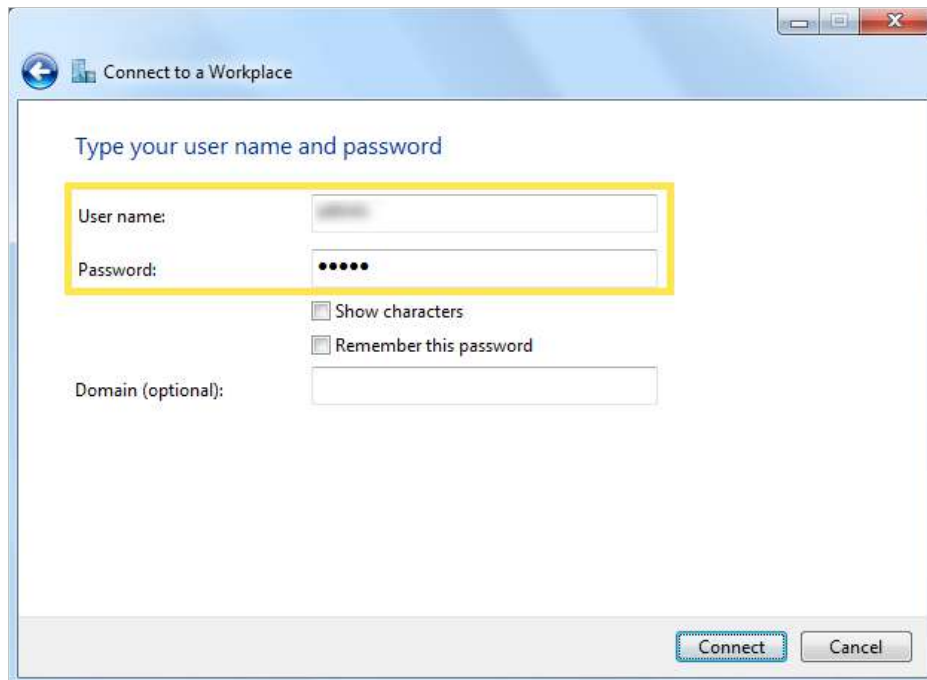

7. Click [Close](#) when the VPN connection is ready to use

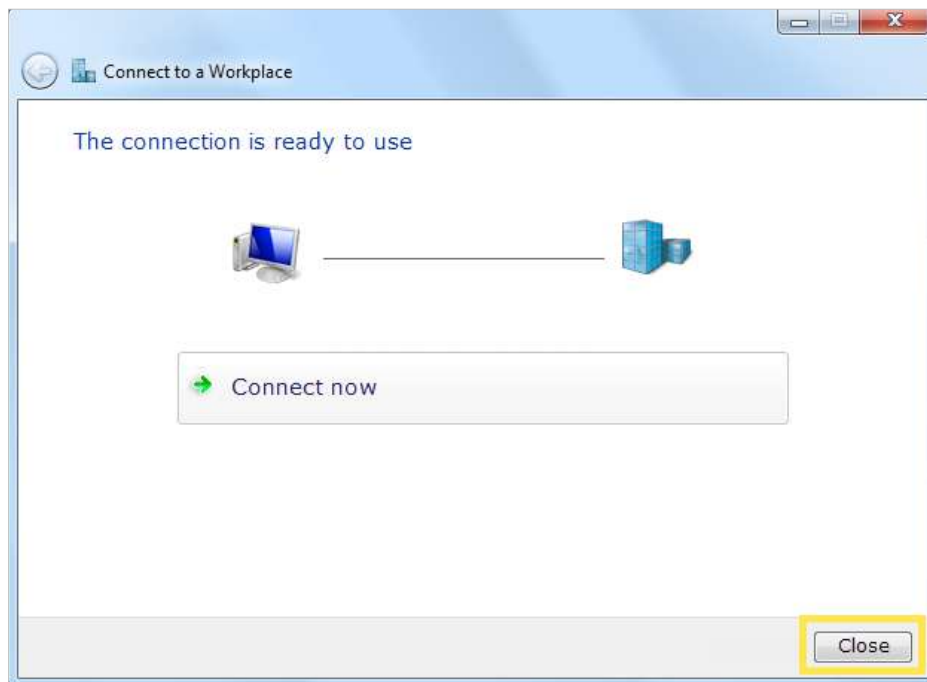

8. Go to [Network and Sharing Center](#) and click [Change adapter settings](#).

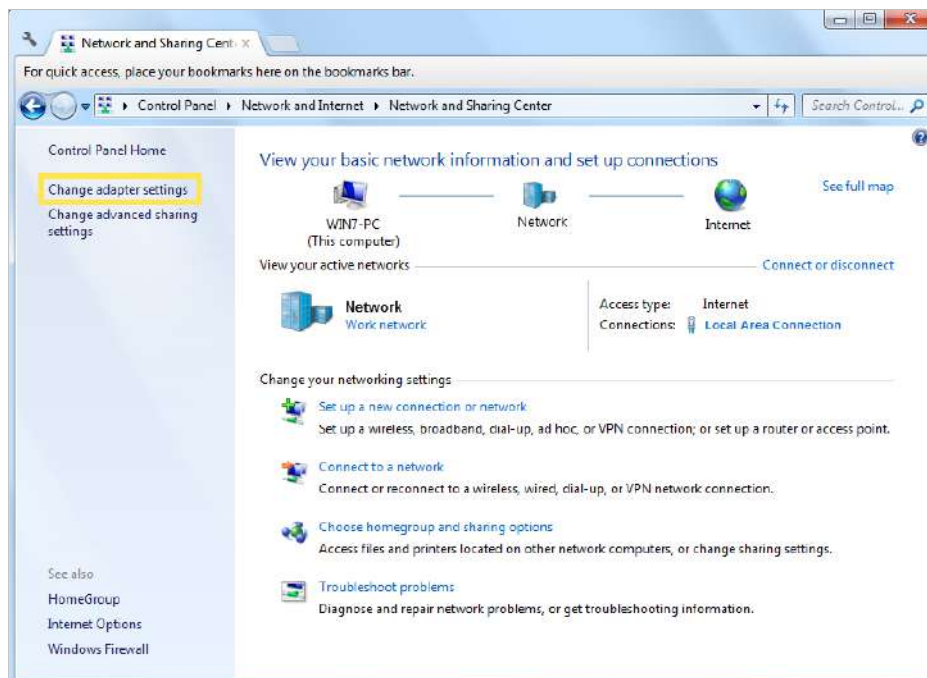

9. Find the VPN connection you created, then double-click it.

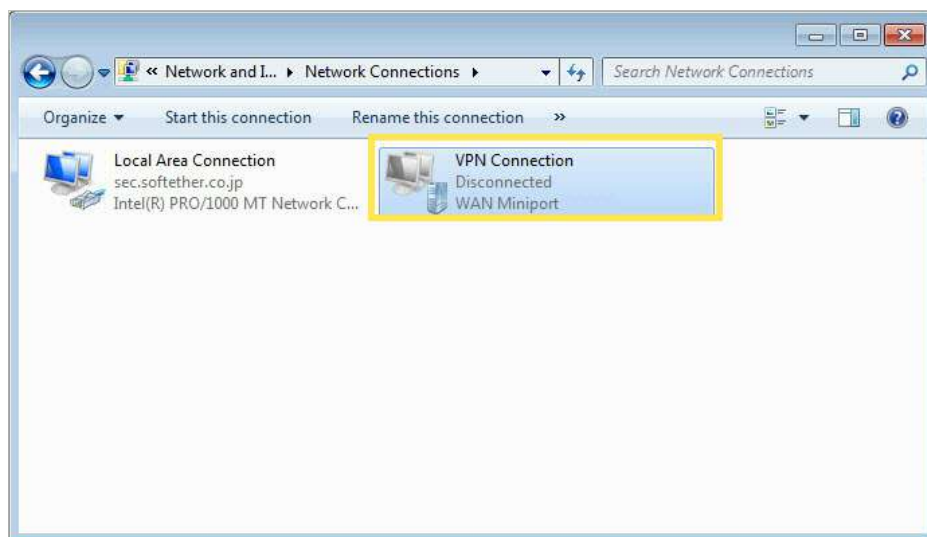

10. Enter the **User name** and **Password** you have set for the L2TP/IPSec VPN server on your router, and click **Properties**.



11. Switch to the **Security** tab, select **Layer 2 Tunneling Protocol with IPsec (L2TP/IPSec)** and click **Advanced settings**.

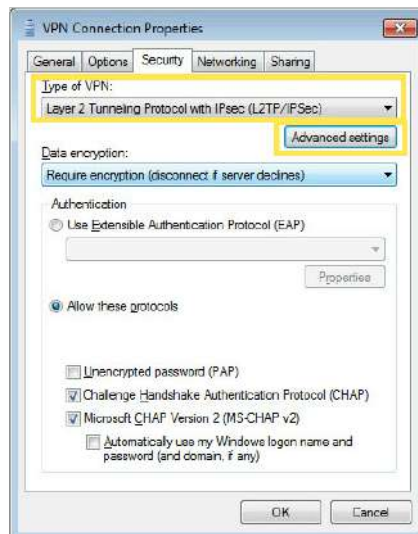

12. Select **Use preshared key for authentication** and enter the IPsec Pre-Shared Key you have set for the L2TP/IPsec VPN server on your router. Then click **OK**.

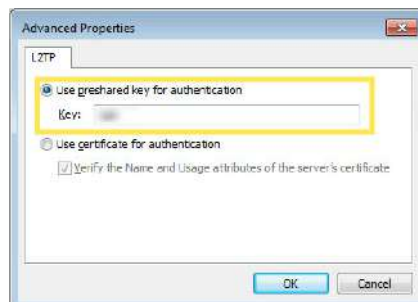

Done! Click **Connect** to start VPN connection.



## 13. 4. Use VPN Client to Access a Remote VPN Server

VPN Client is used to create VPN connections for devices in your home network to access a remote VPN server.

To use the VPN feature, simply configure a VPN connection and choose your desired devices on your router, then these devices can access the remote VPN server. Please follow the steps below:

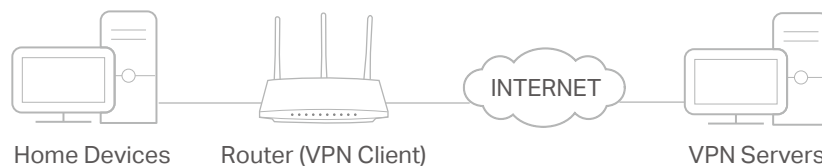

1. Visit <http://tplinkwifi.net>, and log in with your TP-Link ID or the password you set for the router.
  2. Go to **Advanced > VPN Client**.
- Note: Firmware update may be required to support VPN Client.
3. Enable **VPN Client**, then save the settings.



4. Add VPN servers, and enable the one you need.
  - 1) In the **Server List** section, click **Add**.
  - 2) Specify a description for the VPN, and choose the VPN type.

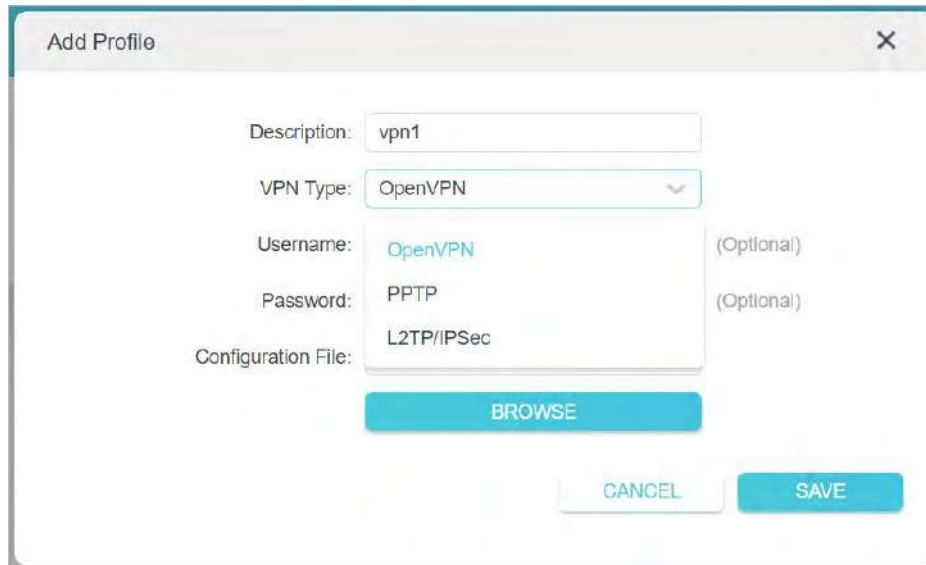

3) Enter the VPN information provided by your VPN provider.

- **OpenVPN:** Enter the VPN username and password if required by your VPN provider, otherwise simply leave them empty. Then import the configuration file provided by your VPN provider.

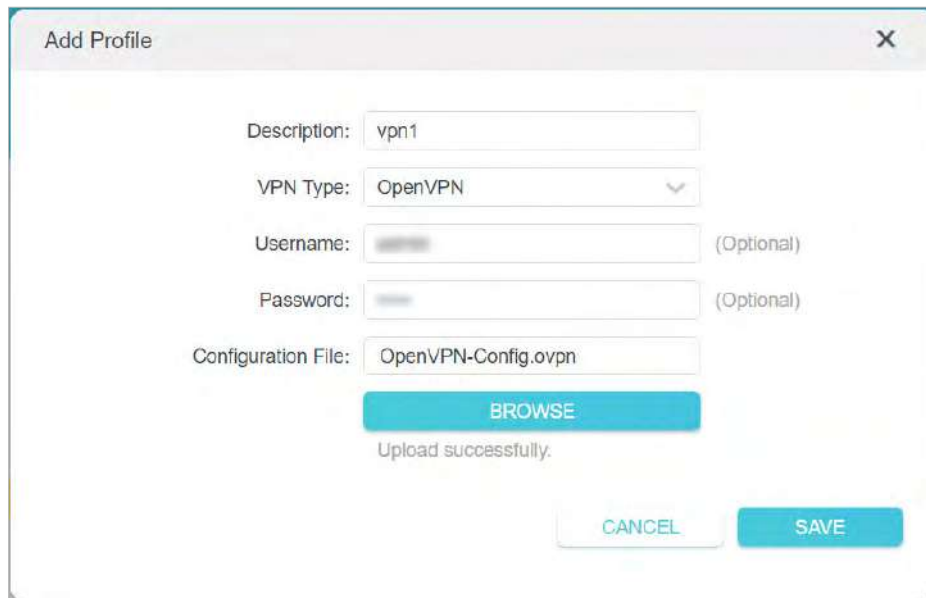

- **PPTP:** Enter the VPN server address (for example: 218.18.1.73) and the VPN username and password provided by your VPN provider.



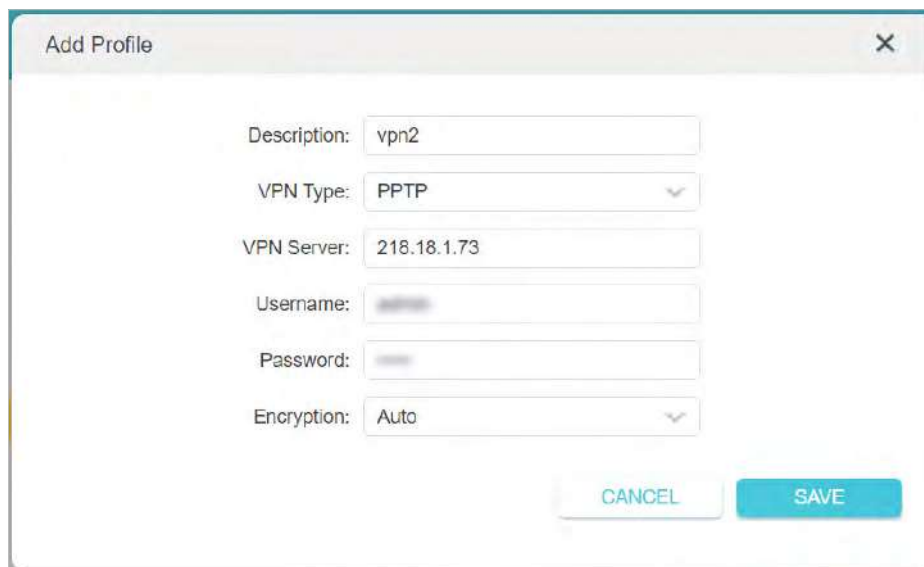

The screenshot shows a dialog box titled "Add Profile" with a close button (X) in the top right corner. The form contains the following fields:

- Description: vpn2
- VPN Type: PPTP (dropdown menu)
- VPN Server: 218.18.1.73
- Username: [blacked out]
- Password: [blacked out]
- Encryption: Auto (dropdown menu)

At the bottom right, there are two buttons: "CANCEL" and "SAVE".

- **L2TP/IPSec VPN:** Enter the VPN server address (for example: 218.18.1.73), VPN username and password, and IPSec pre-shared key provided by your VPN provider.

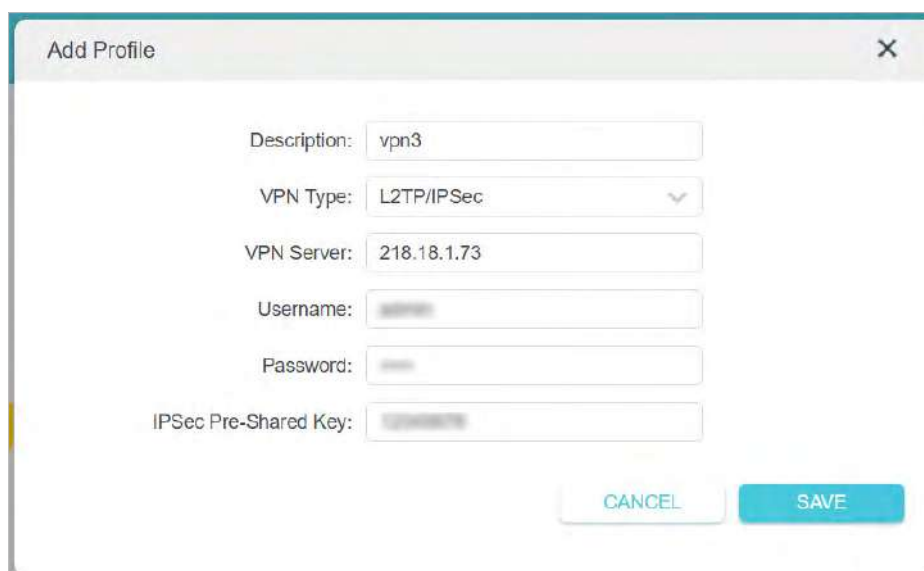

The screenshot shows a dialog box titled "Add Profile" with a close button (X) in the top right corner. The form contains the following fields:

- Description: vpn3
- VPN Type: L2TP/IPSec (dropdown menu)
- VPN Server: 218.18.1.73
- Username: [blacked out]
- Password: [blacked out]
- IPSec Pre-Shared Key: [blacked out]

At the bottom right, there are two buttons: "CANCEL" and "SAVE".

- 4) Save the settings.
- 5) In the server list, enable the one you need.

**Server List**

Add or edit VPN server. Up to 6 VPN servers can be added.

[+ Add](#)

Description	VPN Type	Status	ENABLE	Modify
vpn3	L2TP/IPSec	Disconnected	<input checked="" type="checkbox"/>	<a href="#">✎</a> <a href="#">🗑</a>
vpn2	PPTP	Disconnected	<input type="checkbox"/>	<a href="#">✎</a> <a href="#">🗑</a>
vpn1	OpenVPN	Disconnected	<input type="checkbox"/>	<a href="#">✎</a> <a href="#">🗑</a>

5. Add and manage the devices that will use the VPN function.

- 1) In the [Device List](#) section, click [Add](#).
- 2) Choose and add the devices that will access the VPN server you have configured.

Select the devices that will access VPN server.

Online Devices

<input type="checkbox"/>	Device Type	Device Name	MAC Address
<input checked="" type="checkbox"/>	...	...	FC-AA-14-55-FB-5D
<input checked="" type="checkbox"/>	...	...	86-D2-DE-B9-18-62

Offline Devices

<input type="checkbox"/>	Device Type	Device Name	MAC Address
No Entries			

[Cancel](#) [Add](#)

6. Save the settings.

**Device List**

Manage devices that will use the VPN function.

[+ Add](#)

Type	Device Name	MAC Address	VPN Access	Modify
	Android	FC:AA:14:55:FB:5D	<input checked="" type="checkbox"/>	
	iOS/iPhone	86:D2:DE:B9:18:62	<input checked="" type="checkbox"/>	

**Done!** Now the devices you specified can access the VPN server you enabled.

## Chapter 14

---

# Customize Your Network Settings

---

This chapter guides you on how to configure advanced network features.

It contains the following sections:

- [Change the LAN Settings](#)
- [Configure to Support IPTV Service](#)
- [Specify DHCP Server Settings](#)
- [Set Up a Dynamic DNS Service Account](#)
- [Create Static Routes](#)

## 14. 1. Change the LAN Settings

The router is preset with a default LAN IP 192.168.0.1, which you can use to log in to its web management page. The LAN IP address together with the Subnet Mask also defines the subnet that the connected devices are on. If the IP address conflicts with another device on your local network or your network requires a specific IP subnet, you can change it.

1. Visit <http://tplinkwifi.net>, and log in with your TP-Link ID or the password you set for the router.
2. Go to [Advanced](#) > [Network](#) > [LAN](#).
3. Type in a new IP Address appropriate to your needs. And leave the [Subnet Mask](#) as the default settings.



LAN

View and configure LAN settings:

MAC Address: 98-DA-C4-B4-01-D8

IP Address: 192.168.0.1

Subnet Mask: 255.255.255.0

4. Click [SAVE](#).

**Note:** If you have set the Port Forwarding, DMZ or DHCP address reservation, and the new LAN IP address is not in the same subnet with the old one, then you should reconfigure these features.

## 14. 2. Configure to Support IPTV Service

### I want to:

Configure IPTV setup to enable Internet/IPTV/Phone service provided by my internet service provider (ISP).

### How can I do that?

1. Visit <http://tplinkwifi.net>, and log in with your TP-Link ID or the password you set for the router.
2. Go to [Advanced](#) > [Network](#) > [IPTV/VLAN](#).
3. **If your ISP provides the networking service based on IGMP technology, e.g., British Telecom(BT) and Talk Talk in UK:**
  - 1) Tick the [IGMP Proxy](#) and [IGMP Snooping](#) checkbox, then select the [IGMP Version](#), either V2 or V3, as required by your ISP.

**Multicast**

Check the multicast settings. It is recommended to keep them as default.

IGMP Proxy:  Enable

IGMP Snooping:  Enable

IGMP Version: V2

- 2) Click [SAVE](#).
- 3) After configuring IGMP proxy, IPTV can work behind your router now. You can connect your set-top box to any of the router's Ethernet port.

**If IGMP is not the technology your ISP applies to provide IPTV service:**

- 1) Tick [Enable IPTV/VLAN](#).
- 2) Select the appropriate [Mode](#) according to your ISP.
  - Select [Bridge](#) if your ISP is not listed and no other parameters are required.
  - Select [Custom](#) if your ISP is not listed but provides necessary parameters.

**IPTV/VLAN**

Configure IPTV/VLAN settings if you want to enjoy IPTV or VoIP service, or if your ISP requires VLAN tags.

IPTV/VLAN:  Enable

Mode: Bridge

LAN1: Portugal-Meo

LAN2: Portugal-Vodafone

LAN3: Australia-NBN

LAN4: New Zealand-UFB

LAN4: Bridge

LAN4: Custom

- 3) After you have selected a mode, the necessary parameters, including the LAN port for IPTV connection, are predetermined. If not, select the LAN type to determine which port is used to support IPTV service.
- 4) Click [SAVE](#).
- 5) Connect the set-top box to the corresponding LAN port which is predetermined or you have specified in Step 3.

**Done!**

Your IPTV setup is done now! You may need to configure your set-top box before enjoying your TV.

## 14.3. Specify DHCP Server Settings

By default, the DHCP (Dynamic Host Configuration Protocol) Server is enabled and the router acts as a DHCP server; it dynamically assigns TCP/IP parameters to client devices from the IP Address Pool. You can change the settings of the DHCP Server if necessary, and you can reserve LAN IP addresses for specified client devices.

1. Visit <http://tplinkwifi.net>, and log in with your TP-Link ID or the password you set for the router.

2. Go to [Advanced](#) > [Network](#) > [DHCP Server](#).

- **To specify the IP address that the router assigns:**

1. Tick the [Enable](#) checkbox.

2. Enter the starting and ending IP addresses in the [IP Address Pool](#).

3. Enter other parameters if the ISP offers. The [Default Gateway](#) is automatically filled in and is the same as the LAN IP address of the router.

4. Click [SAVE](#).

- **To reserve an IP address for a specified client device:**

1. Click [Add](#) in the [Address Reservation](#) section.

2. Click [VIEW CONNECTED DEVICES](#) and select the you device you want to reserve an IP for. Then the [MAC Address](#) will be automatically filled in. Or enter the [MAC address](#) of the client device manually.
3. Enter the [IP address](#) to reserve for the client device.
4. Click [SAVE](#).

## 14.4. Set Up a Dynamic DNS Service Account

Most ISPs assign a dynamic IP address to the router and you can use this IP address to access your router remotely. However, the IP address can change from time to time and you don't know when it changes. In this case, you might apply the DDNS (Dynamic Domain Name Server) feature on the router to allow you and your friends to access your router and local servers (FTP, HTTP, etc.) using a domain name without checking and remembering the IP address.

**Note:** DDNS does not work if the ISP assigns a private WAN IP address (such as 192.168.1.x) to the router.

1. Visit <http://tplinkwifi.net>, and log in with your TP-Link ID or the password you set for the router.
2. Go to [Advanced](#) > [Network](#) > [Dynamic DNS](#).
3. Select the DDNS [Service Provider](#): TP-Link, NO-IP or DynDNS. It is recommended to select TP-Link so that you can enjoy TP-Link's superior DDNS service. Otherwise, please select NO-IP or DynDNS. If you don't have a DDNS account, you have to register first by clicking [Register Now](#).

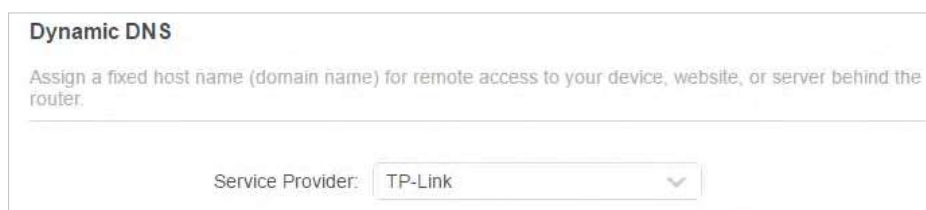

**Dynamic DNS**

Assign a fixed host name (domain name) for remote access to your device, website, or server behind the router.

---

Service Provider:

**Note:** To enjoy TP-Link's DDNS service, you have to log in with a TP-Link ID. If you have not logged in with one, click [log in](#).

4. Click [Register](#) in the [Domain Name List](#) if you have selected TP-Link, and enter the [Domain Name](#) as needed.



### Dynamic DNS

Assign a fixed host name (domain name) for remote access to your device, website, or server behind the router.

Service Provider: TP-Link

Current Domain Name:

#### Domain Name List

[+ Register](#)

Domain Name	Registered Date	Status	Operation	Delete
No Entries				

If you have selected NO-IP or DynDNS, enter the username, password and domain name of your account.

### Dynamic DNS

Assign a fixed host name (domain name) for remote access to your device, website, or server behind the router.

Service Provider: NO-IP [Register Now](#)

Username:

Password:

Domain Name:

WAN IP binding:  Enable

Status: Not launching

[LOGIN AND SAVE](#)

[LOGOUT](#)

5. Click [LOGIN AND SAVE](#).

 **Tips:** If you want to use a new DDNS account, please click [Logout](#) first, and then log in with a new account.

## 14.5. Create Static Routes

Static routing is a form of routing that is configured manually by a network administrator or a user by adding entries into a routing table. The manually-configured routing information guides the router in forwarding data packets to the specific destination.

## I want to:

Visit multiple networks and servers at the same time.

For example, in a small office, my PC can surf the internet through Router A, but I also want to visit my company's network. Now I have a switch and Router B. I connect the devices as shown in the following figure so that the physical connection between my PC and my company's server is established. To surf the internet and visit my company's network at the same time, I need to configure the static routing.

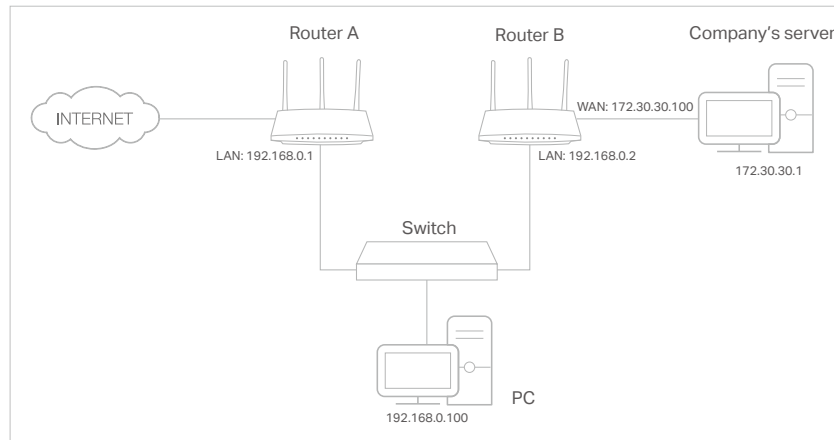

## How can I do that?

1. Change the routers' LAN IP addresses to two different IP addresses on the same subnet. Disable Router B's DHCP function.
2. Visit <http://tplinkwifi.net>, and log in with your TP-Link ID or the password you set for Router A.
3. Go to **Advanced > Network > Routing**.
4. Click **Add** and finish the settings according to the following explanations:

Add a Routing Entry
✕

Network Destination:

Subnet Mask:

Default Gateway:

Interface:  ▼

Description:

**Network Destination:** The destination IP address that you want to assign to a static route. This IP address cannot be on the same subnet with the WAN IP or LAN IP of Router A. In the example, the IP address of the company network is the destination IP address, so here enter 172.30.30.1.

**Subnet Mask:** Determines the destination network with the destination IP address. If the destination is a single IP address, enter 255.255.255.255; otherwise, enter the subnet mask of the corresponding network IP. In the example, the destination network is a single IP, so here enter 255.255.255.255.

**Default Gateway:** The IP address of the gateway device to which the data packets will be sent. This IP address must be on the same subnet with the router's IP which sends out data. In the example, the data packets will be sent to the LAN port of Router B and then to the Server, so the default gateway should be 192.168.0.2.

**Interface:** Determined by the port (WAN/LAN) that sends out data packets. In the example, the data are sent to the gateway through the LAN port of Router A, so **LAN/WLAN** should be selected.

**Description:** Enter a description for this static routing entry.

5. Click **SAVE**.
6. Check the **Routing Table** below. If you can find the entry you've set, the static routing is set successfully.

Routing Table			
View all valid routing entries that are currently in use.			
Active Route Number: 3			 Refresh
Network Destination	Subnet Mask	Gateway	Interface
172.30.30.1	255.255.255.255	192.168.0.2	LAN
192.168.0.0	255.255.255.0	0.0.0.0	LAN
0.0.0.0	0.0.0.0	0.0.0.0	WAN

**Done!**

Open a web browser on your PC. Enter the company server's IP address to visit the company network.

## Chapter 15

---

# Manage the Router

---

This chapter will show you the configuration for managing and maintaining your router.

It contains the following sections:

- [Update the Firmware](#)
- [Backup and Restore Configuration Settings](#)
- [Change the Login Password](#)
- [Password Recovery](#)
- [Local Management](#)
- [Remote Management](#)
- [System Log](#)
- [Test the Network Connectivity](#)
- [Set System Time and Language](#)
- [Set the Router to Reboot Regularly](#)
- [Control the LED](#)

## 15.1. Update the Firmware

TP-Link aims at providing better network experience for users.

We will inform you through the web management page if there's any new firmware available for your router. Also, the latest firmware will be released at the TP-Link official website [www.tp-link.com](http://www.tp-link.com), and you can download it from the [Support](#) page for free.

### Note:

- Back up your router's configurations before firmware update.
- Do NOT turn off the router during the firmware update.

### 15.1.1. Auto Update

1. Visit <http://tplinkwifi.net>, and log in with your TP-Link ID or the password you set for the router.
2. Go to [Advanced](#) > [System](#) > [Firmware Update](#).
3. Enable [Auto Update](#).

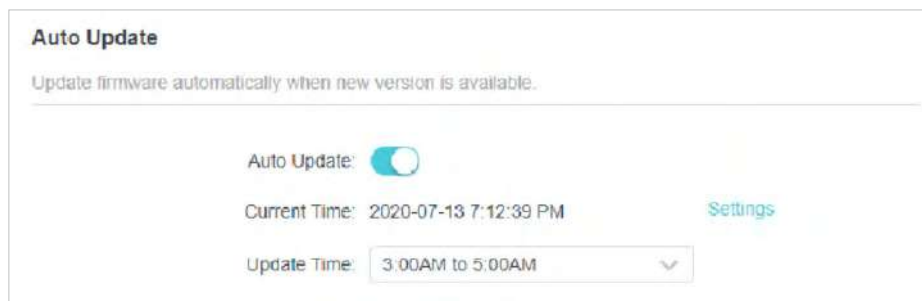

4. Specify the [Update Time](#) and save the settings.

The router will update firmware automatically at the specified time when new version is available.

### 15.1.2. Online Update

1. Visit <http://tplinkwifi.net>, and log in with your TP-Link ID or the password you set for the router.
2. When the latest firmware is available for your router, the update icon  will display in the top-right corner of the page. Click the icon to go to the [Firmware Update](#) page. Alternatively, you can go to [Advanced](#) > [System](#) > [Firmware Update](#), and click [CHECK FOR UPDATES](#) to see whether the latest firmware is released.

3. Focus on the **Online Update** section, and click **UPDATE** if there is new firmware.

4. Wait a few minutes for the update and reboot to complete.

**Tips:** If there's a new and important firmware update for your router, you will see the prompt notification on your computer as long as a web browser is opened. Click to update, and log in to the web management page with the username and password you set for the router. You will see the **Firmware Update** page.

### 15.1.3. Local Update

1. Download the latest firmware file for the router from [www.tp-link.com](http://www.tp-link.com).
2. Visit <http://tplinkwifi.net>, and log in with your TP-Link ID or the password you set for the router.
3. Go to **Advanced > System > Firmware Update**.
4. Focus on the **Local Update** section. Click **BROWSE** to locate the downloaded new firmware file, and click **UPDATE**.

5. Wait a few minutes for the update and reboot to complete.

**Note:** If you fail to update the firmware for the router, please contact our [Technical Support](#).

## 15.2. Backup and Restore Configuration Settings

The configuration settings are stored as a configuration file in the router. You can backup the configuration file to your computer for future use and restore the router to a previous settings from the backup file when needed. Moreover, if necessary you can erase the current settings and reset the router to the default factory settings.

1. Visit <http://tplinkwifi.net>, and log in with your TP-Link ID or the password you set for the router.

2. Go to [Advanced](#) > [System Tools](#) > [Backup & Restore](#).

- **To backup configuration settings:**

Click [BACK UP](#) to save a copy of the current settings to your local computer. A '.bin' file of the current settings will be stored to your computer.

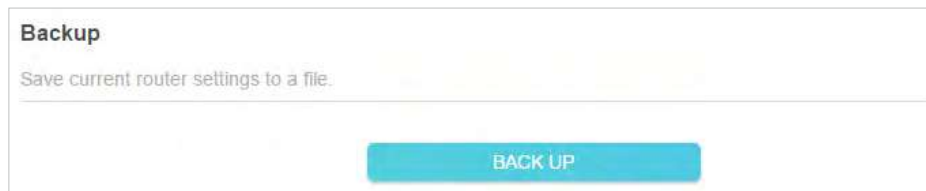

The screenshot shows a web interface titled "Backup". Below the title, there is a subtitle "Save current router settings to a file." and a large blue button labeled "BACK UP".

- **To restore configuration settings:**

1. Click [BROWSE](#) to locate the backup configuration file stored on your computer, and click [RESTORE](#).

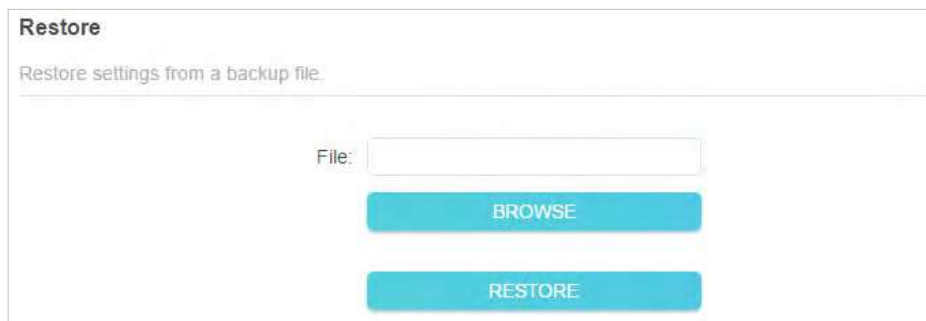

The screenshot shows a web interface titled "Restore". Below the title, there is a subtitle "Restore settings from a backup file." and a text input field labeled "File:". Below the input field are two blue buttons: "BROWSE" and "RESTORE".

2. Wait a few minutes for the restoring and rebooting.

**Note:** During the restoring process, do not turn off or reset the router.

- **To reset the router except your login password and TP-Link ID:**

1. In the [Factory Default Restore](#) section, click [RESTORE](#).

**Factory Default Restore**

Restore all settings to default values.

---

Restore all configuration settings to default values, except your login and cloud account information.

[RESTORE](#)

2. Wait a few minutes for the resetting and rebooting.

**Note:**

- During the resetting process, do not turn off the router.
- After reset, you can still use the current login password or the TP-Link ID to log in to the web management page.

**To reset the router to factory default settings:**

1. Click [FACTORY RESTORE](#) to reset the router.

Restore all the configuration settings to their default values.

[FACTORY RESTORE](#)

2. Wait a few minutes for the resetting and rebooting.

**Note:**

- During the resetting process, do not turn off or reset the router.
- We strongly recommend you backup the current configuration settings before resetting the router.

## 15.3. Change the Login Password

The account management feature allows you to change your login password of the web management page.

**Note:** If you are using a TP-Link ID to log in to the web management page, the account management feature will be disabled. To manage the TP-Link ID, go to [Advanced > TP-Link ID](#).

1. Visit <http://tplinkwifi.net>, and log in with the password you set for the router.
2. Go to [Advanced > System > Administration](#) and focus on the [Change Password](#) section.

**Change Password**

Change the router's local management password.

---

Old Password:

New Password:

Confirm New Password:

3. Enter the old password, then a new password twice (both case-sensitive). Click [SAVE](#).



4. Use the new password for future logins.

## 15.4. Password Recovery

This feature allows you to recover the login password you set for your router in case you forget it.

**Note:** If you are using a TP-Link ID to log in to the web management page, the Password Recovery feature will be disabled. To manage the TP-Link ID, go to [Advanced > TP-Link ID](#).

1. Visit <http://tplinkwifi.net>, and log in with the password you set for the router.
2. Go to [Advanced > System > Administration](#) and focus on the [Password Recovery](#) section.
3. Tick the [Enable](#) box of [Password Recovery](#).
4. Specify a [mailbox \(From\)](#) for sending the recovery letter and enter its [SMTP Server](#) address. Specify a [mailbox \(To\)](#) for receiving the recovery letter. If the mailbox (From) to send the recovery letter requires encryption, Tick the [Enable](#) box of [Authentication](#) and enter its username and password.

**Tips:**

- SMTP server is available for users in most webmail systems. For example, the SMTP server address of Gmail is smtp.gmail.com.
- Generally, Authentication should be enabled if the login of the mailbox requires username and password.

### Password Recovery

Reset local management password via preset questions and answers.

Password Recovery:  Enable



From:

To:

SMTP Server:

Authentication:  Enable

Username:

Password:   

5. Click [SAVE](#).

To recover the login password, please visit <http://tplinkwifi.net>, click [Forgot Password?](#) on the login page and follow the instructions to set a new password.

## 15.5. Local Management

This feature allows you to limit the number of client devices on your LAN from accessing the router by using the MAC address-based authentication.

1. Visit <http://tplinkwifi.net>, and log in with your TP-Link ID or the password you set for the router.
2. Go to **Advanced > System > Administration** and complete the settings In **Local Management** section as needed.

- **Access the router via HTTPS and HTTP:**

Tick the **Enable** box of **Local Management via HTTPS** to access the router via HTTPS and HTTP, or keep it disabled to access the router only via HTTP.

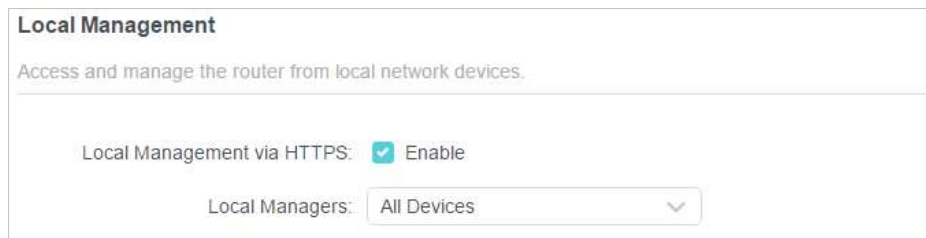

The screenshot shows the 'Local Management' configuration page. At the top, it says 'Local Management' and 'Access and manage the router from local network devices.' Below this, there is a checkbox for 'Local Management via HTTPS' which is checked and labeled 'Enable'. Underneath, there is a dropdown menu for 'Local Managers' currently set to 'All Devices'.

- **Allow all LAN connected devices to manage the router:**

Select **All Devices** for **Local Managers**.

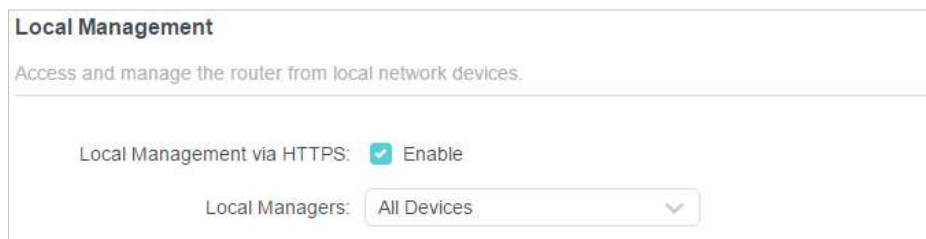

This screenshot is identical to the one above, showing the 'Local Management' settings with 'Local Management via HTTPS' checked and 'Local Managers' set to 'All Devices'.

- **Allow specific devices to manage the router:**

1. Select **All Devices** for **Local Managers** and click **SAVE**.

**Local Management**

Access and manage the router from local network devices.

---

Local Management via HTTPS:  Enable

Local Managers: Specified Devices + Add Device

Description	MAC Address	Operation
No Entries		

2. Click [Add Device](#).

Add Device ✕

---

Description:

[VIEW CONNECTED DEVICES](#)

MAC Address:

CANCEL
SAVE

3. Click [VIEW CONNECTED DEVICES](#) and select the device to manage the router from the Connected Devices list, or enter the MAC address of the device manually.

4. Specify a [Description](#) for this entry.

5. Click [SAVE](#).

## 15.6. Remote Management

This feature allows you to control remote devices' authority to manage the router.

1. Visit <http://tplinkwifi.net>, and log in with your TP-Link ID or the password you set for the router.

2. Go to [Advanced](#) > [System](#) > [Administration](#) and complete the settings in [Remote Management](#) section as needed.

- **Forbid all devices to manage the router remotely:**

Do not tick the [Enable](#) checkbox of [Remote Management](#).

**Remote Management**

Access and manage the router over the internet.

---

**Note:** Remote Management is not supported when you are connected to the internet only via IPv6. If you want to use Remote Management, please make sure you have set up an IPv4 connection first.

Remote Management:  Enable

- **Allow all devices to manage the router remotely:**

**Remote Management**

Access and manage the router over the internet.

---

**Note:** Remote Management is not supported when you are connected to the internet only via IPv6. If you want to use Remote Management, please make sure you have set up an IPv4 connection first.

Remote Management:  Enable

HTTPS Port:

HTTP Port:

Web Address for Management:

Remote Managers:  ▼

1. Tick the **Enable** checkbox of **Remote Management**.
2. Keep the HTTPS and HTTP port as default settings (recommended) or enter a value between 1024 and 65535.
3. Select **All Devices** for **Remote Managers**.
4. Click **SAVE**.

Devices on the internet can log in to <http://Router's WAN IP address:port number> (such as <http://113.116.60.229:1024>) to manage the router.

 **Tips:**

- You can find the WAN IP address of the router on [Network Map > Internet](#).
- The router's WAN IP is usually a dynamic IP. Please refer to [Set Up a Dynamic DNS Service Account](#) if you want to log in to the router through a domain name.

- **Allow a specific device to manage the router remotely:**

### Remote Management

Access and manage the router over the internet.

**Note:** Remote Management is not supported when you are connected to the internet only via IPv6. If you want to use Remote Management, please make sure you have set up an IPv4 connection first.

Remote Management:  Enable

HTTPS Port:

HTTP Port:

Web Address for Management:

Remote Managers:

Only this IP Address:

1. Tick the **Enable** checkbox of **Remote Management**.
2. Keep the HTTPS and HTTP port as default settings (recommended) or enter a value between 1024 and 65535.
3. Select **Specified Device** for **Remote Managers**.
4. In the **Only this IP Address** field, enter the IP address of the remote device to manage the router.
5. Click **SAVE**.

Devices using this WAN IP can manage the router by logging in to <http://Router's WAN IP:port number> (such as <http://113.116.60.229:1024>).

 **Tips:** The router's WAN IP is usually a dynamic IP. Please refer to [Set Up a Dynamic DNS Service Account](#) if you want to log in to the router through a domain name.

## 15.7. System Log

When the router does not work normally, you can save the system log and send it to the technical support for troubleshooting.

- **To save the system log locally:**
  1. Visit <http://tplinkwifi.net>, and log in your TP-Link ID or the password you set for the router.
  2. Go to **Advanced > System > System Log**.
  3. Choose the type and level of the system logs as needed.

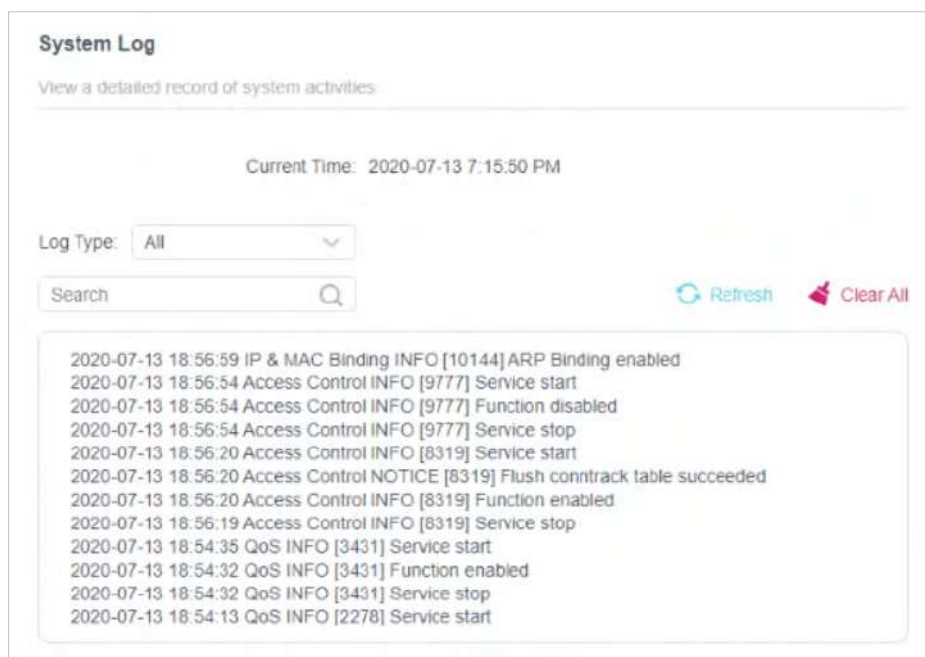

4. In the [Save Log](#) section, click [SAVE TO LOCAL](#) to save the system logs to a local disk.

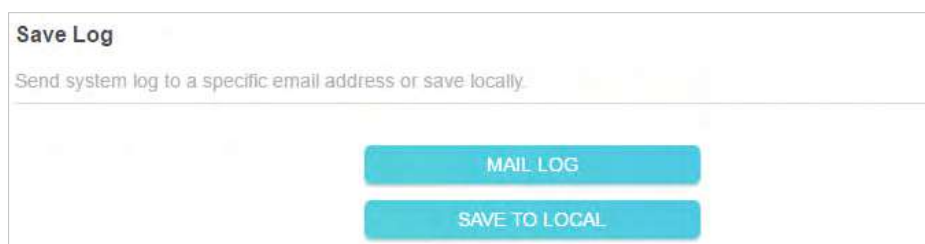

- To send the system log to a mailbox at a fixed time:

For example, I want to check my router's working status at a fixed time every day, however, it's too troublesome to log in to the web management page every time I want to go checking. It would be great if the system logs could be sent to my mailbox at 8 a.m. every day.

1. Visit <http://tplinkwifi.net>, and log in with your TP-Link ID or the password you set for the router.
2. Go to [Advanced](#) > [System Tools](#) > [System Log](#).
3. In the [Save Log](#) section, click [MAIL LOG](#).
4. Enter the information required:

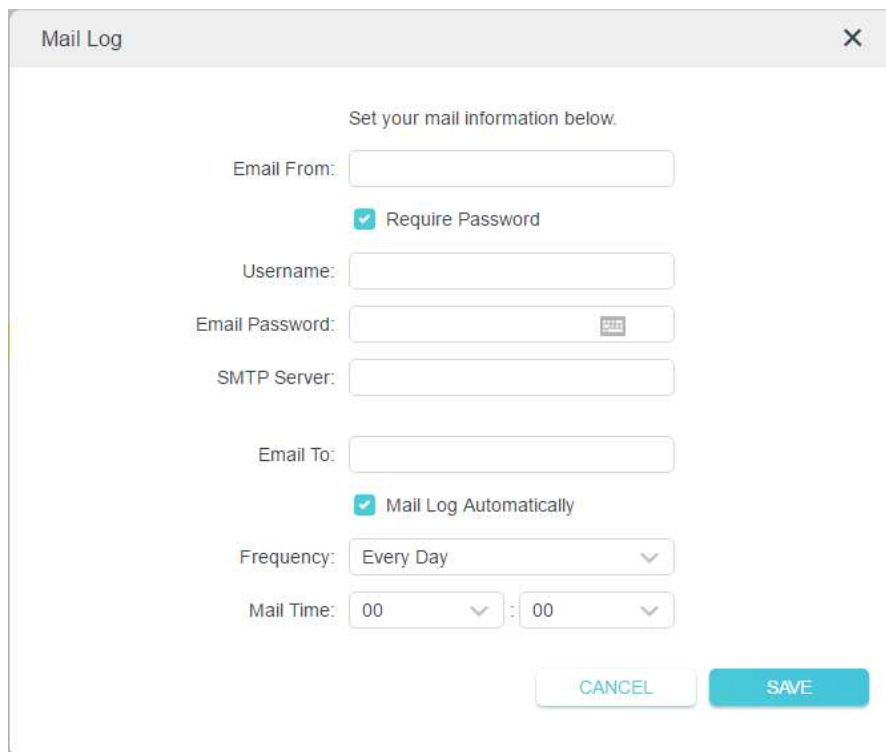

The image shows a 'Mail Log' configuration dialog box. It has a title bar with 'Mail Log' and a close button. The main content area contains the following fields and options:

- Instruction: 'Set your mail information below.'
- Field: 'Email From:' with an empty text input box.
- Option: A checked checkbox labeled 'Require Password'.
- Field: 'Username:' with an empty text input box.
- Field: 'Email Password:' with an empty password input box (indicated by a small keyboard icon).
- Field: 'SMTP Server:' with an empty text input box.
- Field: 'Email To:' with an empty text input box.
- Option: A checked checkbox labeled 'Mail Log Automatically'.
- Field: 'Frequency:' with a dropdown menu showing 'Every Day'.
- Field: 'Mail Time:' with two dropdown menus, both showing '00'.
- Buttons: 'CANCEL' and 'SAVE' at the bottom right.

1) **Email From:** Enter the email address used for sending the system log.

2) Select **Require Password**.

☞ **Tips:** Generally, Require Password should be selected if the login of the mailbox requires username and password.

3) **Username:** Enter the email address used for sending the system log.

4) **Email Password:** Enter the password to login the sender's email address.

5) **SMTP Server:** Enter the SMTP server address.

☞ **Tips:** SMTP server is available for users in most webmail systems. For example, the SMTP server address of Hotmail is smtp-mail.outlook.com.

6) **Email To:** Enter the recipient's email address, which can be the same as or different from the sender's email address.

7) Select **Mail Log Automatically**.

☞ **Tips:** The router will send the system log to the designated email address if this option is enabled.

8) **Frequency:** This determines how often the recipient will receive the system log .

5. Click **SAVE**.

## 15. 8. Test the Network Connectivity

Diagnostics is used to test the connectivity between the router and the host or other network devices.

1. Visit <http://tplinkwifi.net>, and log in with your TP-Link ID or the password you set for the router.
2. Go to **Advanced > System > Diagnostics**.

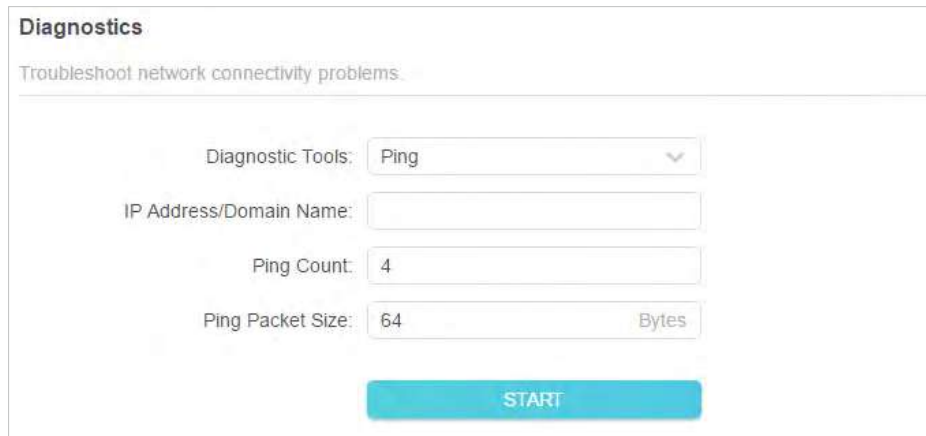

**Diagnostics**  
Troubleshoot network connectivity problems.

Diagnostic Tools:

IP Address/Domain Name:

Ping Count:

Ping Packet Size:  Bytes

**START**

3. Enter the information:

- 1) Choose **Ping** or **Traceroute** as the diagnostic tool to test the connectivity;
  - **Ping** is used to test the connectivity between the router and the tested host, and measure the round-trip time.
  - **Traceroute** is used to display the route (path) your router has passed to reach the tested host, and measure transit delays of packets across an Internet Protocol network.
- 2) Enter the **IP Address** or **Domain Name** of the tested host.
- 3) Modify the **Ping Count** number and the **Ping Packet Size**. It's recommended to keep the default value.
- 4) If you have chosen **Traceroute**, you can modify the **Traceroute Max TTL**. It's recommended to keep the default value.

4. Click **START** to begin the diagnostics.

The figure below indicates the proper connection between the router and the Yahoo server ([www.Yahoo.com](http://www.Yahoo.com)) tested through **Ping**.

```
PING 192.168.0.1 (192.168.0.1): 64 data bytes
Reply from 192.168.0.1: bytes=64 ttl=64 seq=1 time=0.322 ms
Reply from 192.168.0.1: bytes=64 ttl=64 seq=2 time=0.308 ms
Reply from 192.168.0.1: bytes=64 ttl=64 seq=3 time=0.286 ms
Reply from 192.168.0.1: bytes=64 ttl=64 seq=4 time=0.334 ms
--- Ping Statistics for 192.168.0.1: ---
Packets: Sent=4, Received=4, Lost=0 (0.00% loss)
Round-trip min/avg/max = 0.286/0.312/0.334 ms
ping is stopped.
```



The figure below indicates the proper connection between the router and the Yahoo server (www.Yahoo.com) tested through [Traceroute](#).

```

traceroute to 192.168.0.1, 5 hops max, 38 byte packets
 1 Archer (192.168.0.1) 0.045 ms 0.015 ms 0.008 ms
Trace Complete.
traceroute is stopped.

```

## 15.9. Set System Time and Language

System time is the time displayed while the router is running. The system time you configure here will be used for other time-based functions like Parental Controls. You can choose the way to obtain the system time as needed.

System language is the language displayed when you log into the router. You can change the system language as needed.

1. Visit <http://tplinkwifi.net>, and log in with your TP-Link ID or the password you set for the router.
  2. Go to [Advanced](#) > [System](#) > [Time & Language](#).
- **To get time from the internet:**
    1. Enable [24-Hour Time](#) if you want the time to display in a 24-hour way.
    2. In the [Set Time](#) field, select [Get from Internet](#).

**System Time**

Set the router's system time.

---

Current Time: 2020-05-28 07:22:42

24-Hour Time:

Set Time:

Time Zone:

NTP Server I:

NTP Server II:  (Optional)

3. Select your local [Time Zone](#) from the drop-down list.

4. In the **NTP Server I** field, enter the IP address or domain name of your desired NTP Server.
5. (Optional) In the **NTP Server II** field, enter the IP address or domain name of the second NTP Server.
6. Click **SAVE**.

- **To get time from your computer:**

1. In the **Set Time** field, select **Get from Managing Device**.

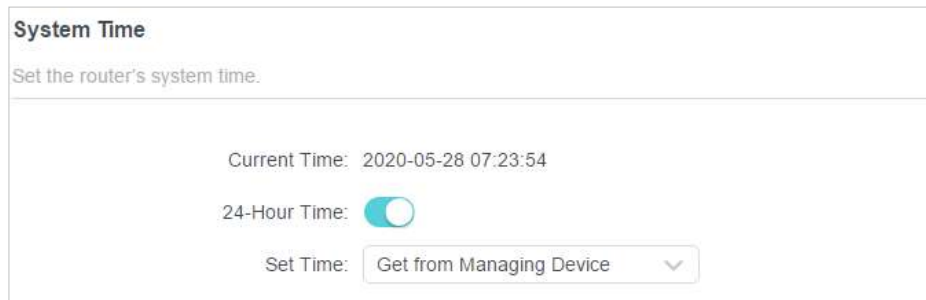

**System Time**  
Set the router's system time.

Current Time: 2020-05-28 07:23:54

24-Hour Time:

Set Time: **Get from Managing Device**

2. The time of your computer will then be displayed and click **SAVE**.

- **To manually set the date and time:**

1. In the **Set Time** field, select **Manually**.

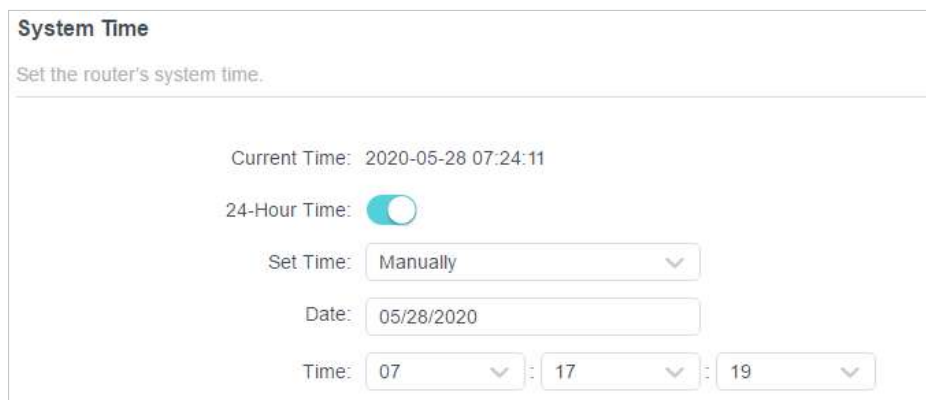

**System Time**  
Set the router's system time.

Current Time: 2020-05-28 07:24:11

24-Hour Time:

Set Time: **Manually**

Date: 05/28/2020

Time: 07 : 17 : 19

2. Set the current **Date** (In **MM/DD/YYYY** format).
3. Set the current **Time** (In **HH/MM/SS** format).
4. Click **SAVE**.

- **To set Daylight Saving Time:**

1. Tick the **Enable** box of **Daylight Saving Time**.

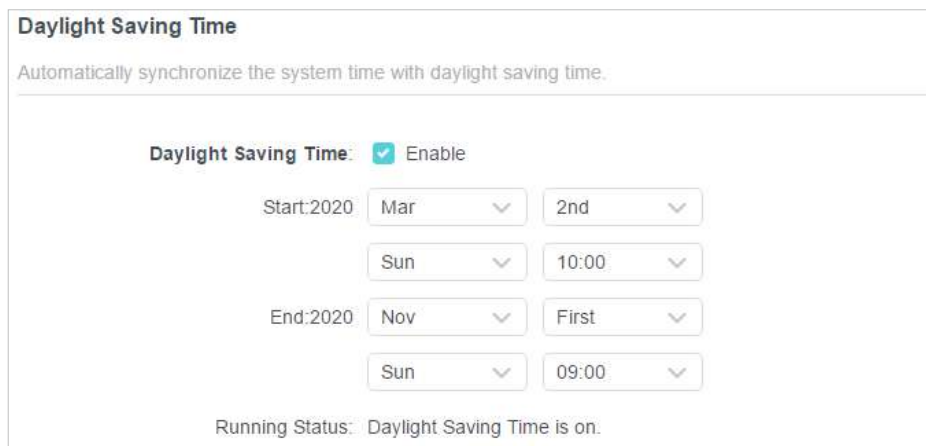

**Daylight Saving Time**  
Automatically synchronize the system time with daylight saving time.

**Daylight Saving Time:**  Enable

Start:2020 Mar 2nd Sun 10:00

End:2020 Nov First Sun 09:00

Running Status: Daylight Saving Time is on.

2. Select the correct **Start** date and time when daylight saving time starts at your local time zone.
3. Select the correct **End** date and time when daylight saving time ends at your local time zone.
4. Click **SAVE**.

- **To set system language:**

Select the language from the dropdown list, then click **SAVE**.

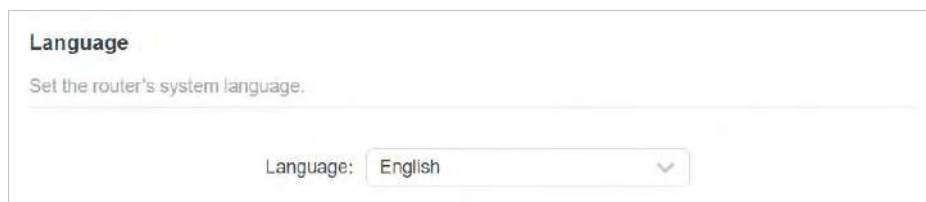

**Language**  
Set the router's system language.

Language: English

## 15. 10. Set the Router to Reboot Regularly

The Scheduled Reboot feature cleans the cache to enhance the running performance of the router.

1. Visit <http://tplinkwifi.net>, and log in with your TP-Link ID or the password you set for the router.
2. Go to **Advanced > System > Reboot**.
3. Tick the **Enable** box of **Reboot Schedule**.

### Reboot Schedule

Set when and how often the router reboots automatically.

---

**Reboot Schedule:**  Enable

**Note:** Make sure [Time Settings](#) are correct before using this function.

**Current Time:** 2020-05-28 07:25:44

Reboot Time: 03 : 00

Repeat: Every Week

Monday

4. Specify the [Reboot Time](#) when the router reboots and [Repeat](#) to decide how often it reboots.
5. Click [SAVE](#).

## 15. 11. Control the LED

The LED of the router indicates its activities and status. You can enable the Night Mode feature to specify a time period during which the LED is off.

1. Visit <http://tplinkwifi.net>, and log in with your TP-Link ID or the password you set for the router.
2. Go to [Advanced](#) > [System](#) > [LED Control](#).
3. Enable [Night Mode](#).
4. Specify the LED off time, and the LED will be off during this period every day.
5. Click [SAVE](#).

### LED Control

Turn the router's LEDs on or off.

---

LED Status:

### Night Mode

Set a time period when the LEDs will be off automatically.

---

**Night Mode:**  Enable

**Note:** Make sure [Time Settings](#) are correct before using this function.

**Current Time:** 2020-05-28 07:27:05

LED Off From: 22 : 00

To: 06 : 00 (next day)

# FAQ

## Q1. What should I do if I forget my wireless password?

The default wireless password is printed on the label of the router. If the password has been altered:

1. Connect your computer to the router using an Ethernet cable.
2. Visit <http://tplinkwifi.net>, and log in with your TP-Link ID or the password you set for the router.
3. Go to [Wireless](#) to retrieve or reset your wireless password.

## Q2. What should I do if I forget my web management password?

- If you are using a TP-Link ID to log in, or you have enabled the Password Recovery feature of the router, click [Forgot password](#) on the login page and then follow the instructions to reset it.
- Alternatively, press and hold the [Reset](#) button of the router for about 6 seconds until the Power LED blinks to restore factory default settings, and then visit <http://tplinkwifi.net> to create a new login password.

### Note:

- Please refer to [Password Recovery](#) to learn how to configure Password Recovery.
- You'll need to reconfigure the router to surf the internet once the router is reset, and please mark down your new password for future use.

## Q3. What should I do if I can't log in to the router's web management page?

This can happen for a variety of reasons. Please try the methods below to log in again.

- Make sure your computer is connected to the router correctly and the corresponding LED indicator(s) light up.
- Make sure the IP address of your computer is configured as [Obtain an IP address automatically](#) and [Obtain DNS server address automatically](#).
- Make sure <http://tplinkwifi.net> or <http://192.168.0.1> is correctly entered.
- Check your computer's settings:
  - 1) Go to [Start](#) > [Control Panel](#) > [Network and Internet](#), and click [View network status and tasks](#).
  - 2) Click [Internet Options](#) on the bottom left.
  - 3) Click [Connections](#) and select [Never dial a connection](#).

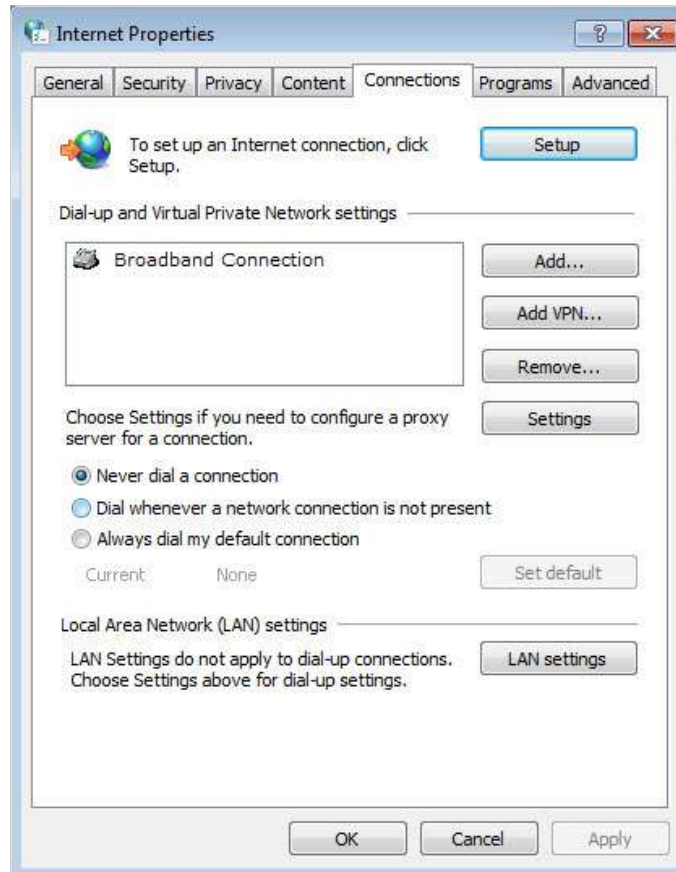

4) Click [LAN settings](#) and deselect the following three options and click [OK](#).



5) Go to [Advanced](#) > [Restore advanced settings](#), click [OK](#) to save the settings.

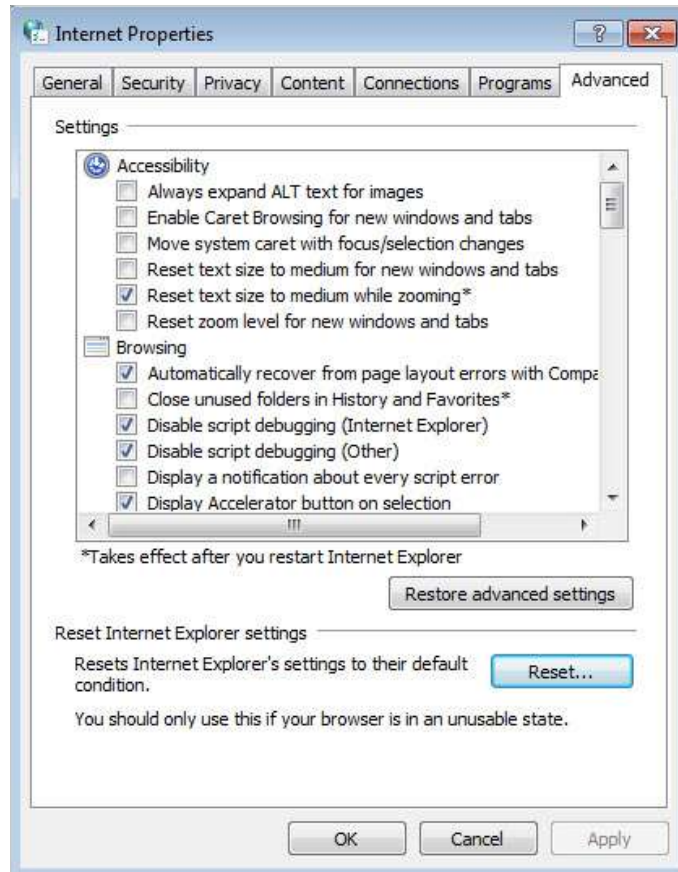

- Use another web browser or computer to log in again.
- Reset the router to factory default settings and try again. If login still fails, please contact the technical support.

ⓘ Note: You'll need to reconfigure the router to surf the internet once the router is reset.

#### Q4. What should I do if I can't access the internet even though the configuration is finished?

1. Visit <http://tplinkwifi.net>, and log in with your TP-Link ID or the password you set for the router.
2. Go to [Advanced](#) > [Network](#) > [Status](#) to check internet status:

If IP Address is a valid one, please try the methods below and try again:

- Your computer might not recognize any DNS server addresses. Please manually configure the DNS server.
  - 1) Go to [Advanced](#) > [Network](#) > [DHCP Server](#).
  - 2) Enter 8.8.8.8 as Primary DNS, click [SAVE](#).

💡 Tips: 8.8.8.8 is a safe and public DNS server operated by Google.

**DHCP Server**

Dynamically assign IP addresses to the devices connected to the router.

---

**DHCP Server:**  Enable

IP Address Pool:  -

Address Lease Time:  minutes

Default Gateway:  (Optional)

Primary DNS:  (Optional)

Secondary DNS:  (Optional)

- Restart the modem and the router.
  - 1) Power off your modem and router, and leave them off for 1 minute.
  - 2) Power on your modem first, and wait about 2 minutes until it gets a solid cable or Internet light.
  - 3) Power on the router.
  - 4) Wait another 1 or 2 minutes and check the internet access.
- Reset the router to factory default settings and reconfigure the router.
- Upgrade the firmware of the router.
- Check the TCP/IP settings on the particular device if all other devices can get internet from the router.

**As the picture below shows, if the IP Address is 0.0.0.0, please try the methods below and try again:**

**Status**

Internet status overview is displayed on this page.

---

**Internet**

Status: WAN port is unplugged

Internet Connection Type: Dynamic IP

IP Address: 0.0.0.0

Subnet Mask: 0.0.0.0

Default Gateway: 0.0.0.0

Primary DNS: 0.0.0.0

Secondary DNS: 0.0.0.0

- Make sure the physical connection between the router and the modem is proper.
- Clone the MAC address of your computer.



- 1) Visit <http://tplinkwifi.net>, and log in with your TP-Link ID or the password you set for the router.
- 2) Go to [Internet](#) or [Advanced](#) > [Network](#) > [Internet](#) and focus on the [MAC Clone](#) section.
- 3) Choose an option as needed (enter the MAC address if [Use Custom MAC Address](#) is selected), and click [SAVE](#).

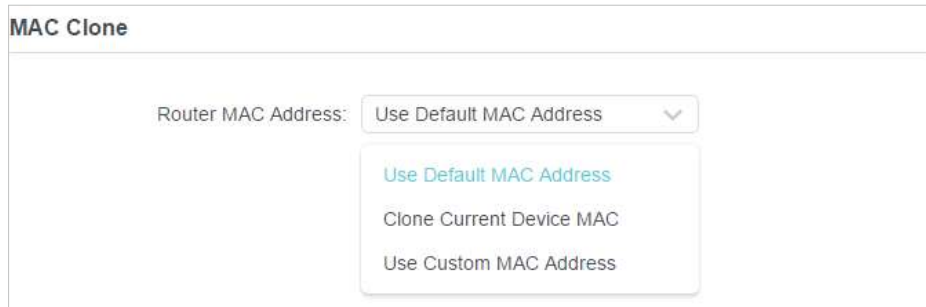

 **Tips:**

- Some ISP will register the MAC address of your computer when you access the internet for the first time through their Cable modem, if you add a router into your network to share your internet connection, the ISP will not accept it as the MAC address is changed, so we need to clone your computer's MAC address to the router.
- The MAC addresses of a computer in wired connection and wireless connection are different.

- **Modify the LAN IP address of the router.**

 **Note:**

Most TP-Link routers use 192.168.0.1/192.168.1.1 as their default LAN IP address, which may conflict with the IP range of your existing ADSL modem/router. If so, the router is not able to communicate with your modem and you can't access the internet. To resolve this problem, we need to change the LAN IP address of the router to avoid such conflict, for example, 192.168.2.1.

- 1) Visit <http://tplinkwifi.net>, and log in with your TP-Link ID or the password you set for the router.
- 2) Go to [Advanced](#) > [Network](#) > [LAN](#).
- 3) Modify the LAN IP address as the follow picture shows. Here we take 192.168.2.1 as an example.
- 4) Click [SAVE](#).



- **Restart the modem and the router.**

- 1) Power off your modem and router, and leave them off for 1 minute.
  - 2) Power on your modem first, and wait about 2 minutes until it get a solid cable or Internet light.
  - 3) Power on the router.
  - 4) Wait another 1 or 2 minutes and check the internet access.
- Double check the internet connection type.
    - 1) Confirm your internet connection type, which can be learned from the ISP.
    - 2) Visit <http://tplinkwifi.net>, and log in with your TP-Link ID or the password you set for the router.
    - 3) Go to [Advanced](#) > [Network](#) > [Internet](#).
    - 4) Select your [Internet Connection Type](#) and fill in other parameters.
    - 5) Click [SAVE](#).

**Internet**

Set up an internet connection with the service information provided by your ISP (internet service provider).

---

Internet Connection Type: Dynamic IP

IP Address: Static IP

Subnet Mask: Dynamic IP

Default Gateway: PPPoE

Primary DNS: L2TP

Secondary DNS: PPTP

Secondary DNS: 0.0.0.0

RENEW  
RELEASE

- 6) Restart the modem and the router again.
- Please upgrade the firmware of the router.
- If you've tried every method above but still cannot access the internet, please contact the technical support.

**Q5. What should I do if I can't find my wireless network or I cannot connect the wireless network?**

If you fail to find any wireless network, please follow the steps below:

- Make sure the wireless function of your device is enabled if you're using a laptop with built-in wireless adapter. You can refer to the relevant document or contact the laptop manufacturer.

- Make sure the wireless adapter driver is installed successfully and the wireless adapter is enabled.

- **On Windows 7**

- 1) If you see the message [No connections are available](#), it is usually because the wireless function is disabled or blocked somehow.
- 2) Click [Troubleshoot](#) and windows might be able to fix the problem by itself.

- **On Windows XP**

- 1) If you see the message [Windows cannot configure this wireless connection](#), this is usually because windows configuration utility is disabled or you are running another wireless configuration tool to connect the wireless.
- 2) Exit the wireless configuration tool (the TP-Link Utility, for example).
- 3) Select and right click on [My Computer](#) on desktop, select [Manage](#) to open Computer Management window.
- 4) Expand [Services and Applications](#) > [Services](#), find and locate [Wireless Zero Configuration](#) in the Services list on the right side.
- 5) Right click [Wireless Zero Configuration](#), and then select [Properties](#).
- 6) Change [Startup type](#) to [Automatic](#), click on Start button and make sure the Service status is [Started](#). And then click [OK](#).

**If you can find other wireless network except your own, please follow the steps below:**

- Check the WLAN LED indicator on your wireless router/modem.
- Make sure your computer/device is still in the range of your router/modem. Move it closer if it is currently too far away.
- Go to [Wireless](#) or [Advanced](#) > [Wireless](#) > [Wireless Settings](#), and check the wireless settings. Double check your wireless Network Name and SSID is not hidid.

**If you can find your wireless network but fail to connect, please follow the steps below:**

- **Authenticating problem/password mismatch:**

- 1) Sometimes you will be asked to type in a PIN number when you connect to the wireless network for the first time. This PIN number is different from the Wireless Password/Network Security Key, usually you can only find it on the label of your router.



- 2) If you cannot find the PIN or PIN failed, you may choose [Connecting using a security key instead](#), and then type in the [Wireless Password/Network Security Key](#).
- 3) If it continues to show note of [Network Security Key Mismatch](#), it is suggested to confirm the wireless password of your wireless router.

**Note:** Wireless Password/Network Security Key is case sensitive.

- **Windows unable to connect to XXXX / Can not join this network / Taking longer than usual to connect to this network:**
  - Check the wireless signal strength of your network. If it is weak (1~3 bars), please move the router closer and try again.
  - Change the wireless Channel of the router to 1, 6 or 11 to reduce interference from other networks.
  - Re-install or update the driver for your wireless adapter of the computer.

## FCC compliance information statement



**Product Name:** AXE5400 Tri-Band Wi-Fi 6E Router

**Model Number:** Archer AXE75

Component Name	Model
I.T.E. Power Supply	NBS30D120250VU

### **Responsible party:**

**TP-Link USA Corporation**

Address: 10 Mauchly, Irvine, CA 92618

Website: <http://www.tp-link.com/us/>

Tel: +1 626 333 0234

Fax: +1 909 527 6804

E-mail: [sales.usa@tp-link.com](mailto:sales.usa@tp-link.com)

This equipment has been tested and found to comply with the limits for a Class B digital device, pursuant to part 15 of the FCC Rules. These limits are designed to provide reasonable protection against harmful interference in a residential installation. This equipment generates, uses and can radiate radio frequency energy and, if not installed and used in accordance with the instructions, may cause harmful interference to radio communications. However, there is no guarantee that interference will not occur in a particular installation. If this equipment does cause harmful interference to radio or television reception, which can be determined by turning the equipment off and on, the user is encouraged to try to correct the interference by one or more of the following measures:

- Reorient or relocate the receiving antenna.
- Increase the separation between the equipment and receiver.
- Connect the equipment into an outlet on a circuit different from that to which the receiver is connected.
- Consult the dealer or an experienced radio/ TV technician for help.

This device complies with part 15 of the FCC Rules. Operation is subject to the following two conditions:

1. This device may not cause harmful interference.
2. This device must accept any interference received, including interference that may cause undesired operation.

Any changes or modifications not expressly approved by the party responsible for compliance could void the user's authority to operate the equipment.

Note: The manufacturer is not responsible for any radio or TV interference caused by unauthorized modifications to this equipment. Such modifications could void the user's authority to operate the equipment.

### **FCC RF Radiation Exposure Statement**

This equipment complies with FCC RF radiation exposure limits set forth for an uncontrolled environment. This device and its antenna must not be co-located or operating in conjunction with any other antenna or transmitter.

"To comply with FCC RF exposure compliance requirements, this grant is applicable to only Mobile Configurations. The antennas used for this transmitter must be installed to provide a separation distance of at least 20 cm from all persons and must not be co-located or operating in conjunction with any other antenna or transmitter."

FCC regulations restrict operation of this device to indoor use only. The operation of this device is prohibited on oil platforms, cars, trans, boats, and aircraft, except that operation of this device is permitted in large aircraft while flying above 10000 feet. Operation of transmitters in the 5.925-7.125 GHz band is prohibited for control of or communications with unmanned aircraft systems.

### **FCC compliance information statement**

**Product Name: I.T.E. Power Supply**

**Model Number: NBS30D120250VU**

**Responsible party:**

**TP-Link USA Corporation**

Address: 10 Mauchly, Irvine, CA 92618

Website: <http://www.tp-link.com/us/>

Tel: +1 626 333 0234

Fax: +1 909 527 6804

E-mail: [sales.usa@tp-link.com](mailto:sales.usa@tp-link.com)

This equipment has been tested and found to comply with the limits for a Class B digital device, pursuant to part 15 of the FCC Rules. These limits are designed to provide reasonable protection against harmful interference in a residential installation. This equipment generates, uses and can radiate radio frequency energy and, if not installed and used in accordance with the instructions, may cause harmful interference to radio communications. However, there is no guarantee that interference will not occur in a particular installation. If this equipment does cause harmful interference to radio or television reception, which can be determined by turning the equipment off and on, the user is encouraged to try to correct the interference by one or more of the following measures:

- Reorient or relocate the receiving antenna.
- Increase the separation between the equipment and receiver.
- Connect the equipment into an outlet on a circuit different from that to which the receiver is connected.
- Consult the dealer or an experienced radio/ TV technician for help.

This device complies with part 15 of the FCC Rules. Operation is subject to the following two conditions:

1. This device may not cause harmful interference.
2. This device must accept any interference received, including interference that may cause undesired operation.

Any changes or modifications not expressly approved by the party responsible for compliance could void the user's authority to operate the equipment.

We, **TP-Link USA Corporation**, has determined that the equipment shown as above has been shown to comply with the applicable technical standards, FCC part 15. There is no unauthorized change is made in the equipment and the equipment is properly maintained and operated.

Issue Date: 2022-12-07

## CE Mark Warning



This is a class B product. In a domestic environment, this product may cause radio interference, in which case the user may be required to take adequate measures.

### **OPERATING FREQUENCY(the maximum transmitted power)**

2400 MHz -2483.5 MHz (20dBm)

5150 MHz -5250 MHz (23dBm)

5250 MHz -5350 MHz (23dBm)

5470 MHz -5725 MHz (30dBm)

5945MHz -6425 MHz (23dBm)

#### **Frequency band: 5150 - 5250 MHz:**

Indoor use: Inside buildings only. Installations and use inside road vehicles and train carriages are not permitted. Limited outdoor use: If used outdoors, equipment shall not be attached to a fixed installation or to the external body of road vehicles, a fixed infrastructure or a fixed outdoor antenna. Use by unmanned aircraft systems (UAS) is limited to within the 5170 - 5250 MHz band.

#### **Frequency band: 5250 - 5350 MHz:**

Indoor use: Inside buildings only. Installations and use in road vehicles, trains and aircraft are not permitted. Outdoor use is not permitted.

#### **Frequency band: 5470 - 5725 MHz:**

Installations and use in road vehicles, trains and aircraft and use for unmanned aircraft systems (UAS) are not permitted.

## **EU Declaration of Conformity**

TP-Link hereby declares that the device is in compliance with the essential requirements and other relevant provisions of directives 2014/53/EU, 2009/125/EC, 2011/65/EU and (EU)2015/863.

The original EU Declaration of Conformity may be found at <https://www.tp-link.com/en/support/ce/>



## RF Exposure Information

This device meets the EU requirements (2014/53/EU Article 3.1a) on the limitation of exposure of the general public to electromagnetic fields by way of health protection. The device complies with RF specifications when the device used at 20 cm from your body.

## National Restrictions

Attention: This device may only be used indoors in all EU member states, EFTA countries and Northern Ireland.

	AT	BE	BG	CH	CY	CZ	DE	DK
	EE	EL	ES	FI	FR	HR	HU	IE
	IS	IT	LI	LT	LU	LV	MT	NL
	NO	PL	PT	RO	SE	SI	SK	UK(NI)

## UKCA Mark



## UK Declaration of Conformity

TP-Link hereby declares that the device is in compliance with the essential requirements and other relevant provisions of the Radio Equipment Regulations 2017.

The original UK Declaration of Conformity may be found at <https://www.tp-link.com/support/ukca>

## National Restrictions

Attention: This device may only be used indoors in Great Britain.



## Canadian Compliance Statement

This device contains licence-exempt transmitter(s)/receiver(s) that comply with Innovation, Science and Economic Development Canada's licence-exempt RSS(s). Operation is subject to the following two conditions:

- (1) This device may not cause interference.
- (2) This device must accept any interference, including interference that may cause undesired operation of the device.

L'émetteur/récepteur exempt de licence contenu dans le présent appareil est conforme aux CNR d'Innovation, Sciences et Développement économique Canada applicables aux appareils radio exempts de licence. L'exploitation est autorisée aux deux conditions suivantes :

- 1) L'appareil ne doit pas produire de brouillage;
- 2) L'appareil doit accepter tout brouillage radioélectrique subi, même si le brouillage est susceptible d'en compromettre le fonctionnement.

**Caution:**

1. The device for operation in the band 5150–5250 MHz is only for indoor use to reduce the potential for harmful interference to co-channel mobile satellite systems;

DFS (Dynamic Frequency Selection) products that operate in the bands 5250-5350 MHz, 5470-5600MHz, and 5650-5725MHz.

**Avertissement:**

1. Le dispositif fonctionnant dans la bande 5150-5250 MHz est réservé uniquement pour une utilisation à l'intérieur afin de réduire les risques de brouillage préjudiciable aux systèmes de satellites mobiles utilisant les mêmes canaux;

Les produits utilisant la technique d'atténuation DFS (sélection dynamique des fréquences) sur les bandes 5250- 5350 MHz, 5470-5600MHz et 5650-5725MHz.

**Radiation Exposure Statement:**

This equipment complies with IC radiation exposure limits set forth for an uncontrolled environment. This equipment should be installed and operated with minimum distance 20cm between the radiator & your body.

**Déclaration d'exposition aux radiations:**

Cet équipement est conforme aux limites d'exposition aux rayonnements IC établies pour un environnement non contrôlé. Cet équipement doit être installé et utilisé avec un minimum de 20 cm de distance entre la source de rayonnement et votre corps.

ISED regulations restrict operation of this device to indoor use only. The operation of this device is prohibited on oil platforms, cars, trains, boats, and aircraft, except that operation of this device is permitted in large aircraft while flying above 10000 feet. Operation of transmitters in the 5.925-7.125 GHz band is prohibited for control of or communications with unmanned aircraft systems.

Les réglementations ISED limitent le fonctionnement de cet appareil à une utilisation en intérieur uniquement. L'utilisation de cet appareil est interdite sur les plates-formes pétrolières, les voitures, les trains, les bateaux et les avions, sauf que l'utilisation de cet appareil est autorisée dans les avions long courrier en vol au-dessus de 10 000 pieds. L'exploitation d'émetteurs dans la bande 5,925-7,125 GHz est interdite pour le contrôle ou les communications avec des systèmes d'avions sans pilote.

## Industry Canada Statement

CAN ICES-3 (B)/NMB-3(B)

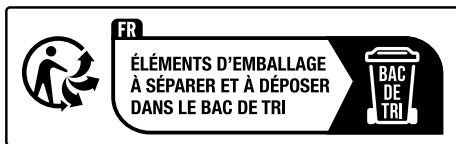

## Korea Warning Statements:

당해 무선설비는 운용중 전파혼신 가능성이 있음.

## NCC Notice & BSMI Notice:

注意!

取得審驗證明之低功率射頻器材，非經核准，公司、商號或使用者均不得擅自變更頻率、加大功率或變更原設計之特性及功能。

低功率射頻器材之使用不得影響飛航安全及干擾合法通信；經發現有干擾現象時，應立即停用，並改善至無干擾時方得繼續使用。

前述合法通信，指依電信管理法規定作業之無線電通信。

低功率射頻器材須忍受合法通信或工業、科學及醫療用電波輻射性電機設備之干擾。

應避免影響附近雷達系統之操作。

高增益指向性天線只得應用於固定式點對點系統。

## 安全諮詢及注意事項

- 請使用原裝電源供應器或只能按照本產品注明的電源類型使用本產品。

- 清潔本產品之前請先拔掉電源線。請勿使用液體、噴霧清潔劑或濕布進行清潔。
- 注意防潮，請勿將水或其他液體潑灑到本產品上。
- 插槽與開口供通風使用，以確保本產品的操作可靠並防止過熱，請勿堵塞或覆蓋開口。
- 請勿將本產品置放於靠近熱源的地方。除非有正常的通風，否則不可放在密閉位置中。
- 請不要私自打開機殼，不要嘗試自行維修本產品，請由授權的專業人士進行此項工作。

### 限用物質含有情況標示聲明書

設備名稱：AXE5400 Tri-Band Wi-Fi 6E Router Equipment name		型號（型式）：Archer AXE75 Type designation (Type)				
單元 Unit	限用物質及其化學符號 Restricted substances and its chemical symbols					
	鉛 Lead (Pb)	汞 Mercury (Hg)	鎘 Cadmium (Cd)	六價鉻 Hexavalent chromium (Cr <sup>6+</sup> )	多溴聯苯 Polybrominated biphenyls (PBB)	多溴二苯醚 Polybrominated diphenyl ethers (PBDE)
PCB	○	○	○	○	○	○
外殼	○	○	○	○	○	○
電源供應器	—	○	○	○	○	○
天線	○	○	○	○	○	○
<p>備考1. “超出0.1 wt %” 及 “超出0.01 wt %” 係指限用物質之百分比含量超出百分比含量基準值            Note 1: “Exceeding 0.1 wt %” and “exceeding 0.01 wt %” indicate that the percentage content of the restricted substance exceeds the reference percentage value of presence condition.</p> <p>備考2. “○” 係指該項限用物質之百分比含量未超出百分比含量基準值。            Note 2: “○” indicates that the percentage content of the restricted substance does not exceed the percentage of reference value of presence.</p> <p>備考3. “—” 係指該項限用物質為排除項目。            Note 3: The “—” indicates that the restricted substance corresponds to the exemption.</p>						



Продукт сертифіковано згідно с правилами системи УкрСЕПРО на відповідність вимогам нормативних документів та вимогам, що передбачені чинними законодавчими актами України.











### Safety Information

- Keep the device away from water, fire, humidity or hot environments.

- Do not attempt to disassemble, repair, or modify the device. If you need service, please contact us.
- Do not use damaged charger or USB cable to charge the device.
- Do not use any other chargers than those recommended
- Do not use the device where wireless devices are not allowed.
- Adapter shall be installed near the equipment and shall be easily accessible.
- Use only power supplies which are provided by manufacturer and in the original packing of this product. If you have any questions, please don't hesitate to contact us.
- Operating Temperature: 0°C ~ 40°C (32°F ~ 104°F)
- This product uses radios and other components that emit electromagnetic fields. Electromagnetic fields and magnets may interfere with pacemakers and other implanted medical devices. Always keep the product and its power adapter more than 15 cm (6 inches) away from any pacemakers or other implanted medical devices. If you suspect your product is interfering with your pacemaker or any other implanted medical device, turn off your product and consult your physician for information specific to your medical device.

Please read and follow the above safety information when operating the device. We cannot guarantee that no accidents or damage will occur due to improper use of the device. Please use this product with care and operate at your own risk.

## Explanations of the symbols on the product label

Symbol	Explanation
	DC voltage
	AC voltage
	Class II equipment
	Polarity of output terminals
	Energy efficiency Marking
	Indoor use only
	Caution
	Operator's manual

Symbol	Explanation
 The image shows the standard WEEE (Waste Electrical and Electronic Equipment) recycling symbol. It consists of a square with a diagonal cross (an 'X') inside, and a small circle at the bottom center. Below the square is a thick horizontal black bar.	<p data-bbox="414 241 1369 273"><b>RECYCLING</b></p> <p data-bbox="414 273 1369 399">This product bears the selective sorting symbol for Waste electrical and electronic equipment (WEEE). This means that this product must be handled pursuant to European directive 2012/19/EU in order to be recycled or dismantled to minimize its impact on the environment.</p> <p data-bbox="414 399 1369 472">User has the choice to give his product to a competent recycling organization or to the retailer when he buys a new electrical or electronic equipment.</p>