

Installation Guide

Omada AX3000 Gigabit VPN Router



Note: The image may differ from the actual product.

- To ask questions, find answers, and communicate with TP-Link users or engineers, please visit <https://community.tp-link.com> to join TP-Link Community.
- For technical support and other information, please visit <https://www.tp-link.com/support>, or simply scan the QR code.

© 2023 TP-Link 7106510233 REV1.0.0

1 Hardware Overview

Front Panel

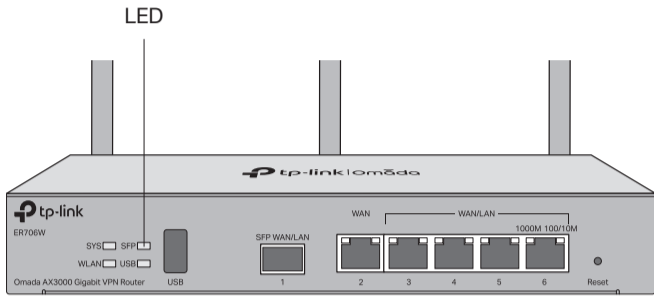

Back Panel

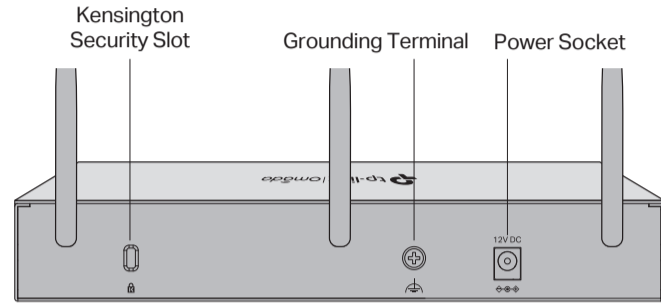

- Reset:** Press and hold the button for 5 seconds, the SYS LED will flash quickly, indicating the device is being reset to its factory default settings.

Interface	Description
USB	USB 3.0 for USB modem and USB storage device.
SFP WAN/LAN	Gigabit SFP WAN/LAN port connecting to an SFP module. By default, it is a WAN port. You can configure it to a LAN port on the management page.
WAN	Gigabit RJ45 WAN port.
WAN/LAN (Ports 3-6)	Gigabit RJ45 WAN/LAN ports. By default, they are LAN ports connecting to local PCs or switches. You can configure each port to a WAN port on the management page.
Kensington Security Slot	Secure the lock (not provided) into the security slot to prevent the device from being stolen.
Grounding Terminal	The router comes with a lightning protection mechanism.
Power Socket	Connect to the power outlet via the provided power adapter.

LED	Indication
SYS	Slow Flashing: System is running normally. Quick Flashing: The router is being reset. On/Off: System is starting up or running abnormally.
WLAN	On: Wireless networking is enabled. Off: Wireless networking is disabled.
SFP	On: Running at 1000 Mbps, but no activity. Off: No device is linked to the corresponding port. Flashing: Running at 1000 Mbps, and transmitting or receiving data.
USB	For USB Modem: Flashing: A modem is connected, and it is initializing. On: The modem is loaded. Off: No modem is inserted, or it is corrupted or incompatible. For USB Storage: On: A USB storage device is inserted and identified. Off: No USB storage device is inserted, or it is corrupted or incompatible.
Link/Act	Green On: Running at 1000 Mbps, but no activity. Green Flashing: Running at 1000 Mbps, and transmitting or receiving data. Green Off: Not running at 1000 Mbps, or no device is connected to the corresponding port. Yellow On: Running at 100/10 Mbps, but no activity. Yellow Flashing: Running at 100/10 Mbps, and transmitting or receiving data. Yellow Off: Not running at 100/10 Mbps, or no device is connected to the corresponding port.

2 Hardware Connection

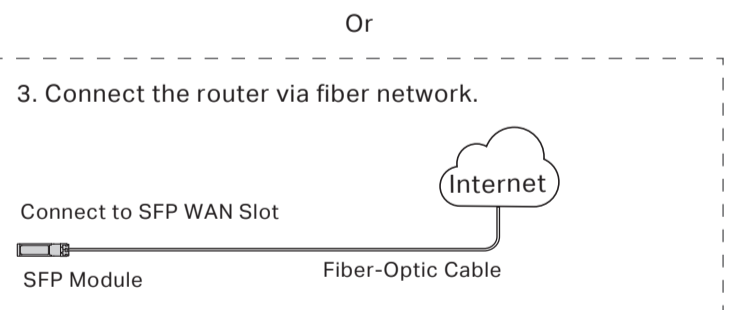
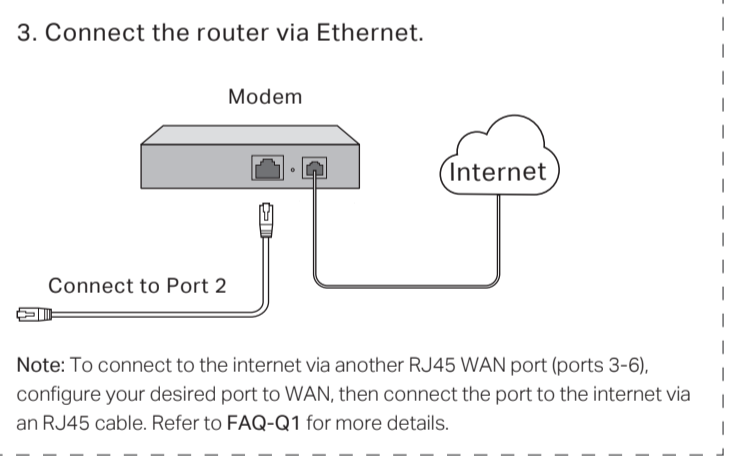
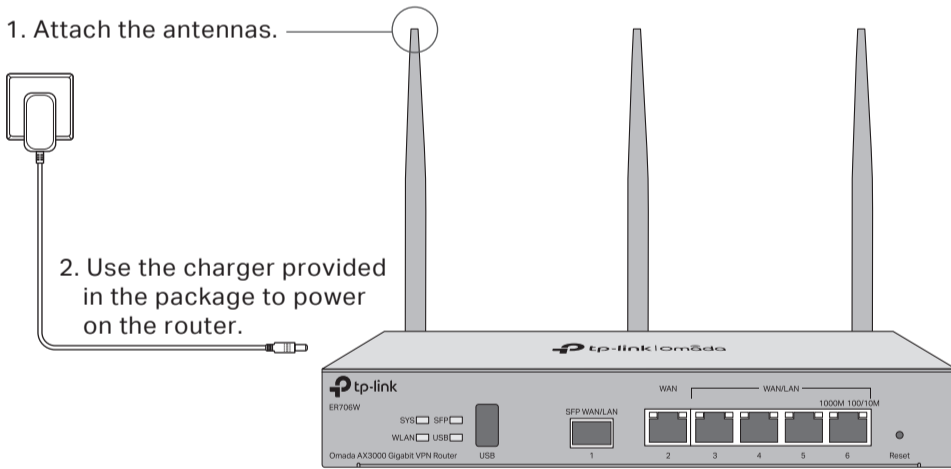

4. Wait until the SYS LED flashes slowly and the WLAN LED turns solid, indicating the router is ready for setup.

SYS Slow Flashing WLAN Solid On

3 Software Configuration

The router supports two configuration options:

- Standalone Mode:** Configure and manage the router by itself.
- Controller Mode:** Configure and manage network devices centrally. It is recommended in large-scale networks, which consist of a large number of devices such as access points, switches, and gateways.

Note:
1. When the router is managed by a controller, configurations of the router will be overridden by the controller.
2. For the detailed configurations, refer to the User Guide of the router and the controller. The guides can be found on the download center of our official website: <https://www.tp-link.com/support/download/>.

Option 1: Standalone Mode



Wireless Internet Connection



Wired Internet Connection



Via Omada App (Wireless Connection Only)

1. Download the TP-Link Omada App on your mobile device. It can be downloaded from App Store or Google Play:



2. Connect your mobile device to the router by using the default SSIDs printed on the label at the bottom of the product.
3. Open the Omada App, and wait for the router to appear on the **Standalone Devices > Gateways** page. Tap on your desired router to start the configuration.

Note: When configuring the router, make sure the ports you select as WAN ports correspond to the real situation.

The Omada App is designed to help you quickly configure the common settings. If you want to configure advanced settings, use the web page of your router or use Controller Mode.

Option 2: Controller Mode

Note: Omada Controller must have network access to your Omada devices in order to find, adopt, and manage them.

• Type 1: Via Omada Hardware Controller

The Omada Hardware Controller (e.g., OC200/OC300, purchased separately) is a good alternative if you have no spare PC to run the Omada Software Controller. For more details, refer to the Installation Guide of your Omada Hardware Controller.

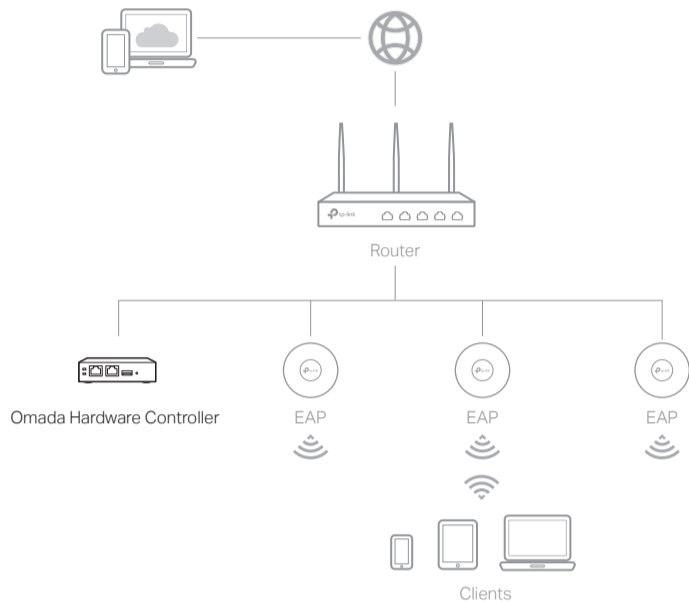

Via Omada App

1. Download the TP-Link Omada App on your mobile device. It can be downloaded from App Store or Google Play:



2. Launch your Omada App and configure the controller at a local site or remote site.

Local Management

- a. Connect your mobile device to the router by using the default SSID printed on the label at the bottom of the product.
- b. Launch Omada App and go to **Local Access**, tap the + button on the upper-right corner to add the controller. Then you can further configure the network.

Remote Management

Note: Before you start, make sure that both your controller and mobile device can access the internet.

- a. Make sure that **Cloud Access** is enabled on your controller. By default, **Cloud Access** is enabled. Make sure that the Cloud LED is flashing slowly.
- b. Launch Omada App and log in with your TP-Link ID. Then go to **Cloud Access**. Tap the + button on the upper-right to add your controller. Then you can further configure the network.

Via Web Browser

1. As Omada Hardware Controller gets its IP address from the DHCP server of the router, we don't know its IP address explicitly. However, we can find it out on the router's DHCP client list.

- a. Use a PC (make sure it is set to **Obtain an IP address automatically**) to find the IP address of the router. Open the command line on your PC and enter **ipconfig**. In the result list, find the **Default Gateway**, which is also the IP address of the router.
- b. Launch a web browser and enter the IP address of the router. Create a username and password, and log in to the router's web page. Then go to **Network > LAN > DHCP Client List** to find the IP address of your controller according to its MAC address.
- c. Enter the IP address of your controller in the address bar to open its web page.

2. On the Omada Controller's web page, follow the wizard to complete the quick setup.

Note: When configuring the router, make sure the ports you select as WAN ports correspond to the real situation.

3. After the quick setup, the login page appears. Enter the username and password you have created and click **Log in**. Then you can further configure the network.

4. **(For Remote Management)** You can remotely access and manage your controller via Omada Cloud Service.

- a. Make sure that **Cloud Access** is enabled on your controller. By default, **Cloud Access** is enabled. Make sure that the Cloud LED is flashing slowly.
- b. Launch a web browser and enter <https://omada.tplinkcloud.com> in the address bar. Enter your TP-Link ID and password to log in. Click + **Add Controller** and choose **Hardware Controller** to add your controller. Then you can further configure the network.

Frequently Asked Questions (FAQ)

Q1. What should I do if I want to change the mode of the WAN/LAN ports?

Follow the steps:

1. (Recommended) Refer to the Interface Description table of this guide for the default mode of the WAN/LAN ports.
2. Connect a computer to a LAN port of this router. If your computer is configured with a fixed IP address, change it to **Obtain an IP address automatically**.
3. Log in to this router's management page at <http://192.168.0.1>. Go to **Network > WAN > WAN Mode**, change the mode of the WAN/LAN ports by ticking the checkboxes, and click **Save**.

Q2. What should I do if I need to connect this router to a modem router?

Check the LAN IP address of the modem router first. If the LAN IP address of the modem router is 192.168.0.1, which is the same as the default LAN IP address of this router, follow the steps to change the LAN IP address of this router:

1. Connect a computer to a LAN port of this router. If your computer is configured with a fixed IP address, change it to **Obtain an IP address automatically**.
2. Log in to this router's management page at <http://192.168.0.1>, and go to **Network > LAN > LAN**. In the **Network List** section, change the IP address **192.168.0.1** to **192.168.1.1**, and click **OK**.

Via Web Browser

1. Connect your device to the router (wired or wireless).

Note: If your computer is configured with a fixed IP, change it to **Obtain an IP address automatically**.

Wired

Turn off the Wi-Fi on your computer and connect to a LAN port of the router with an RJ45 cable.

Wireless

- a. Find the SSID (network name) printed on the label at the bottom of the router.
- b. Click the network icon of your computer or go to Wi-Fi settings of your smart device, and then select the SSID to join the network.

2. Log in to the router.

- a. Launch a web browser, and enter <http://tplinker.net> or <http://192.168.0.1> in the address bar.
- b. Create a username and a password for subsequent login attempts and for security.
- c. Use the username and password set above to log in to the webpage.

3. After a successful login, you can configure the functions by clicking the setup menu on the left side of the screen.

Note: Make sure the ports you select as WAN ports correspond to the real situation.

• Type 2: Via Omada Software Controller

The Omada Software Controller is free software for centralized management. To centrally manage your devices, the Omada Software Controller needs to continually run on your computer.

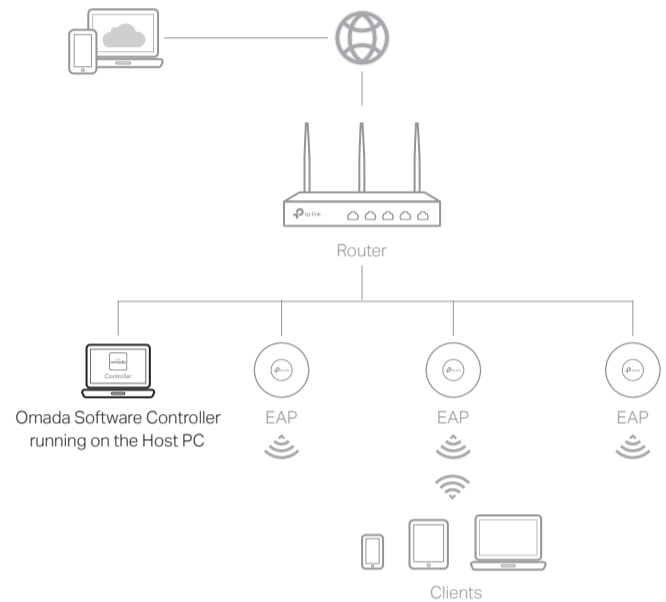

Via Omada App

1. Download the TP-Link Omada App on your mobile device. It can be downloaded from App Store or Google Play:



2. Launch your Omada App and configure the controller at a local site or remote site.

Local Management

- a. Connect your mobile device to the router by using the default SSID printed on the label at the bottom of the product.
- b. Launch Omada App and go to **Local Access**, tap the + button on the upper-right corner to add the controller. Then you can further configure the network.

Remote Management

Note: Before you start, make sure that both your controller and mobile device can access the internet.

- a. Make sure that **Cloud Access** is enabled on your controller and your controller has been bound with your TP-Link ID.
- b. Launch Omada App and log in with your TP-Link ID. Then go to **Cloud Access**. A list of controllers that have been bound with your TP-Link ID will appear. Then you can further configure the network.

Via Web Browser

1. On a PC with Windows OS or Linux OS, download the Omada Software Controller installation file from <https://www.tp-link.com/support/download/omada-software-controller/>.

Note: To download Omada Software Controller successfully, it is recommended to configure the router's network to access the internet. Refer to Standalone Mode to launch the web management page of the router, and go to **Network > WAN** to complete the configuration.

2. Run the file and follow the wizard to install the Omada Software Controller.
3. Launch the Omada Software Controller and follow the step-by-step instructions to complete the quick setup.

Note: When configuring the router, make sure the ports you select as WAN ports correspond to the real situation.

4. After the quick setup, the login page appears. Enter the username and password you created and click **Log in**. Then you can further configure the network.

Omada Cloud Portal

After installing Omada Software Controller, you can remotely access the controller through Omada Cloud Portal. Follow the steps below.

- a. Enable **Cloud Access** on the setting page on the controller and bind a TP-Link ID to your controller. If you have configured this in the setup wizard, skip the step.
- b. Launch a web browser and enter <https://omada.tplinkcloud.com> in the address bar.
- c. Enter your TP-Link ID and password to log in. A list of controllers that have been bound with your TP-Link ID will appear. Then you can click **Launch** to further configure the network.

Safety Information

- Keep the device away from water, fire, humidity or hot environments.
- Do not attempt to disassemble, repair, or modify the device. If you need service, please contact us.
- Do not use the device where wireless devices are not allowed.
- Do not use damaged charger or USB cable to charge the device.
- Do not use any other chargers than those recommended.
- Adapter shall be installed near the equipment and shall be easily accessible.
- Place the device with its bottom surface downward.

EU Declaration of Conformity

TP-Link hereby declares that the device is in compliance with the essential requirements and other relevant provisions of directives 2014/53/EU, 2009/125/EC, 2011/65/EU and (EU) 2015/863.

The original EU declaration of conformity may be found at <https://www.tp-link.com/en/support/ce/>.

UK Declaration of Conformity

TP-Link hereby declares that the device is in compliance with the essential requirements and other relevant provisions of the Radio Equipment Regulations 2017.

The original UK declaration of conformity may be found at <https://www.tp-link.com/support/ukca/>.

