



EN

DE

ES

FR

IT

NL

PT

Quick Start Guide

Turret

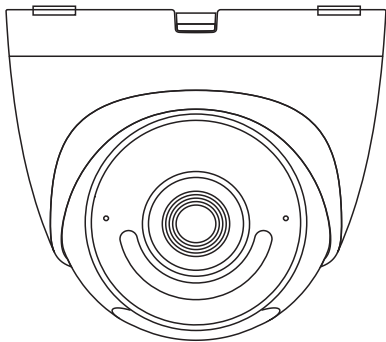

www.imoulife.com

Welcome

Thank you for choosing IMOJ.

We are devoted to providing you easy smart home products.

If you have problems using the product, please contact our service team before returning your product.

Our service mail: service.global@imoulife.com

Frequently asked questions can be found at imoulife.com/support/help



Package content



Camera x1

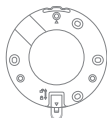

Mounting Plate x1

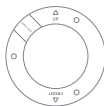

Positioning Map x1



Waterproof Connector x1

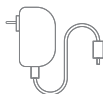

Power Adapter x1



Screw Package x1



Quick Start Guide x1

Camera introduction

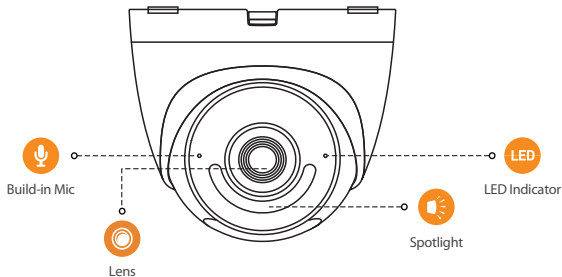

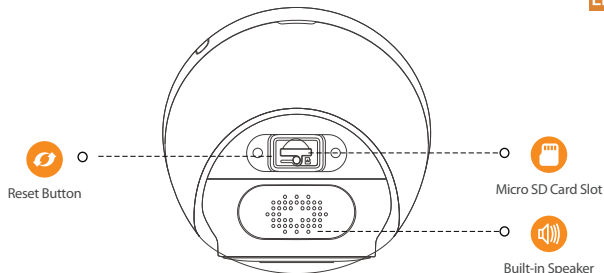

Note: Press and hold the reset button for 10 s to reset the camera.
Double-press the reset button to enable the camera hotspot.

The pattern of the LED indicator is included in the following table.

LED Indicator Status	Device Status
Off	<ul style="list-style-type: none"> ● Powered off/LED turned off ● Rebooting after reset
Red light on	<ul style="list-style-type: none"> ● Booting ● Device malfunction
Green light flashing	<ul style="list-style-type: none"> ● Waiting for network ● Enter Pairing mode
Green light on	<ul style="list-style-type: none"> ● Operating properly
Red light flashing	<ul style="list-style-type: none"> ● Network connection failed ● Pairing failed
Green and red light flashing alternately	<ul style="list-style-type: none"> ● Firmware updating

1

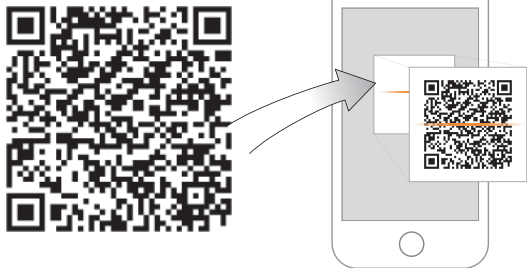

Imou Life

Download on the
App StoreGET IT ON
Google play

Windows

2

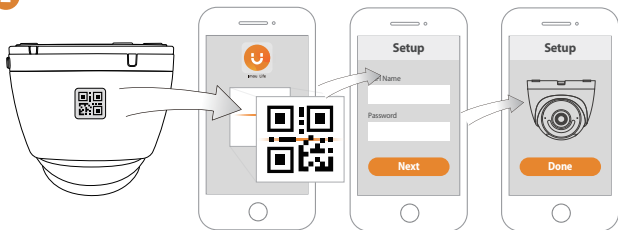

Ceiling Mounting

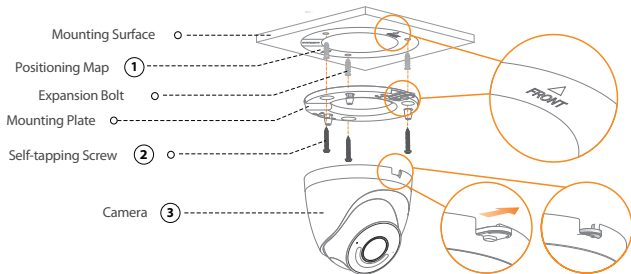

Adjusting Angle:

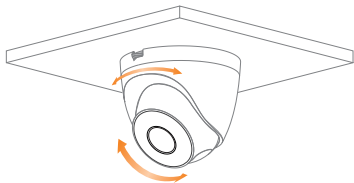

Wall Mount:

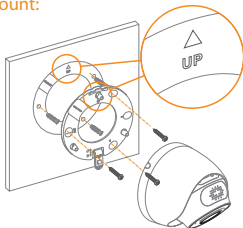

Problem	Solution
The camera cannot work normally or start	<ul style="list-style-type: none">• Make sure that the network cable is connected well, and the NVR or switch supports POE power supply. When the indicator light on the NVR or switch flashes, it means that the camera is powered up.
Where are the recorded videos saved	<ul style="list-style-type: none">• Scene1 Recorded videos are saved in NVR.• Scene2 When the Imou cloud is enabled, recorded videos are saved in Imou cloud.
The IR effect is not good	<ul style="list-style-type: none">• The infrared light is reflected to the lens, so the effect is not good. Adjust the lens angle to avoid occlusions around the lens.

Kurzanleitung

Turret

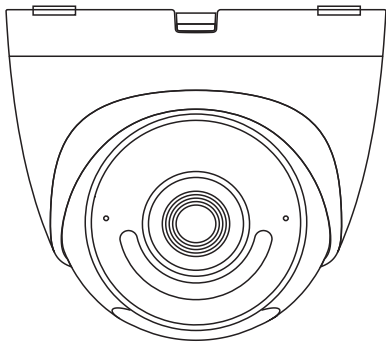

Willkommen

Vielen Dank, dass Sie sich für IMOUE entschieden haben. Wir sind bestrebt, einfachere Produkte für das intelligente Heim anzubieten. Wenn Sie Probleme bei der Verwendung des Produkts haben, wenden Sie sich bitte an unser Serviceteam.

Unsere Service-Mail lautet: service.global@imoulife.com

Häufig gestellte Fragen finden Sie unter imoulife.com/support/help



Packungsinhalt

DE



Kamera x1

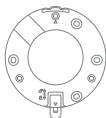

Montageschablone x1

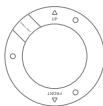

Montageschablone x1



Wasserdichter Anschluss x1

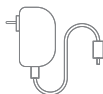

Netzteil x1



Schraubenbeutel x1



Kurzanleitung x1

Einführung in die Kamera

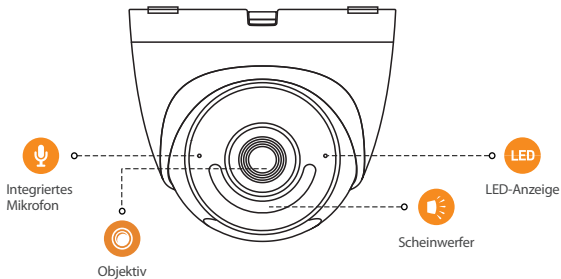

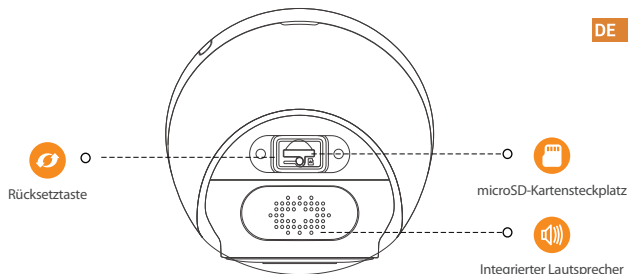

Hinweis:

Halten Sie die Rücksetz-/Kopplungstaste 10 Sekunden lang gedrückt, um die Kamera zurückzusetzen.

Doppelklick Sie die Reset-Taste, um den Kamera-Hotspot zu aktivieren.

The pattern of the LED indicator is included in the following table.

LED Status	Device Status
AUS	<ul style="list-style-type: none"> ● Abgeschaltet/LED Ausgeschaltet ● Gerät fährt nach Rücksetzung hoch
Rote LED leuchtet	<ul style="list-style-type: none"> ● Gerät fährt hoch ● Gerätestörung
Grüne LED blinkt	<ul style="list-style-type: none"> ● Warten auf ● Aktivieren den Pairing-Modus
Grüne LED leuchtet	<ul style="list-style-type: none"> ● Ordnungsgemäßer Betrieb
Rechte LED blinkt	<ul style="list-style-type: none"> ● Netzwerkverbindung fehlgeschlagen ● Pairing fehlgeschlagen
Grüne und rote LED blinken abwechselnd	<ul style="list-style-type: none"> ● Firmware-Update

1

DE

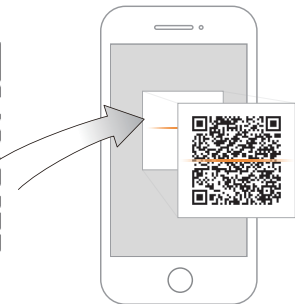

Imou Life



2

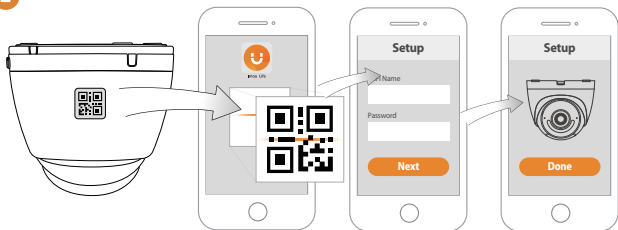

Deckenmontage

DE

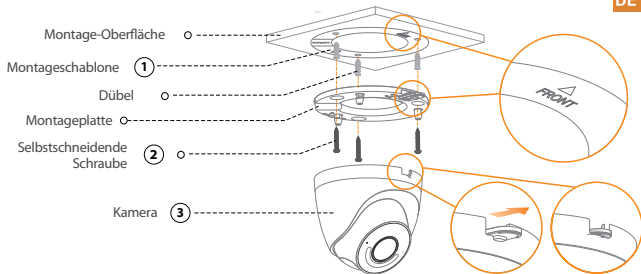

Einstellen des Blickwinkels:

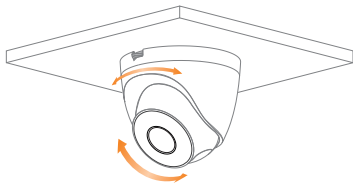

Wandmontage:

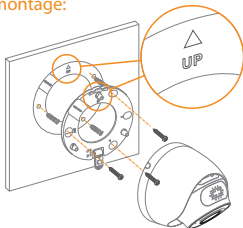

Fehlerbehebung

DE

Problem	Lösungen
Die Kamera funktioniert oder startet nicht ordnungsgemäß	<ul style="list-style-type: none">• Stellen Sie sicher, dass das Netzwerkkabel richtig angeschlossen ist und der NVR oder Switch Stromversorgung per POE unterstützt.
Wo werden die aufgezeichneten Videos gespeichert?	<ul style="list-style-type: none">• Szene1 Aufgezeichnete Videos werden auf dem NVR gespeichert.• Szene2 Wenn die Imou-Cloud aktiviert ist, werden aufgezeichnete Videos in der Imou-Cloud gespeichert.• Szene3 Das Infrarotlicht wird zum Objektiv reflektiert, sodass die Wirkung nicht gut ist. Stellen Sie den Objektivwinkel ein, um Reflexionen um die Linse herum zu vermeiden.
Die IR-Wirkung ist nicht gut	<ul style="list-style-type: none">• Das Infrarotlicht wird zum Objektiv reflektiert, sodass die Wirkung nicht gut ist. Stellen Sie den Objektivwinkel ein, um Reflexionen um die Linse herum zu vermeiden.

Guía de inicio rápido

Turret

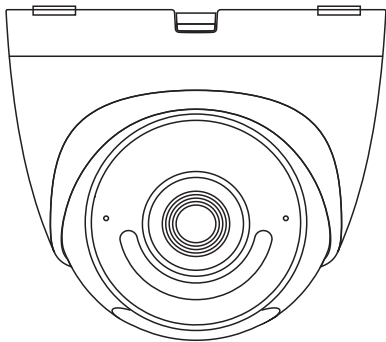

Bienvenido

ES

Gracias por elegir IMOU

Nuestra misión es proporcionar productos fáciles de usar para un hogar inteligente. Si tiene problemas usando el producto, por favor dirijase a nuestro equipo de atención al cliente antes de devolver su producto.

Nuestro correo electrónico de servicio:
service.global@imoulife.com

Nos comprometemos a contestarle en 24 horas.

Puede encontrar respuesta a las preguntas más frecuentes en
imoulife.com/support/help



Contenido del paquete



Cámara x1

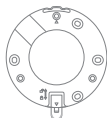

Placa de montaje x1

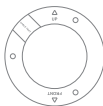

Plantilla de
posicionamiento x1



Conector a prueba
de agua x1

ES

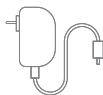

Alimentador x1



Juego de tornillos x1



Guía de inicio rápido x1

Introducción a la cámara

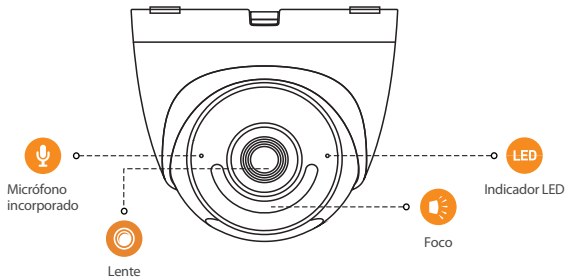

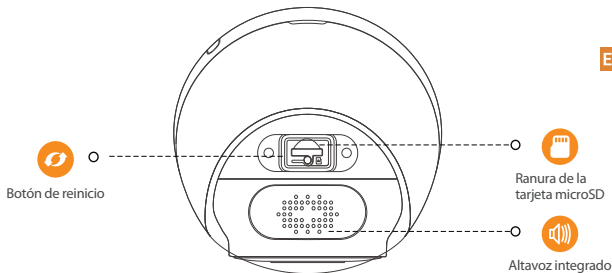
**Nota:**

Mantenga pulsado el botón de reinicio/emparejamiento durante 10 segundos para reiniciar la cámara.

Pulse dos veces el botón de reset para activar el hotspot de la cámara.

The pattern of the LED indicator is included in the following table.

Estado LED	Estado del aparato
APAGADA	<ul style="list-style-type: none"> ● Apagada/LED apagada ● Nuevo arranque después del reinicio
Luz roja encendida	<ul style="list-style-type: none"> ● Arranque ● Avería del dispositivo
Luz verde parpadeante	<ul style="list-style-type: none"> ● En espera de la red ● Entre en el modo de emparejamiento.
Luz verde encendida	<ul style="list-style-type: none"> ● Funcionando correctamente
Luz derecha parpadeante	<ul style="list-style-type: none"> ● Fallo de conexión de red ● Error de emparejamiento
Luz verde y luz roja parpadeando alternativamente	<ul style="list-style-type: none"> ● Actualización de firmware

1

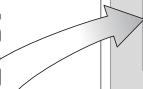

ES



Imou Life



Download on the
App Store



GET IT ON
Google play



Windows

2

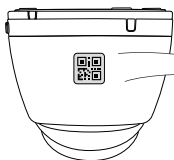

Montaje en el techo

ES

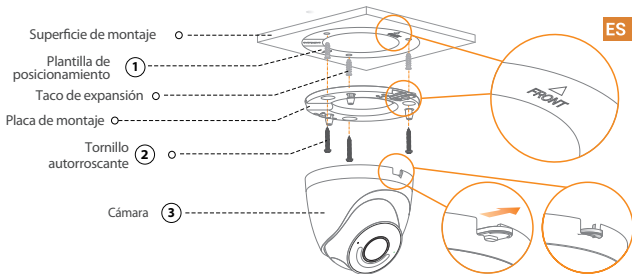

Ángulo de ajuste:

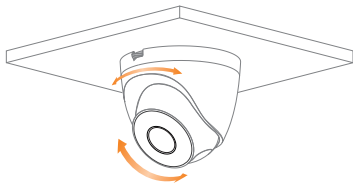

Montaje mural:

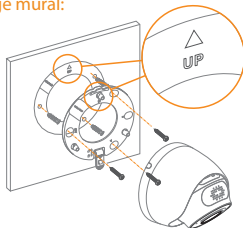

Solución de problemas

Problema	Solución
La cámara no funciona con normalidad o no se inicia	<ul style="list-style-type: none">• Asegúrese de que el cable de red esté bien conectado y que el NVR o el interruptor acepten la alimentación POE.
¿Dónde se guardan los videos grabados?	<ul style="list-style-type: none">• Escena1 Los videos grabados se guardan en el NVR.• Escena2 Cuando la nube Imou se activa, los videos grabados se guardan en ella.• Escena3 L luz infrarroja se refleja en la lente, por lo que el efecto no es bueno. Ajuste el ángulo de la lente para evitar oclusiones alrededor de la lente.
El efecto IR no es bueno	<ul style="list-style-type: none">• L luz infrarroja se refleja en la lente, por lo que el efecto no es bueno. Ajuste el ángulo de la lente para evitar oclusiones alrededor de la lente.

Guide de démarrage rapide

Turret

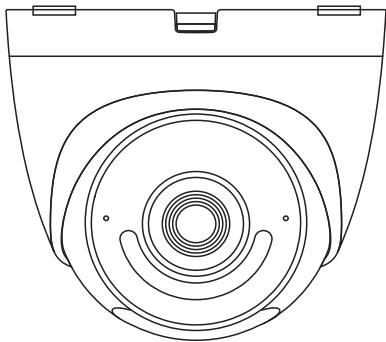

Bienvenue

FR

Merci d'avoir choisi IMOU.

Nous nous consacrons à fournir des produits pour la maison intelligente plus faciles à utiliser. Si vous rencontrez des difficultés lors de l'utilisation du produit, veuillez contacter notre équipe technique avant de renvoyer votre produit.

Notre courriel de service : service.global@imoulife.com

Nous nous engageons à vous répondre dans les 24 heures.

Les questions les plus fréquemment posées peuvent être consultées sur le site imoulife.com/support/help



Contenu de l'emballage



Caméra x1

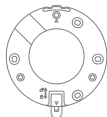

Plaque de montage x1

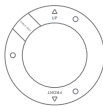

Patron d'installation x1



Connecteur étanche x1

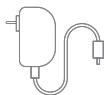

Adaptateur
d'alimentation x1



Jeu de vis x1



Guide de démarrage
rapide x1

Introduction à la caméra

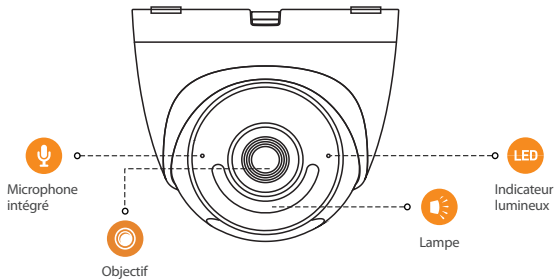

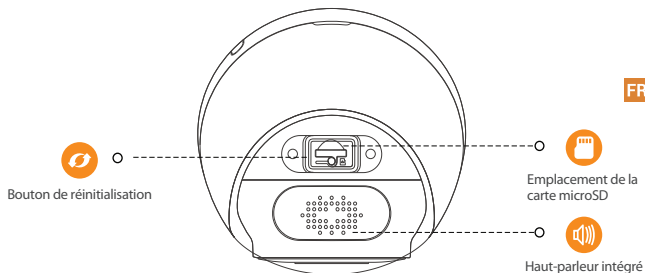

Remarque:

Appuyez et maintenez la touche de réinitialisation/couplage pendant 10 secondes pour réinitialiser la caméra.

Appuyez deux fois sur le bouton de réinitialisation pour activer le point d'accès de la caméra.

The pattern of the LED indicator is included in the following table.

Estado LED	Estado del aparato
APAGADA	<ul style="list-style-type: none"> ● Éteint/Voyant éteint ● Redémarrage après remise à zéro
Allumé en rouge	<ul style="list-style-type: none"> ● Amorçage ● Fonctionnement défectueux de l'appareil
Clignotant en vert	<ul style="list-style-type: none"> ● En attente de connexion réseau ● Entrer en mode d'appairage
Allumé en vert	<ul style="list-style-type: none"> ● Fonctionnement normal
Clignotement du voyant droit	<ul style="list-style-type: none"> ● Échec de connexion au réseau ● L'appairage a échoué
Voyant vert et voyant rouge clignotant en alternance	<ul style="list-style-type: none"> ● Mise à jour du micrologiciel

1

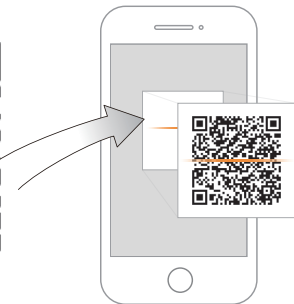

FR



2

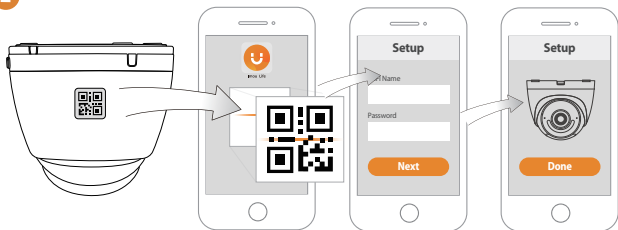

Montage au plafond

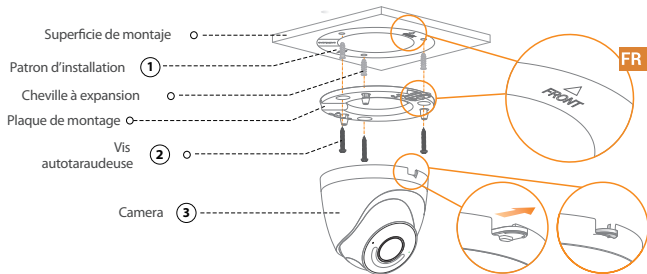

Réglage de l'angle:

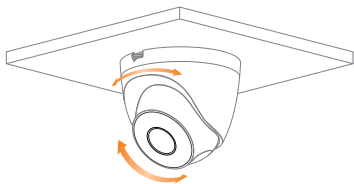

Montage mural:

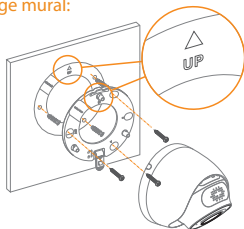

Dépannage

Problème	Solution
La caméra ne peut ni démarrer ni fonctionner normalement	<ul style="list-style-type: none">• Vérifiez que le câble réseau est bien connecté et que le NVR ou le commutateur prend en charge l'alimentation PoE.
Où sont stockées les vidéos enregistrées	<ul style="list-style-type: none">• Scène1 Les vidéos enregistrées sont stockées dans le NVR.• Scène2 Une fois le cloud Imou activé, les vidéos enregistrées y sont stockées.• Scène3 Le résultat n'est pas de bonne qualité car la lumière IR réfléchit sur l'objectif. Ajustez l'angle de l'objectif pour éviter les occultations autour de celui-ci.
L'effet IR n'est pas de bonne qualité	<ul style="list-style-type: none">• Le résultat n'est pas de bonne qualité car la lumière IR réfléchit sur l'objectif. Ajustez l'angle de l'objectif pour éviter les occultations autour de celui-ci.

Guida Rapida

Turret

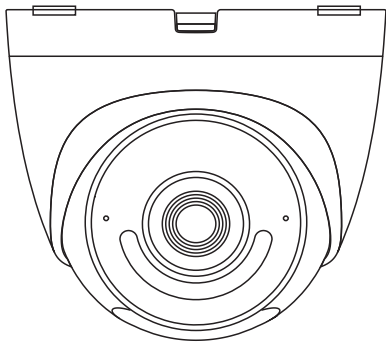

Benvenuti

IT

Grazie per aver scelto IMOU.

Il nostro obiettivo è quello di fornire prodotti per la domotica più facili da utilizzare. In caso di problemi durante l'utilizzo del prodotto, si prega di contattare il nostro team di assistenza prima di restituire il prodotto.

La nostra e-mail per il servizio di assistenza:
service.global@imoulife.com

Promettiamo di rispondere entro 24 ore.

Le risposte alle domande più frequenti sono disponibili all'indirizzo imoulife.com/support/help

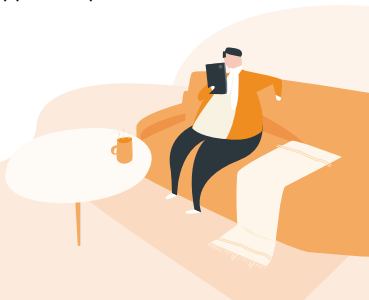

Contenuto della confezione



Telecamera x1

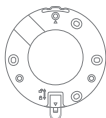

Piastra di montaggio x1

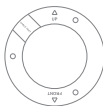

Dima di
posizionamento x1



IT

Waterdichte Connector x1

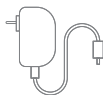

Alimentatore x1



Confezione di viti x1



Guida introduttiva x1

Introduzione alla telecamera

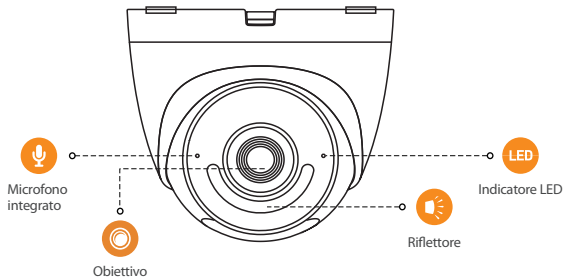

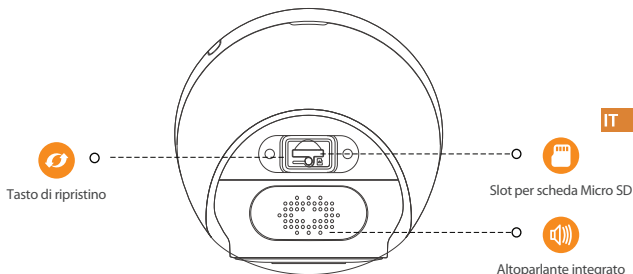
**Nota:**

Tenere premuto per 10 secondi il pulsante Reimposta/Associa per reimpostare la telecamera.
 Premere due volte il bottone di reset per abilitare l'hotspot della telecamera.

The pattern of the LED indicator is included in the following table.

Stato LED	Stato dispositivo
SPENTO	<ul style="list-style-type: none"> ● Spento/LED spento ● Riavvio dopo il ripristino
Luce rossa accesa	<ul style="list-style-type: none"> ● Avvio ● Malfunzionamento del dispositivo
Luce verde lampeggiante	<ul style="list-style-type: none"> ● In attesa di rete ● Accesso alla modalità accoppiamento
Luce verde accesa	<ul style="list-style-type: none"> ● Funzionamento normale
Luce rossa lampeggiante	<ul style="list-style-type: none"> ● Connessione di rete non riuscita ● Accoppiamento fallito
La luce verde e quella rossa lampeggiano in alternanza	<ul style="list-style-type: none"> ● Aggiornamento del firmware

1

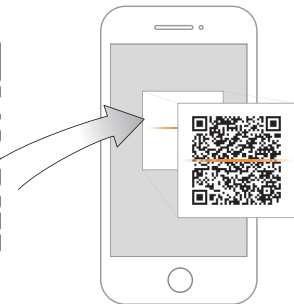

IT



Imou Life



2

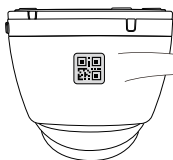

Montaggio a soffitto

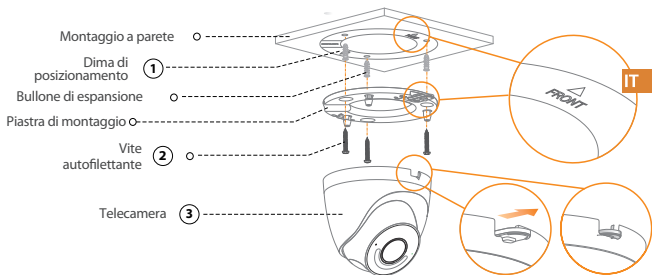

Regolazione dell'angolazione:

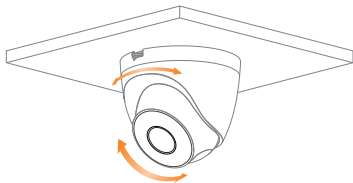

Montaggio a parete:

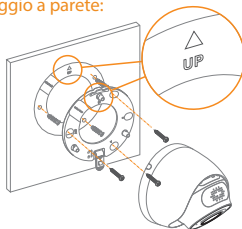

Risoluzione dei problemi

Problema	Soluzione
La telecamera non funziona o non si avvia normalmente	<ul style="list-style-type: none">• Accertarsi che il cavo di rete sia collegato in modo corretto e che l'NVR o lo switch supportino l'alimentazione POE.
Dove vengono salvati i video registrati	<ul style="list-style-type: none">• Scene1 I video registrati vengono salvati sull'NVR.• Scene2 I video vengono salvati sul cloud Imou se questo è attivo.• Scene3 La luce a infrarossi si riflette sull'obiettivo e il risultato non è buono. Per evitare occlusioni intorno all'obiettivo, regolarne l'angolo.
L'effetto IR non è buono	<ul style="list-style-type: none">• La luce a infrarossi si riflette sull'obiettivo e il risultato non è buono. Per evitare occlusioni intorno all'obiettivo, regolarne l'angolo.

Snelstartgids

Turret

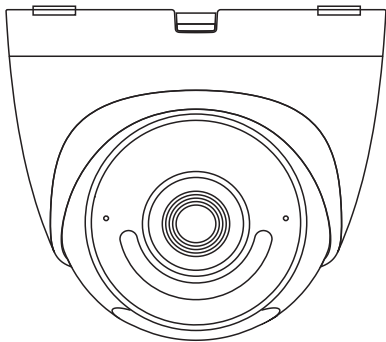

Welkom

Bedankt dat u voor Imou heeft gekozen.

NL

Onze toewijding is om u eenvoudige Smart Home producten te bieden. Als u problemen ervaart met het gebruik van uw product, neem dan eerst contact op met onze service team: service.global@imoulife.com

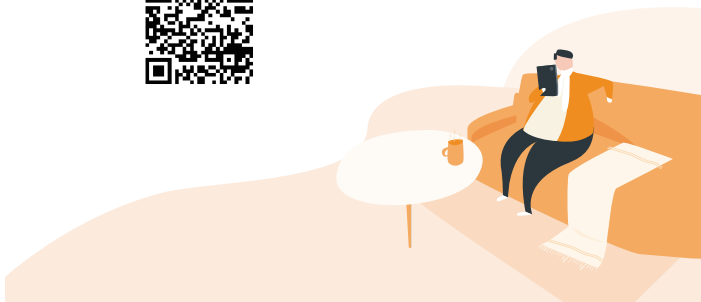

Inhoud verpakking



Camera x1

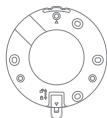

Montageplaat x1

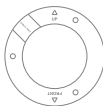

Montageoverzicht x1



Connettere impermeabile x1

NL

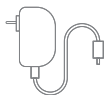

Voedingsadapter x1



Schroevenset x1



Snel startgids x1

Introductie camera

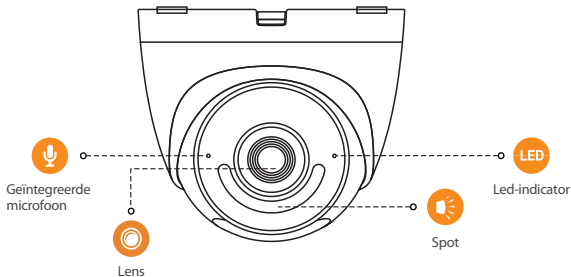

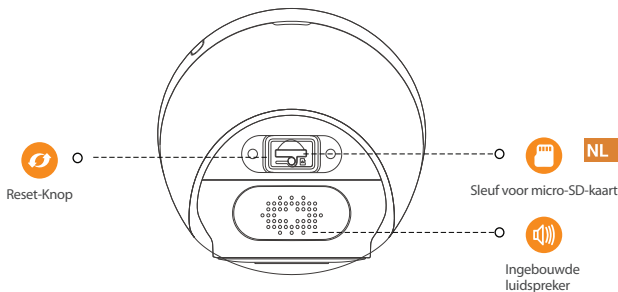

NL

Opmerking: Druk de reset-/koppelknop 10 seconden in om de camera te resetten.
Druk de resetknop 2x achter elkaar om de cameras hotspot te activeren.

The pattern of the LED indicator is included in the following table.

Ledstatus	Apparaatstatus
UIT	<ul style="list-style-type: none"> ● Uitgeschakeld/led uit ● Opnieuw opstarten na reset
Rood lampje aan	<ul style="list-style-type: none"> ● Bezigt met opstarten ● Storing van het apparaat
Groen lampje knippert	<ul style="list-style-type: none"> ● Wachten op netwerk ● Begin koppelingsmodus
Groen lampje aan	<ul style="list-style-type: none"> ● Werkt zoals dat moet
Rood lampje knippert	<ul style="list-style-type: none"> ● Netwerkverbinding mislukt ● Koppeling mislukt
Groen lampje en rood lampje knipperen afwisselend	<ul style="list-style-type: none"> ● Bijwerken firmware

1

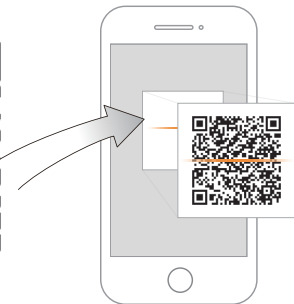

NL



2

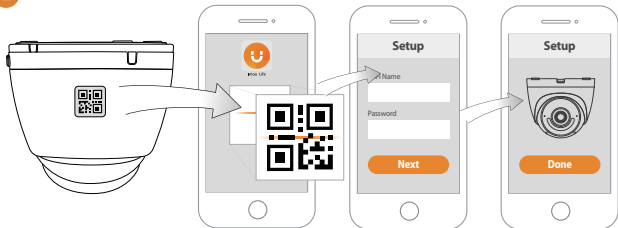

Plafondbevestiging

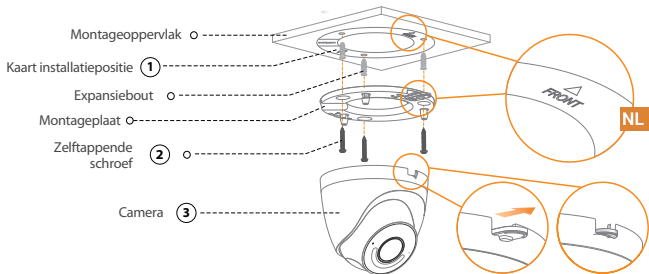

De hoek aanpassen:

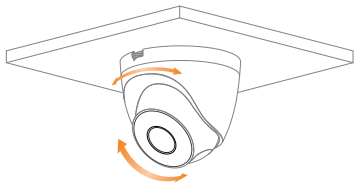

Wandmontage:

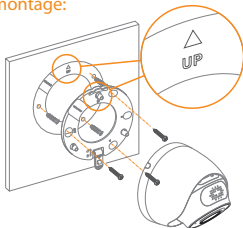

Probleemoplossing

Probleem	Oplossing
De camera kan niet normaal functioneren of opstarten	<ul style="list-style-type: none">• Zorg dat de netwerkkabel correct is aangesloten en dat de NVR of switch de POE-voeding ondersteunt.
Waar worden de opgenomen video's opgeslagen	<ul style="list-style-type: none">• Scène1 Opgenomen video's worden opgeslagen in NVR.• Scène2 Als de Imou-cloud is ingeschakeld, worden opgenomen video's opgeslagen in de Imou-cloud.• Scène3 Het infraroodlicht wordt weerkaatst op de lens, waardoor het effect niet goed is. Pas de lenshoek aan om occlusies rond de lens te voorkomen.
Het infraroodeffect is niet goed	<ul style="list-style-type: none">• Het infraroodlicht wordt weerkaatst op de lens, waardoor het effect niet goed is. Pas de lenshoek aan om occlusies rond de lens te voorkomen.

Guia rápido

Turret

PT

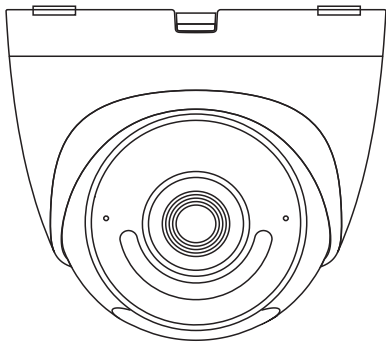

Bem-vindo

Obrigado por escolher a IMOU.

Estamos empenhados em fornecer produtos inteligentes e simplificados para o lar. Se tiver problemas ao utilizar o produto, contacte a nossa equipa de assistência antes de devolver o produto.

PT

O nosso e-mail de assistência: service.global@imoulife.com
Prometemos responder no prazo de 24 horas.

Pode encontrar as Perguntas frequentes em imoulife.com/support/help



Conteúdo da embalagem



Câmara x1

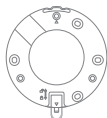

Placa de montagem x1

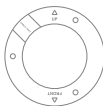

Mapa de
posicionamento x1



Conector
impermeável x1

PT

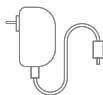

Adaptador
de energia x1



Pacote de parafusos x1



Snel startgids x1

Apresentação da câmara

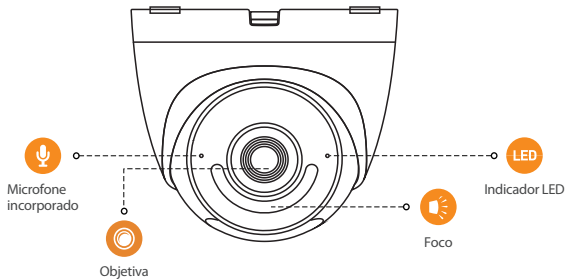

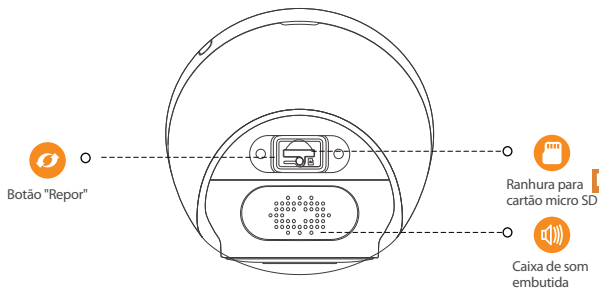

PT

Nota: Prima sem soltar o botão Reset/Pair durante 10 segundos para repor a câmara.
 Pressione duas vezes o botão de redefinição para ativar o ponto de acesso da câmara.

The pattern of the LED indicator is included in the following table.

Estado do LED	Estado do dispositivo
DESLIGADO	<ul style="list-style-type: none"> ● Desligado/LED desligado ● Reiniciar após a reposição
Luz vermelha acesa	<ul style="list-style-type: none"> ● Arranque ● Avaria do dispositivo
Luz verde intermitente	<ul style="list-style-type: none"> ● À espera da rede ● Entre no modo de emparelhamento
Luz verde acesa	<ul style="list-style-type: none"> ● A funcionar corretamente
Luz vermelha intermitente	<ul style="list-style-type: none"> ● Ligação à rede falhou ● Falha no emparelhamento
Luz verde e luz vermelha intermitentes alternadamente	<ul style="list-style-type: none"> ● Atualização do firmware

1

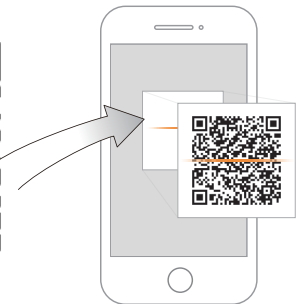

PT



Imou Life



Download on the
App Store



GET IT ON
Google play



Windows

2

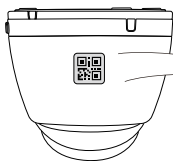

Montagem no teto

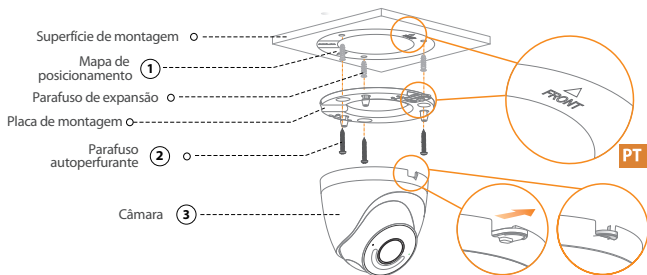

Ajustar o ângulo:

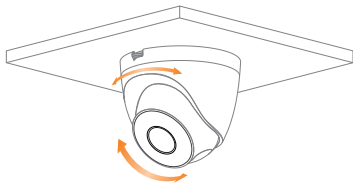

Montagem em parede:

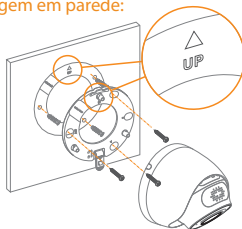

Solução de problema

Problema	Solução
A câmara não funciona normalmente ou não inicia	<ul style="list-style-type: none">• Certifique-se de que o cabo de rede está bem ligado, e se o NVR ou computador suporta a alimentação tipo POE.
Onde se encontram guardados os vídeos gravados	<ul style="list-style-type: none">• Cena1 Os vídeos gravados estão guardados no NVR.• Cena2 Quando a nuvem Imou está ativada, os vídeos gravados são guardados na nuvem Imou.• Cena3 A luz infravermelha é refletida na lente, por isso o efeito não é satisfatório. Ajuste o ângulo da lente para evitar oclusões em volta da lente.
O efeito de IV não é satisfatório	<ul style="list-style-type: none">• A luz infravermelha é refletida na lente, por isso o efeito não é satisfatório. Ajuste o ângulo da lente para evitar oclusões em volta da lente.

PT

imou

Enjoy Smart Life



CE FC CCC UL  ISO 9001:2000

 @imouglobal

 service.global@imoulife.com

 www.imoulife.com