



# Quick Start Guide

T22A

EN

DE

ES

FR

IT

NL

PT

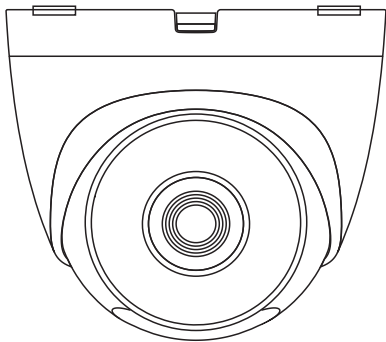

[www.imoulife.com](http://www.imoulife.com)

# Welcome

Thank you for choosing IMOJ.

We are devoted to providing you easy smart home products.

If you have problems using the product, please contact our service team before returning your product.

Our service mail: [service.global@imoulife.com](mailto:service.global@imoulife.com)

Frequently asked questions can be found at [imoulife.com/support/help](http://imoulife.com/support/help)



## Package content



Camera x1

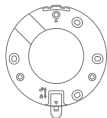

Mounting Plate x1

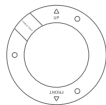

Positioning Map x1



Screw Package x1



Quick Start Guide x1

## Camera introduction

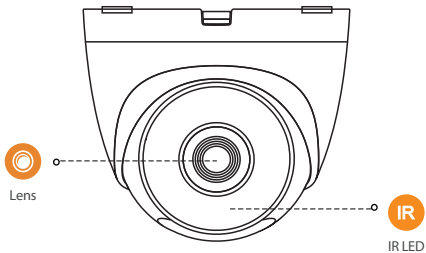

## Scene1:

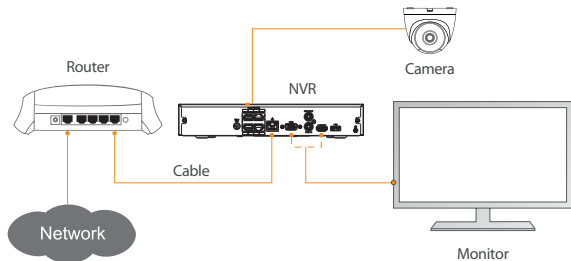

## Scene2:

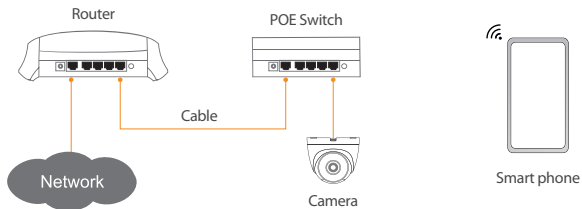

1

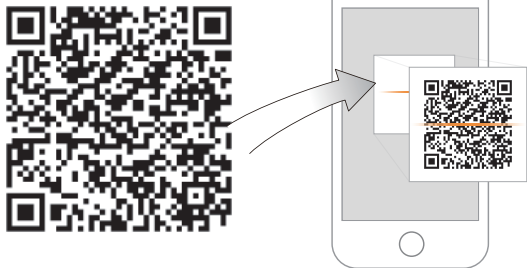
**Imou Life**Download on the  
App StoreGET IT ON  
Google play

Windows

2

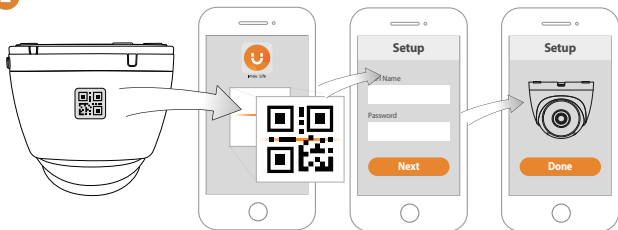

## Ceiling Mounting

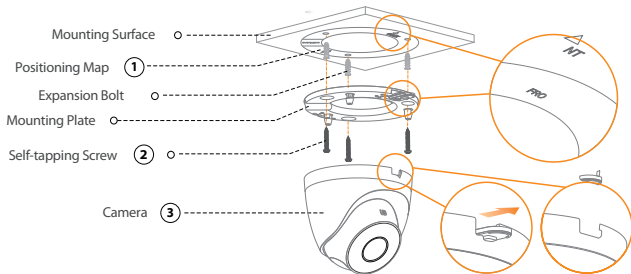

### Adjusting Angle:

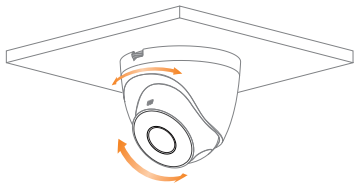

### Wall Mount:

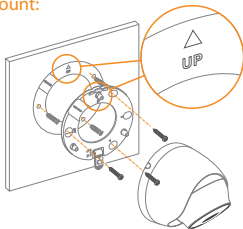

Problem	Solution
The camera cannot work normally or start	<ul style="list-style-type: none"><li>• Make sure that the network cable is connected well, and the NVR or switch supports POE power supply. When the indicator light on the NVR or switch flashes, it means that the camera is powered up.</li></ul>
Where are the recorded videos saved	<ul style="list-style-type: none"><li>• Scene1 Recorded videos are saved in NVR.</li><li>• Scene2 When the Imou cloud is enabled, recorded videos are saved in Imou cloud.</li></ul>
The IR effect is not good	<ul style="list-style-type: none"><li>• The infrared light is reflected to the lens, so the effect is not good. Adjust the lens angle to avoid occlusions around the lens.</li></ul>

# Kurzanleitung

## T22A

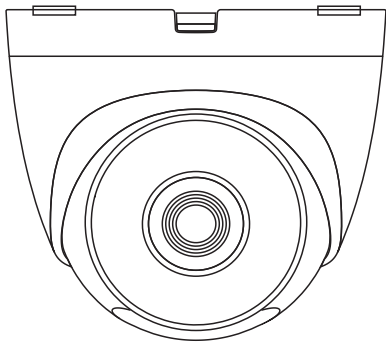



# Willkommen

Vielen Dank, dass Sie sich für IMOUE entschieden haben. Wir sind bestrebt, einfachere Produkte für das intelligente Heim anzubieten. Wenn Sie Probleme bei der Verwendung des Produkts haben, wenden Sie sich bitte an unser Serviceteam.

Unsere Service-Mail lautet: [service.global@imoulife.com](mailto:service.global@imoulife.com)

Häufig gestellte Fragen finden Sie unter [imoulife.com/support/help](https://imoulife.com/support/help)



## Packungsinhalt

DE



Kamera x1

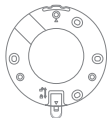

Wandarmadapter x1

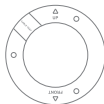

Bohrlochschaablone x1



Schrauben x1



Kurzanleitung x1

## Einführung in die Kamera

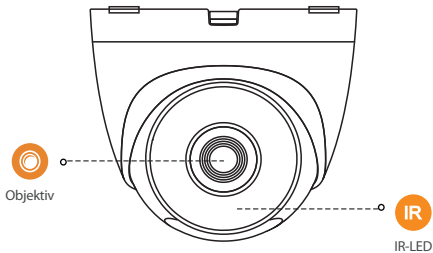

## Szene1:

DE

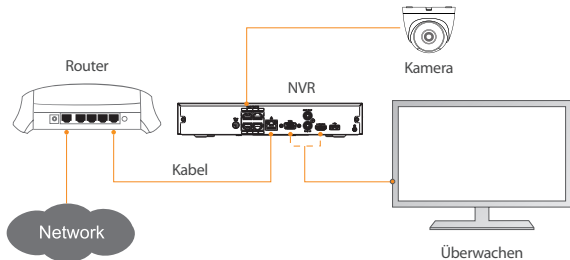

## Szene2:

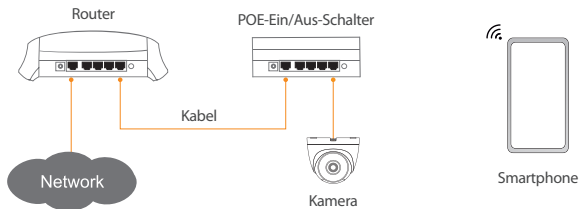

1

DE

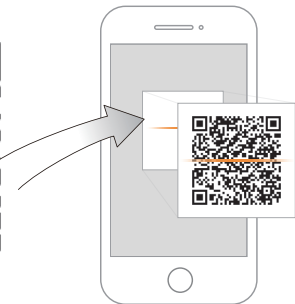

Imou Life



2

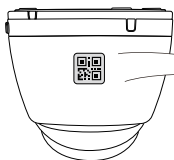

## Deckenmontage

DE

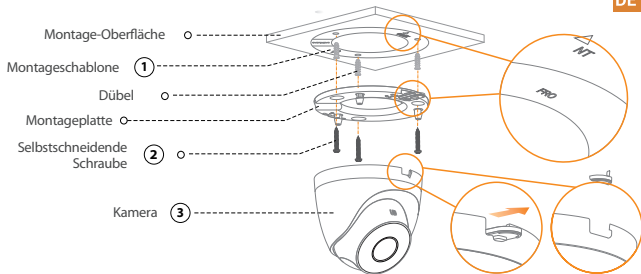

### Einstellen des Blickwinkels:

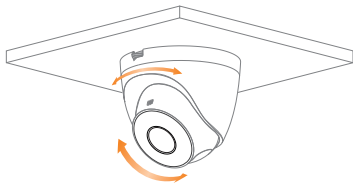

### Wandmontage:

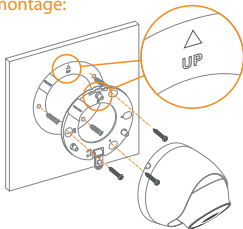

## Fehlerbehebung

DE

Problem	Lösungen
Die Kamera funktioniert oder startet nicht ordnungsgemäß	<ul style="list-style-type: none"><li>• Stellen Sie sicher, dass das Netzkabel richtig angeschlossen ist und der NVR oder Switch Stromversorgung per POE unterstützt.</li></ul>
Wo werden die aufgezeichneten Videos gespeichert?	<ul style="list-style-type: none"><li>• Szene1 Aufgezeichnete Videos werden auf dem NVR gespeichert.</li><li>• Szene2 Wenn die Imou-Cloud aktiviert ist, werden aufgezeichnete Videos in der Imou-Cloud gespeichert.</li><li>• Szene3 Das Infrarotlicht wird zum Objektiv reflektiert, sodass die Wirkung nicht gut ist. Stellen Sie den Objektivwinkel ein, um Reflexionen um die Linse herum zu vermeiden.</li></ul>
Die IR-Wirkung ist nicht gut	<ul style="list-style-type: none"><li>• Das Infrarotlicht wird zum Objektiv reflektiert, sodass die Wirkung nicht gut ist. Stellen Sie den Objektivwinkel ein, um Reflexionen um die Linse herum zu vermeiden.</li></ul>

# Guía de inicio rápido

## T22A

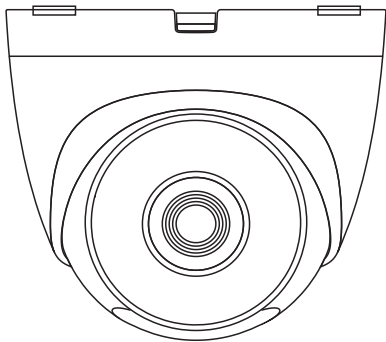

# Bienvenido

ES

Gracias por elegir IMOU

Nuestra misión es proporcionar productos fáciles de usar para un hogar inteligente. Si tiene problemas usando el producto, por favor diríjase a nuestro equipo de atención al cliente antes de devolver su producto.

Nuestro correo electrónico de servicio:  
[service.global@imoulife.com](mailto:service.global@imoulife.com)

Nos comprometemos a contestarle en 24 horas.

Puede encontrar respuesta a las preguntas más frecuentes en  
[imoulife.com/support/help](http://imoulife.com/support/help)





## Contenido del paquete



Cámara x1

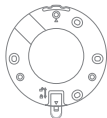

Placa de montaje x1

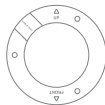

Plantilla de posicionamiento x1

ES



Bolsa con tornillosx1



Guía de inicio rápidox1

## Introducción a la cámara

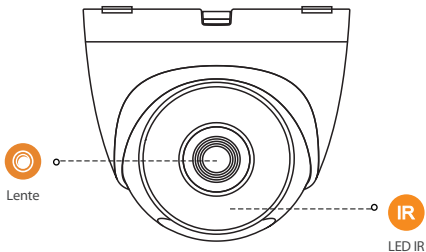

## Escena1:

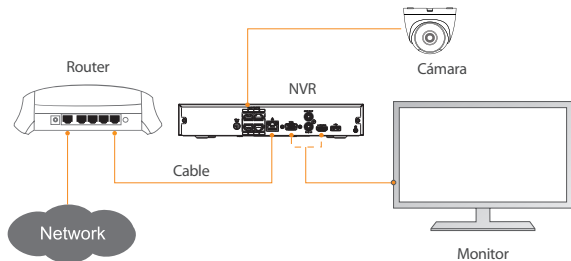

## Escena2:

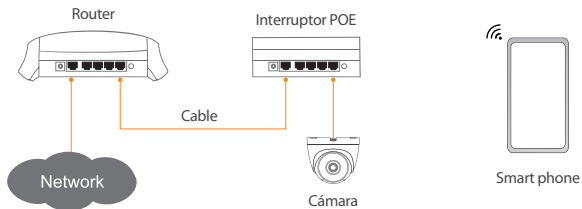

1

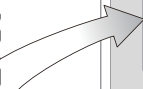

ES



Imou Life



Download on the  
App Store



GET IT ON  
Google play



Windows

2

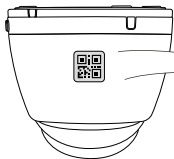

## Montaje en el techo

ES

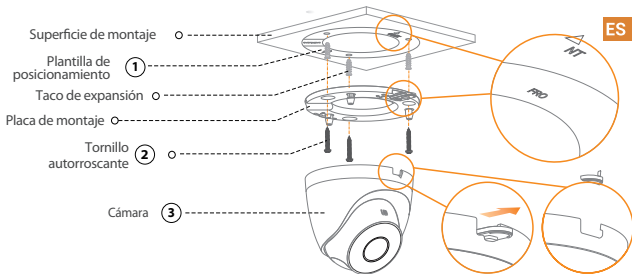

### Ángulo de ajuste:

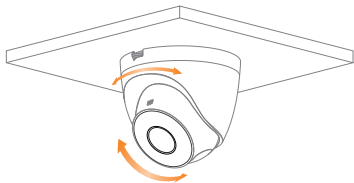

### Montaje mural:

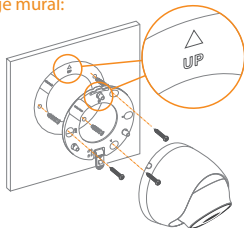

## Solución de problemas

Problema	Solución
La cámara no funciona con normalidad o no se inicia	<ul style="list-style-type: none"><li>• Asegúrese de que el cable de red esté bien conectado y que el NVR o el interruptor acepten la alimentación POE.</li></ul>
¿Dónde se guardan los videos grabados?	<ul style="list-style-type: none"><li>• Escena1 Los videos grabados se guardan en el NVR.</li><li>• Escena2 Cuando la nube Imou se activa, los videos grabados se guardan en ella.</li><li>• Escena3 L luz infrarroja se refleja en la lente, por lo que el efecto no es bueno. Ajuste el ángulo de la lente para evitar oclusiones alrededor de la lente.</li></ul>
El efecto IR no es bueno	<ul style="list-style-type: none"><li>• L luz infrarroja se refleja en la lente, por lo que el efecto no es bueno. Ajuste el ángulo de la lente para evitar oclusiones alrededor de la lente.</li></ul>

# Guide de démarrage rapide

T22A

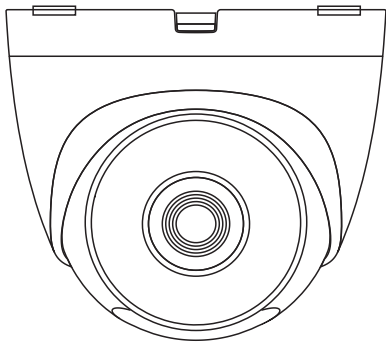

# Bienvenue

FR

Merci d'avoir choisi IMOU.

Nous nous consacrons à fournir des produits pour la maison intelligente plus faciles à utiliser. Si vous rencontrez des difficultés lors de l'utilisation du produit, veuillez contacter notre équipe technique avant de renvoyer votre produit.

Notre courriel de service : [service.global@imoulife.com](mailto:service.global@imoulife.com)

Nous nous engageons à vous répondre dans les 24 heures.

Les questions les plus fréquemment posées peuvent être consultées sur le site [imoulife.com/support/help](https://imoulife.com/support/help)



## Contenu de l'emballage



Camérazx1

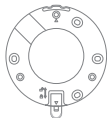

Mounting Plate x1

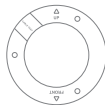

Patron d'installation x1

FR



Paquet de visx1



Guide de démarrage rapidex1

## Introduction à la caméra

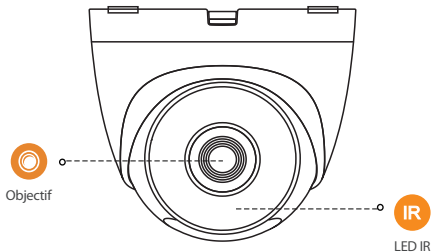



## Scène1:

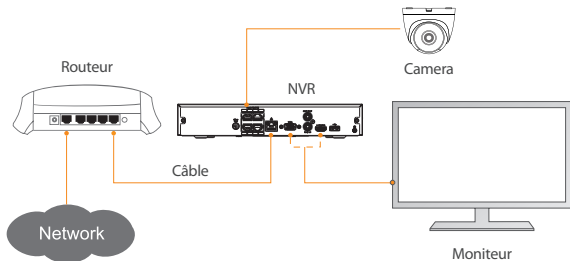

## Scène2:

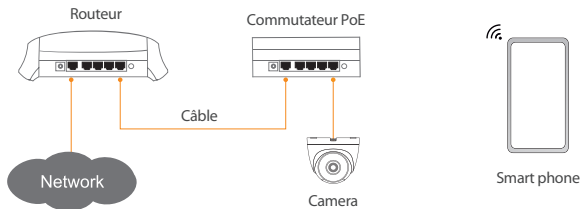

1

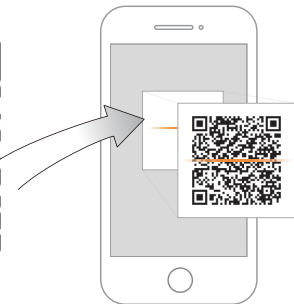

FR



2

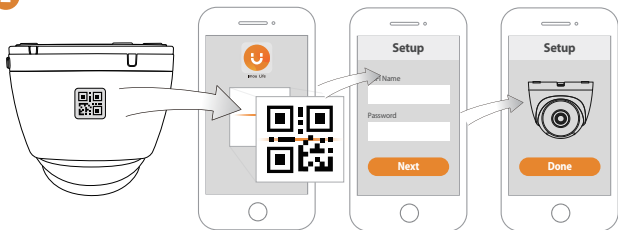

## Montage au plafond

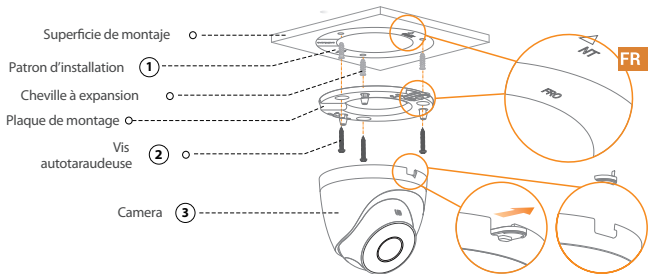

## Réglage de l'angle:

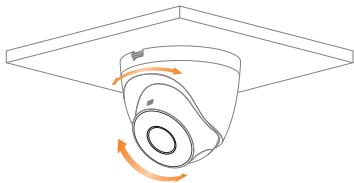

## Montage mural:

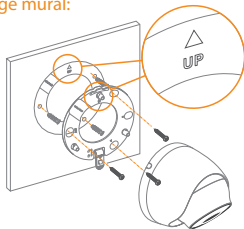

## Dépannage

Problème	Solution
La caméra ne peut ni démarrer ni fonctionner normalement	<ul style="list-style-type: none"><li>• Vérifiez que le câble réseau est bien connecté et que le NVR ou le commutateur prend en charge l'alimentation PoE.</li></ul>
Où sont stockées les vidéos enregistrées	<ul style="list-style-type: none"><li>• Scène1 Les vidéos enregistrées sont stockées dans le NVR.</li><li>• Scène2 Une fois le cloud Imou activé, les vidéos enregistrées y sont stockées.</li><li>• Scène3 Le résultat n'est pas de bonne qualité car la lumière IR réfléchit sur l'objectif. Ajustez l'angle de l'objectif pour éviter les occultations autour de celui-ci.</li></ul>
L'effet IR n'est pas de bonne qualité	<ul style="list-style-type: none"><li>• Le résultat n'est pas de bonne qualité car la lumière IR réfléchit sur l'objectif. Ajustez l'angle de l'objectif pour éviter les occultations autour de celui-ci.</li></ul>

# Guida Rapida

T22A

IT

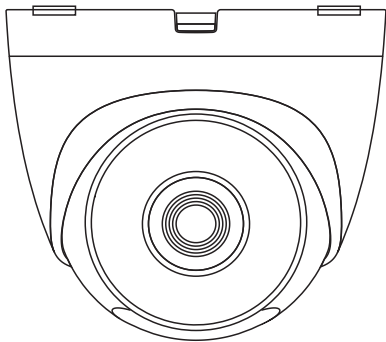

# Benvenuti

IT

Grazie per aver scelto IMOU.

Il nostro obiettivo è quello di fornire prodotti per la domotica più facili da utilizzare. In caso di problemi durante l'utilizzo del prodotto, si prega di contattare il nostro team di assistenza prima di restituire il prodotto.

La nostra e-mail per il servizio di assistenza:  
[service.global@imoulife.com](mailto:service.global@imoulife.com)

Promettiamo di rispondere entro 24 ore.

Le risposte alle domande più frequenti sono disponibili all'indirizzo [imoulife.com/support/help](https://imoulife.com/support/help)

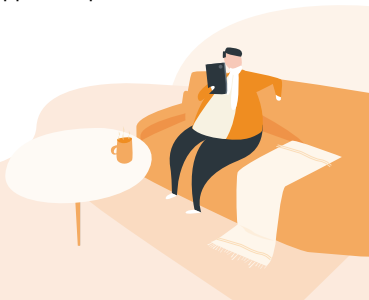

## Contenuto della confezione



Telecamera x1

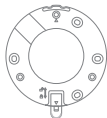

Mounting Plate x1

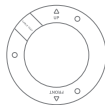

Dima di posizionamento x1

IT



Kit di vitix1



Guida introduttiva x1

## Introduzione alla telecamera

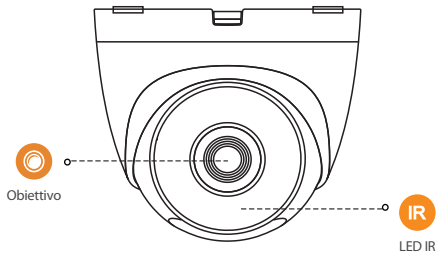

## Scene1:

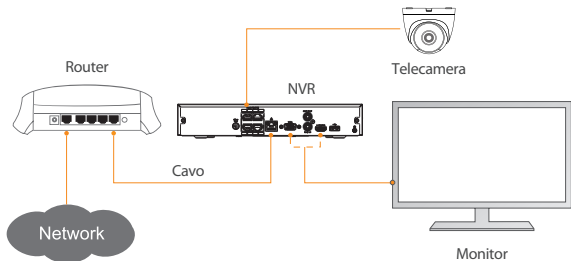

## Scene2:

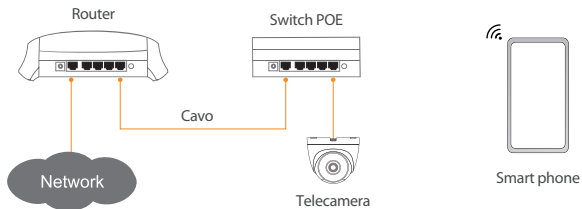



1

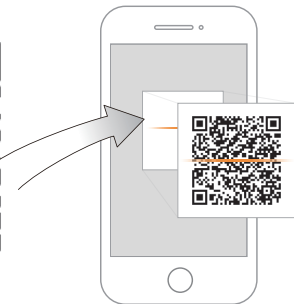

IT



Imou Life



Download on the  
App Store



GET IT ON  
Google play



Windows

2

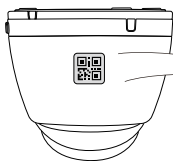

## Montaggio a soffitto

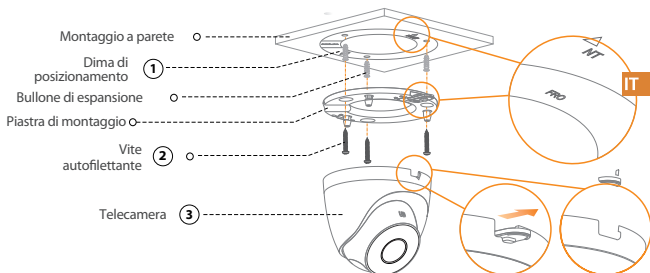

### Regolazione dell'angolazione:

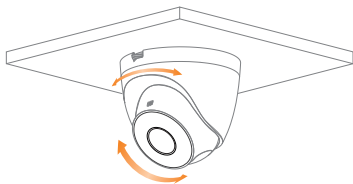

### Montaggio a parete:

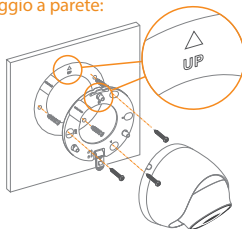

## Risoluzione dei problemi

Problema	Soluzione
La telecamera non funziona o non si avvia normalmente	<ul style="list-style-type: none"><li>• Accertarsi che il cavo di rete sia collegato in modo corretto e che l'NVR o lo switch supportino l'alimentazione POE.</li></ul>
Dove vengono salvati i video registrati	<ul style="list-style-type: none"><li>• Scene1 I video registrati vengono salvati sull'NVR.</li><li>• Scene2 I video vengono salvati sul cloud Imou se questo è attivo.</li><li>• Scene3 La luce a infrarossi si riflette sull'obiettivo e il risultato non è buono. Per evitare occlusioni intorno all'obiettivo, regolarne l'angolo.</li></ul>
L'effetto IR non è buono	<ul style="list-style-type: none"><li>• La luce a infrarossi si riflette sull'obiettivo e il risultato non è buono. Per evitare occlusioni intorno all'obiettivo, regolarne l'angolo.</li></ul>

# Snelstartgids

T22A

NL

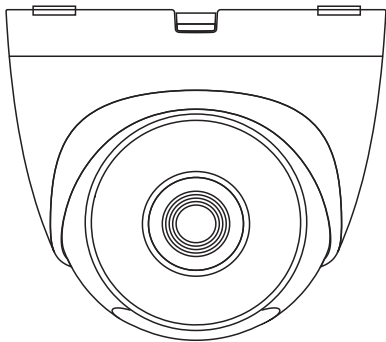

# Welkom

Bedankt dat u voor Imou heeft gekozen.

NL

Onze toewijding is om u eenvoudige Smart Home producten te bieden. Als u problemen ervaart met het gebruik van uw product, neem dan eerst contact op met onze service team: [service.global@imoulife.com](mailto:service.global@imoulife.com)

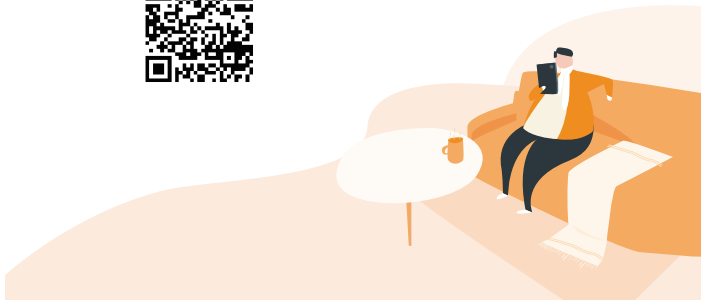

## Inhoud verpakking



Camera x1

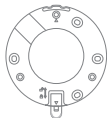

Mounting Plate x1

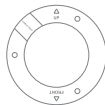

Kaart installatiepositie x1

NL



Schroevenset x1



Snel startgids x1

## Introductie camera

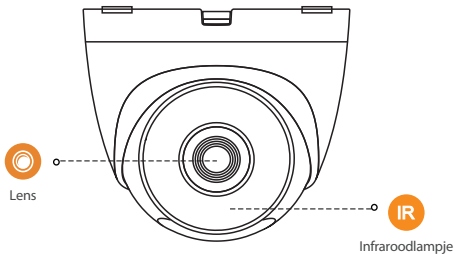

## Scène1:

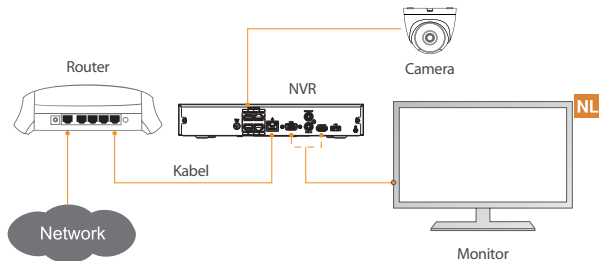

## Scène2:

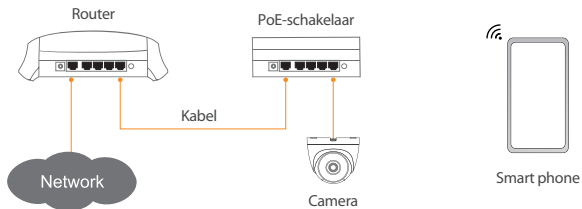

1

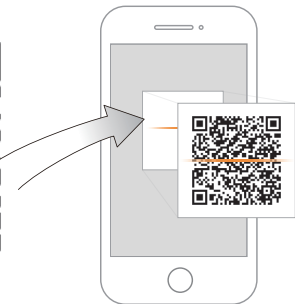

NL



2

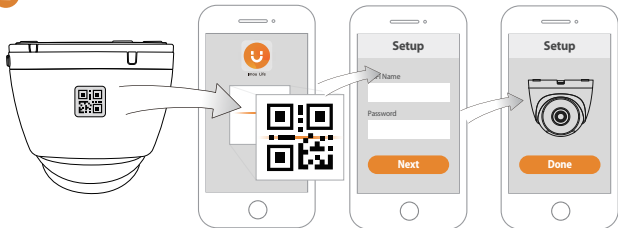



## Plafondbevestiging

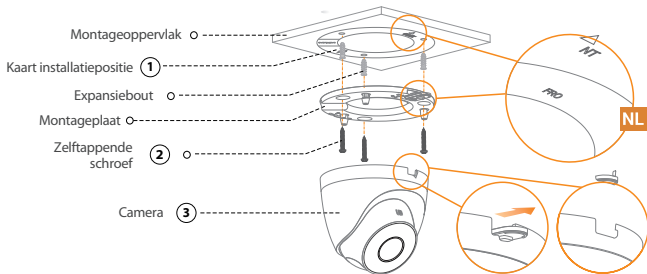

### De hoek aanpassen:

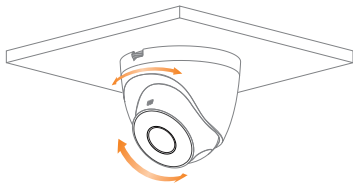

### Wandmontage:

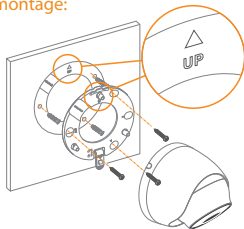

## Probleemoplossing

Probleem	Oplossing
De camera kan niet normaal functioneren of opstarten	• Zorg dat de netwerkkabel correct is aangesloten en dat de NVR of switch de POE-voeding ondersteunt.
Waar worden de opgenomen video's opgeslagen	<ul style="list-style-type: none"><li>• Scène1 Opgenomen video's worden opgeslagen in NVR.</li><li>• Scène2 Als de Imou-cloud is ingeschakeld, worden opgenomen video's opgeslagen in de Imou-cloud.</li><li>• Scène3 Het infraroodlicht wordt weerkaatst op de lens, waardoor het effect niet goed is. Pas de lenshoek aan om occlusies rond de lens te voorkomen.</li></ul>
Het infraroodeffect is niet goed	• Het infraroodlicht wordt weerkaatst op de lens, waardoor het effect niet goed is. Pas de lenshoek aan om occlusies rond de lens te voorkomen.

# Guia rápido

## T22A

PT

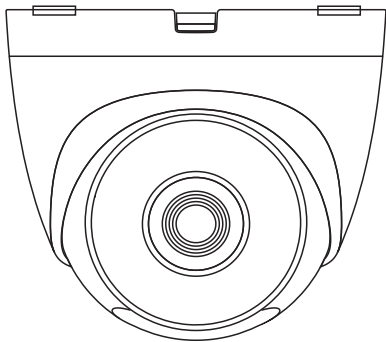

# Bem-vindo

Obrigado por escolher a IMOU.

Estamos empenhados em fornecer produtos inteligentes e simplificados para o lar. Se tiver problemas ao utilizar o produto, contacte a nossa equipa de assistência antes de devolver o produto.

PT

O nosso e-mail de assistência: [service.global@imoulife.com](mailto:service.global@imoulife.com)  
Prometemos responder no prazo de 24 horas.

Pode encontrar as Perguntas frequentes em [imoulife.com/support/help](https://imoulife.com/support/help)



## Conteúdo da embalagem



Câmarax1

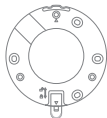

Mounting Plate x1

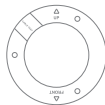

Mapa de  
posicionamento x1



Conjunto de parafusosx1



Snel startgidsx1

PT

## Apresentação da câmara

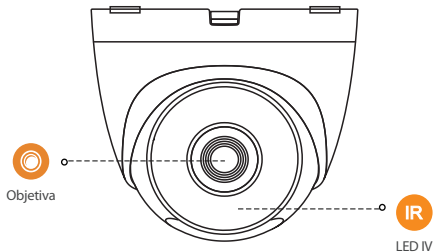

### Cena1:

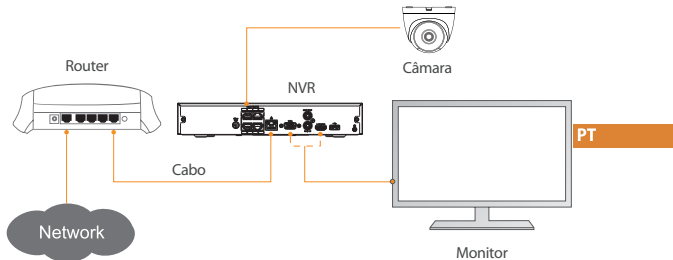

### Cena2:

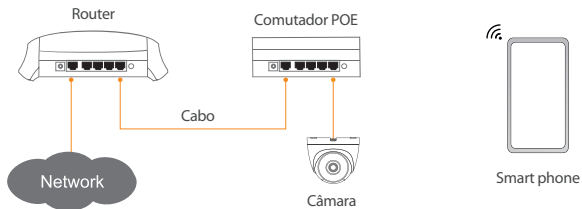

1

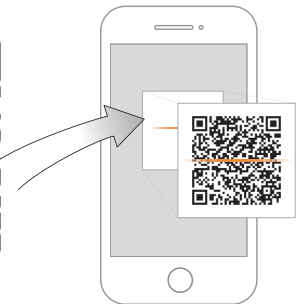

PT



Imou Life



2

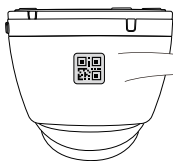

## Montagem no teto

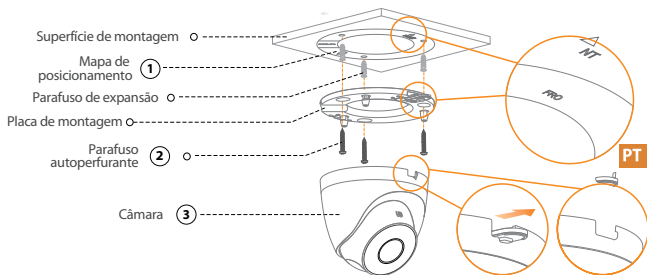

## Ajustar o ângulo:

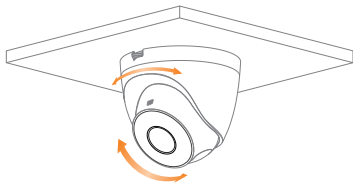

## Montagem em parede:

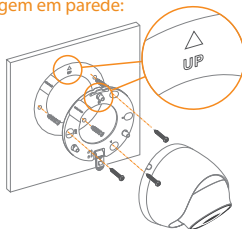



## Solução de problema

Problema	Solução
A câmara não funciona normalmente ou não inicia	<ul style="list-style-type: none"><li>• Certifique-se de que o cabo de rede está bem ligado, e se o NVR ou computador suporta a alimentação tipo POE.</li></ul>
Onde se encontram guardados os vídeos gravados	<ul style="list-style-type: none"><li>• Cena1 Os vídeos gravados estão guardados no NVR.</li><li>• Cena2 Quando a nuvem Imou está ativada, os vídeos gravados são guardados na nuvem Imou.</li><li>• Cena3 A luz infravermelha é refletida na lente, por isso o efeito não é satisfatório. Ajuste o ângulo da lente para evitar oclusões em volta da lente.</li></ul>
O efeito de IV não é satisfatório	<ul style="list-style-type: none"><li>• A luz infravermelha é refletida na lente, por isso o efeito não é satisfatório. Ajuste o ângulo da lente para evitar oclusões em volta da lente.</li></ul>

PT

# imou

Enjoy Smart Life



CE FC CCC UL  ISO 9001:2000

 @imouglobal

 service.global@imoulife.com

 www.imoulife.com