



RUT950

User manual v2.0



Wiki knowledge base
<https://wiki.teltonika.lt>







LEGAL NOTICE

Copyright © 2019 TELTONIKA Ltd. all rights reserved. Reproduction, transfer, distribution or storage of part or all of the contents in this document in any form without the prior written permission of TELTONIKA Ltd is prohibited. The manufacturer reserves the right to modify the product and manual for the purpose of technical improvement without prior notice.

Other product and company names mentioned herein may be trademarks or trade names of their respective owners.

ATTENTION

-  Before using the device we strongly recommend reading this user manual first.
-  Do not disassemble the device. Do not touch the device if the housing is broken.
-  All wireless devices for data transferring may be susceptible to interference, which could affect performance.
-  The device is not water-resistant. Keep it dry.
-  Device is powered by a low voltage 9 VDC power adapter.

SAFETY

To avoid voltage caused traumas please follow these safety requirements:

- The device is intended to be powered from a Limited Power Source (LPS) that does not exceed 15 W in power consumption and the current rating of overcurrent protective device should not exceed 2 A.
- The highest transient overvoltage in the output (secondary circuit) of used PSU shall not exceed 36 V peak.
- The device can be used with a Personal Computer (first safety class) or Notebook (second safety class). Associated equipment: PSU (power supply unit) (LPS) and personal computer (PC) shall comply with the requirements of standard EN 60950-1.
- To avoid mechanical damage to the device it is recommended to transport it packed in a damage-proof pack.

When using the device it should be placed so that its indicating LEDs would be visible as they inform in which working mode the device is in and if it has any working problems.

Protection against over current, short circuiting and earth faults should be provided as a part of the building installation.

FRONT VIEW

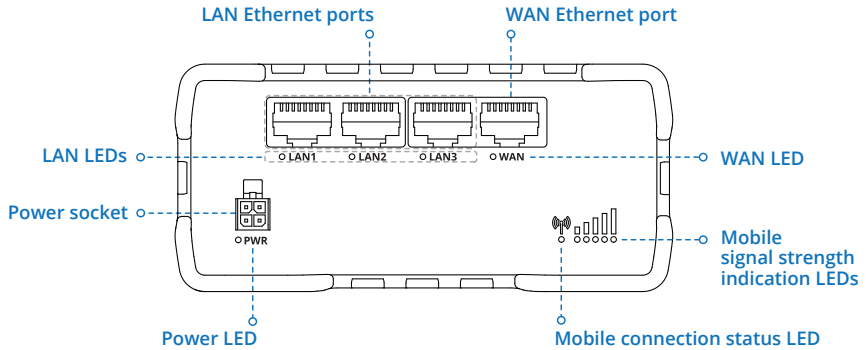

BACK VIEW

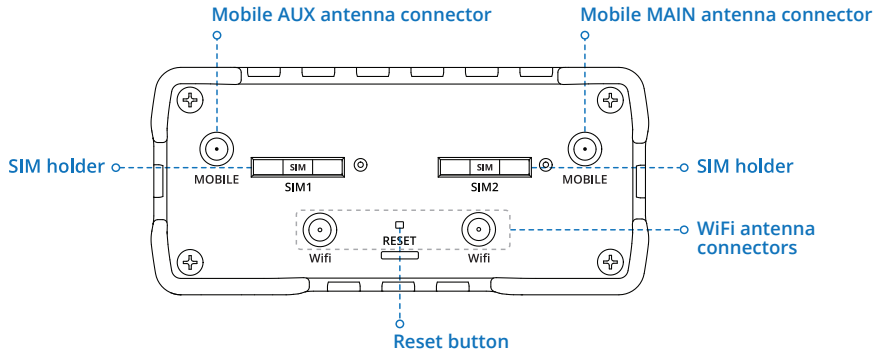

POWER SOCKET PINOUT

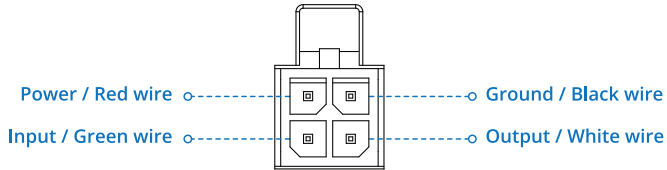

HARDWARE INSTALLATION

1. Push the SIM holder button with the SIM needle.
2. Pull out the SIM holder.
3. Insert your SIM card into the SIM holder.
4. Slide the SIM holder back into the router.
5. Attach LTE and WiFi antennas (max torque 0.9 Nm 8.0 in-lbs).
6. Connect the power adapter to the socket on the front of the device. Then plug the other end of the power adapter into a power outlet.
7. Connect to the device wirelessly (SSID: RUT950_**** (unique to each device)) or use an Ethernet cable (connected to LAN port).

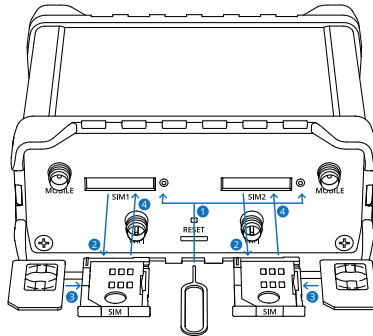

LED INDICATIONS

- Constant blinking (~ 2Hz) – router is turning on.
- LED turned off – no 4G data connection, LED turned on – 4G data connection.
- Green and red blinking alternatively ever 500 ms: no SIM or bad PIN.
- Green, red and yellow blinking alternatively every 500 ms: connecting to GSM.
- Red blinking every 1 sec: connected 2G, but no data session established.
- Yellow blinking every 1 sec: connected 3G, no data session established.
- Green blinking every 1 sec: connected 4G, no data session established.
- Red lit and blinking rapidly while data is being transferred: connected 2G with data session.
- Yellow lit and blinking rapidly while data is being transferred: connected 3G with data session.
- Green lit and blinking rapidly while data is being transferred: connected 4G with data session.

SIGNAL STRENGTH LEDS

No. of lit up LEDs	Signal strength value
0	≤ -111 dBm
1	-110 dBm to -97 dBm
2	-96 dBm to -82 dBm
3	-81 dBm to -67 dBm
4	-66 dBm to -52 dBm
5	≥ -51 dBm

LOGIN TO DEVICE

1. To enter the router's Web interface (WebUI), type <http://192.168.1.1> into the URL field of your Internet browser.
2. Use login information shown in image A when prompted for authentication.
3. After you log in, you will be prompted to change your password for security reasons. The new password must contain at least 8 characters, including at least one uppercase letter, one lowercase letter, and one digit. This step is mandatory, and you will not be able to interact with the router's WebUI before you change the password.
4. When you change the router's password, the [Configuration Wizard](#) will start. The [Configuration Wizard](#) is a tool used to set up some of the router's main operating parameters.
5. Go to the [Status > Network](#) page and pay attention to the [Signal Strength](#) indication (image B). To maximize the cellular performance try adjusting the antennas or changing the location of your device to achieve the best signal conditions.

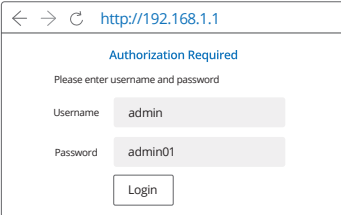
A. 

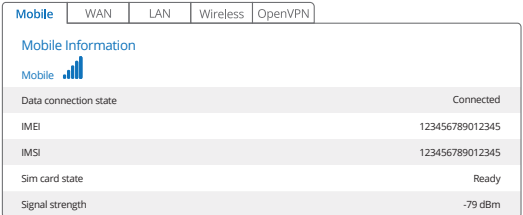
B. 

GPL

Some products of Teltonika partly contain software code developed by third parties, including software code subject to the GNU General Public License ("GPL") version 2, version 3, GNU Lesser General Public License ("LGPL") version 2.1 and other open source licenses.

In order to comply with the terms of the GPL, Teltonika, where applicable, offers a mail in service of a machine readable source code of the software subject to the GPL, on an optical media (CD-ROM) upon request by mail or email. Further information is provided with the relevant products or the software. You can download the free copies of the respective machine readable source code of the software which is subject to the GPL and contained in Teltonika products if you follow this internet link: <https://wiki.teltonika.lt/index.php?title=GPL>

The respective programs are distributed WITHOUT ANY WARRANTY; without even the implied warranty of MERCHANTABILITY or FITNESS FOR A PARTICULAR PURPOSE. See the respective GNU General Public License for more details.

Please choose the model and version of your Teltonika product from the list found in the provided link in order to download the source code. You can also review and print the respective GPL license terms.

If you have any more questions or suggestions regarding GPL, please contact us at [gpl@teltonika.lt](mailto:/gpl@teltonika.lt)

SPECIFICATIONS

HARDWARE

- High performance 550 MHz CPU with 128 MB of DDR2 memory
- 16 MB SPI Flash memory
- 4 pin industrial DC power socket
- External SIM holders, 2 x SIM slots (Mini SIM – 2FF, 2st form factor)
- Reset/restore to default button
- 2 x SMA for LTE, 2 x RP-SMA for WiFi antenna connectors
- 4 x LAN status LEDs, 1 x Power LED
- 1 x bi-color connection status LED, 5 x connection strength LEDs
- DIN rail (can be mounted on two sides), flat surface placement

ETHERNET

- IEEE 802.3, IEEE 802.3u standards
- 3 x LAN ports, 10/100 Mbps
- 1 x WAN port (can be configured to LAN) 10/100 Mbps
- Supports Auto MDI/MDIX

Wi-Fi

- IEEE 802.11b/g/n WiFi standards
- 2x2 MIMO
- Access Point (AP), Station (STA) modes
- WPA, WPA2, WPA&WPA2 encryption methods
- 2.401 – 2.483 GHz WiFi frequency range*
- 20 dBm max WiFi TX power
- SSID stealth mode and access control based on MAC address
- Up to 100 simultaneous connections
- Captive portal (Hotspot), internal/external Radius server
- Built in customizable hotspot landing page

*Supported frequency bands are dependent on geographical location and may not be available in all markets

TECHNICAL INFORMATION

Radio specifications

RF technologies	GSM, GPRS, EDGE, UMTS/HSPA+, LTE, GNSS, WiFi
Max RF power	33 dBm@GSM, 24 dBm@WCDMA, 23 dBm@LTE, 20 dBm@WiFi
Bundled antennas specifications*	
GSM/WCDMA/LTE antenna	698–960/1710–2690 MHz, 50 Ω, VSWR<3, gain** 3 dBi, omnidirectional, SMA male connector
WiFi antenna	2400–2483.5 MHz, 50 Ω, VSWR<2, gain** 5 dBi, omnidirectional, RP-SMA male connector

*Order code dependent.

**Higher gain antenna can be connected to compensate for cable attenuation when a cable is used. The user is responsible for the compliance with the legal regulations.

ELECTRICAL, MECHANICAL & ENVIRONMENTAL

Dimensions (W x D x H)	80 mm x 106 mm x 46 mm
Weight	235 g
Power supply	100 – 240 VAC -> 9 VDC wall adapter
Input voltage range	9 – 30 VDC
Power consumption	< 2W idle, < 7W Max
Operating temperature	- 40 °C to 75 °C
Storage temperature	- 45 °C to 80 °C
Operating humidity	10 % to 90 % Non-condensing
Storage humidity	5 % to 95 % Non-condensing

SAFETY INFORMATION

RUT950 router must be used in compliance with any and all applicable national and international laws and with any special restrictions regulating the utilization of the communication module in prescribed applications and environments.

[EN] English	Hereby, TELNONIKA declares that this RUT950 is in compliance with the essential requirements and other relevant provisions of Directive CE/RED.
[BG] Bulgarian	С настоящето, TELNONIKA декларира, че RUT950 е в съответствие със съществените изисквания и другите приложими разпоредби на Директива CE/RED.
[CZ] Czech	TELNONIKA tímto prohlašuje, že RUT950 splňuje základní požadavky a všechna příslušná ustanovení Směrnice CE/RED.
[DE] German	Hiermit erklärt TELNONIKA dass sich das Gerät RUT950 in Übereinstimmung mit den grundlegenden Anforderungen und den übrigen einschlägigen Bestimmungen der Richtlinie CE/RED befindet.
[DK] Danish	Undertegnede TELNONIKA erklærer herved, at følgende udstyr RUT950 overholder de væsentlige krav og øvrige relevante krav i direktiv CE/RED.
[EE] Estonian	Käesolevaga kinnitab TELNONIKA seadme RUT950 vastavust direktiivi CE/RED põhinõuetele ja nimetatud direktiivist tulenevatele teistele asjakohastele sätetele.
[ES] Spanish	Por la presente, TELNONIKA declara que este RUT950 cumple con los requisitos esenciales y otras exigencias relevantes de la Directiva CE/RED.
[FI] Finnish	TELNONIKA vakuuttaa täten että RUT950 tyyppinen laite on direktiivin CE/RED oleellisten vaatimusten ja sitä koskevien direktiivin muiden ehtojen mukainen.
[FR] French	TELNONIKA déclare que cette RUT950 est conforme aux exigences essentielles et aux autres dispositions pertinentes de la directive CE / RED.
[GR] Greek	ΜΕ ΤΗΝ ΠΑΡΟΥΣΑ Ο ΚΑΤΑΣΚΕΥΑΣΤΗΣ ΤΗΣ ΤΕΛΝΟΝΙΚΑ ΔΗΛΩΝΕΙ ΟΤΙ ΤΟ RUT950 ΣΥΜΜΟΡΦΩΝΕΤΑΙ ΠΡΟΣ ΤΙΣ ΟΥΣΙΩΔΕΙΣ ΑΠΑΙΤΗΣΕΙΣ ΚΑΙ ΤΙΣ ΛΟΙΠΕΣ ΣΧΕΤΙΚΕΣ ΔΙΑΤΑΞΕΙΣ ΤΗΣ ΟΔΗΓΙΑΣ CE/RED.
[HU] Hungarian	A TELNONIKA ezennel kijelenti, hogy a RUT950 típusú berendezés teljesíti az alapvető követelményeket és más CE/RED irányelvben meghatározott vonatkozó rendelkezéseket.
[IT] Italian	Con la presente TELNONIKA dichiara che questo RUT950 è conforme ai requisiti essenziali ed alle altre disposizioni pertinenti stabilite dalla direttiva CE/RED.
[LT] Lithuanian	Šiuo dokumentu UAB TELNONIKA deklaruoja, kad šis RUT950 atitinka esminius reikalavimus ir kitas CE/RED Direktyvos nuostatas.
[LV] Latvian	Ar šo TELNONIKA deklarē, ka RUT950 atbilst Direktīvas CE/RED būtiskajām prasībām un citiem ar to saistītajiem noteikumiem.
[NL] Dutch	Hierbij verklaart TELNONIKA dat het toestel I RUT950 in overeenstemming is met de essentiële eisen en de andere relevante bepalingen van richtlijn CE/RED.
[NO] Norwegian	TELNONIKA Erklærer herved at RUT950 er i samsvar med de grunnleggende krav og øvrige relevante krav i direktiv CE/RED.
[PL] Polish	Niniejszym TELNONIKA deklaruje że RUT950 jest zgodny z zasadniczymi wymaganiami i innymi właściwymi postanowieniami Dyrektywy CE/RED.
[PT] Portuguese	Eu, TELNONIKA declaro que o RUT950 cumpre os requisitos essenciais e outras provisões relevantes da Directiva CE/RED.
[RO] Romanian	Prin prezenta, TELNONIKA declară că aparatul RUT950 este în conformitate cu cerințele esențiale și cu alte prevederi pertinente ale Directivei CE/RED.
[SE] Swedish	Härmed intygar TELNONIKA att denna RUT950 är i överensstämmelse med de väsentliga egenskapskrav och övriga relevanta bestämmelser som framgår av direktiv CE/RED.
[SI] Slovenian	TELNONIKA izjavlja, da je ta RUT950 v skladu z bistvenimi zahtevami in drugimi relevantnimi določili direktive CE/RED.

Declaration of Conformity (DoC) can be obtained by visiting <https://wiki.telnonika.lt/>

- [EN]** Instruction Manual: Connect the power adapter to turn on the device. Open 192.168.1.1 in your web browser to configure it. More information on <https://wiki.teltonika.lt>
- [BG]** Инструкции: Свържете адаптера на захранване, за да включите устройството. Отворете 192.168.1.1 в уеб браузър, за да настроите продукта. Повече информация в <https://wiki.teltonika.lt>
- [CZ]** Návod k použití: Připojte napájecí adaptér k zapnutí přístroje. Otevřete 192.168.1.1 ve webovém prohlížeči pro konfiguraci produktu. Více informací najdete v <https://wiki.teltonika.lt>
- [DE]** Bedienungsanleitung: Verbinden Sie das Netzteil, um das Gerät einzuschalten. Öffnen Sie 192.168.1.1 in einem Web Browser, um das Produkt zu konfigurieren. Weitere Informationen im <https://wiki.teltonika.lt>
- [DK]** Instruktionsbog: Tilslut strømadapteren for at tænde for enheden. Åbn 192.168.1.1 i en webbrowser til at konfigurere produktet. Mere information i <https://wiki.teltonika.lt>
- [EE]** Kasutusjuhend: Ühendage toiteadapter seadme sisselülitamiseks. Avatud 192.168.1.1 in veebilehitseja seadistada toodet. Rohkem teavet <https://wiki.teltonika.lt>
- [ES]** Manual de instrucciones: Conecte el adaptador de alimentación para encender la unidad. Abra 192.168.1.1 en un navegador web para configurar el producto. Más información en <https://wiki.teltonika.lt>
- [FI]** Käyttöohje: Kytke virtalähde päälle laitteen. Avaa 192.168.1.1 selaimen määräättää tuotteen. Lisää tietoa <https://wiki.teltonika.lt>
- [FR]** Mode d'emploi: Connectez l'adaptateur d'alimentation pour allumer l'appareil. Ouvrez 192.168.1.1 dans un navigateur Web pour configurer le produit. Plus d'Informations dans <https://wiki.teltonika.lt>
- [GR]** εγχειρίδιο οδηγιών: Συνδέστε τον προσαρμογέα τροφοδοσίας για να ενεργοποιήσετε τη μονάδα. Ανοίξτε 192.168.1.1 σε ένα πρόγραμμα περιήγησης στο Web για να διαμορφώσετε το προϊόν. Περισσότερες πληροφορίες στο <https://wiki.teltonika.lt>
- [HU]** Használati utasítás: Csatlakoztassa a hálózati adaptert a készülék bekapcsolásához. Megnyitása 192.168.1.1 egy webböngészőben beállítani a terméket. Több információ <https://wiki.teltonika.lt>
- [IT]** Manuale di istruzioni: Collegare l'adattatore di alimentazione per accendere l'unità. Aprire 192.168.1.1 in un browser Web per configurare il prodotto. Maggiori informazioni in <https://wiki.teltonika.lt>
- [LT]** Naudojimosi instrukcija: Prijunkite maitinimo adapterį, įjunkite įrenginį. Interneto naršyklėje atidarykite adresą 192.168.1.1 - galite konfigūruoti gaminį. Daugiau informacijos rasite <https://wiki.teltonika.lt>
- [LV]** Lietošanas instrukcija: Pievienojiet Strāvas adapteri, lai ieslēgtu ierīci. Atvērt 192.168.1.1 ar interneta pārlūku, lai konfigurētu produktu. Plašāka informācija <https://wiki.teltonika.lt>
- [NL]** Handleiding: Sluit voedingsadapter aan op het apparaat in te schakelen. Open 192.168.1.1 in een webbrowser om het product te configureren. Meer informatie in <https://wiki.teltonika.lt>
- [NO]** Bruksanvisningen: Koble strømadapteren for å slå på enheten. Åpne 192.168.1.1 i en nettleser for å konfigurere produktet. Mer informasjon på <https://wiki.teltonika.lt>
- [PL]** Instrukcja obsługi: Podłącz adapter zasilania, aby włączyć urządzenie. Otwórz 192.168.1.1 w przeglądarce internetowej, aby skonfigurować urządzenie. Więcej informacji w <https://wiki.teltonika.lt>
- [PT]** Manual de instruções: Conecte o adaptador de alimentação para ligar o aparelho. Abra 192.168.1.1 em um navegador da web para configurar o produto. Mais informações em <https://wiki.teltonika.lt>
- [RO]** Instrucțiuni de utilizare: Conectați adaptorul de alimentare pentru a porni aparatul. Deschide 192.168.1.1 întrun browser web pentru a configura produsul. Mai multe informații în <https://wiki.teltonika.lt>
- [SE]** Instruktionsmanual: Anslut nätadapter tern för att slå på enheten. Öppna 192.168.1.1 i en webbläsare för att konfigurera produkten. Mer information på <https://wiki.teltonika.lt>
- [SI]** Navodila: Priključite napajalnik za vklop naprave. Odprite 192.168.1.1 v spletnem brskalniku nastaviti izdelek. Več informacij v <https://wiki.teltonika.lt>
- [SK]** NávodZn na použitie: Pripojte napájací adaptér k zapnutiu prístroja. Otvorte 192.168.1.1 vo webovom prehliadači pre konfiguráciu produktu. Viac informácií nájdete v <https://wiki.teltonika.lt>

For more information visit www.teltonika.lt



This sign on the package means that **all** used electronic and electric equipment should not be mixed with general household waste.



Hereby, Teltonika declares that the radio equipment type RUT950 is in compliance with Directives: 2014/53/EU, 2014/35/EU, 2014/30/EU. The full text of the EU declaration of conformity is available at the following internet address: <https://teltonika.lt/product/rut950/>