



Business Networking Solution

# Installation Guide

JetStream Stackable L3 Managed Switch

T3700G-28TQ/T3700G-52TQ



# About this Installation Guide

This Installation Guide describes the hardware characteristics, installation methods and the points that should be attended to during the installation. This Installation Guide is structured as follows:

## Chapter 1 Introduction

This chapter describes the external components of the switch.

## Chapter 2 Preparing for Installation

This chapter illustrates the safety precautions before installing the switch.

## Chapter 3 Installation

This chapter illustrates how to install the switch.

## Chapter 4 Connection

This chapter illustrates how to do the physical connection of the switch.

## Appendix A Troubleshooting

## Appendix B Hardware Specifications

# Audience



This Installation Guide is for:

Network Engineer

Network Administrator

# Conventions

- Some models featured in this guide may be unavailable in your country or region. For local sales information, visit <http://www.tp-link.com>.
- The figures in Chapter 2 to Chapter 4 are for demonstration purposes only. Your switch may differ in appearance from that depicted.
- This Guide uses the specific formats to highlight special messages. The following table lists the notice icons that are used throughout this guide.

	Remind to be careful. A caution indicates a potential which may result in device damage.
	Remind to take notice. The note contains the helpful information for a better use of the product.

# Related Document

The User Guide and CLI Reference Guide of the product are provided on the resource CD. To obtain the latest product information, please visit the official website:

<http://www.tp-link.com>

# Contents

---

Chapter 1	Introduction	01
1.1	Product Overview	01
1.2	Appearance	01
Chapter 2	Preparing for Installation	05
2.1	Package Contents	05
2.2	Safety Precautions	05
2.3	Installation Tools	07
2.4	Installation and Connection Flow	07
Chapter 3	Installation	09
3.1	Desktop Installation	09
3.2	Rack Installation	09
3.3	Installing and Removing the Power Supply Module	10
3.4	(Optional) Installing and Removing the Interface Card	11
3.5	Stacking Using Interface Card on Rear Panel	12
Chapter 4	Connection	14
4.1	Ethernet Port	14
4.2	SFP Port	14
4.3	Console Port	14
4.4	Verify Installation	15
4.5	Power On	16
4.6	Initialization	16
4.7	Accessing the Switch	16
Appendix A	Troubleshooting	17
Appendix B	Hardware Specifications	18

# Chapter 1 Introduction

## 1.1 Product Overview

T3700G-28TQ/T3700G-52TQ is an L3 managed switch that features advanced L3 routing, 10Gbps wire-speed, physical stacking and removable power supply module and fan module, designed to meet the needs of convergence layer. T3700G-28TQ/T3700G-52TQ is ideal for large businesses, campuses or SMB networks requiring an outstanding, reliable and affordable 10 Gigabit solution.

T3700G-28TQ/T3700G-52TQ supports stacking of up to 8 units, thus providing flexible scalability and protective redundancy for your networks. Moreover, aiming to better protect your network, T3700G-28TQ/T3700G-52TQ supports 2 power supply modules. T3700G-28TQ/T3700G-52TQ can fully implement resilient scalable networks due to its advanced features such as OSPF, VRRP, IGMP and PIM DM/SM.

## 1.2 Appearance

### Front Panel

The front panel of T3700G-28TQ is shown as the following figure.

Figure 1-1 Front Panel of T3700G-28TQ

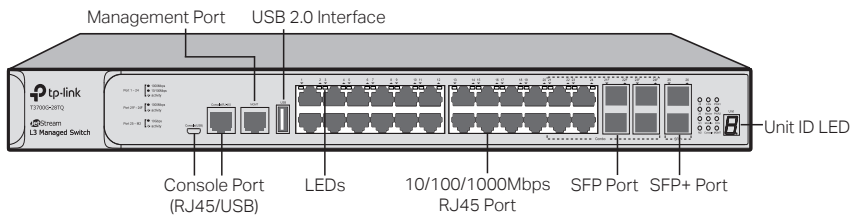

The front panel of T3700G-52TQ is shown as the following figure.

Figure 1-2 Front Panel of T3700G-52TQ

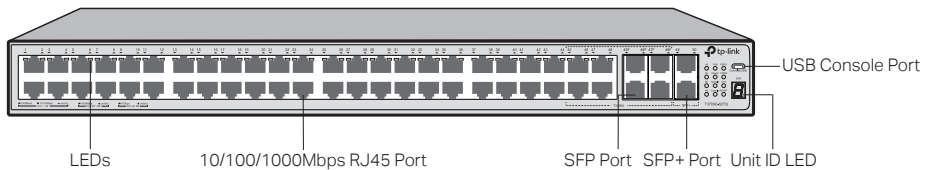

### LEDs

LED	Indication
PWR1 PWR2	<p><b>Green On:</b> The power supply module connected to the corresponding power slot works properly.</p> <p><b>Yellow On:</b> The power supply module connected to the corresponding power slot works improperly.</p> <p><b>Off:</b> The corresponding power slot is not connected to any power supply module.</p>
SYS	<p><b>Flashing:</b> The switch works properly.</p> <p><b>On or Off:</b> The switch works improperly.</p>

LED	Indication
FAN	<b>Green On:</b> The fan module works properly. <b>Yellow On:</b> The fan module works improperly. <b>Off:</b> No fan module is connected to the switch.
Master	<b>On:</b> The switch works as master in the stack system, or does not join any stack system. <b>Off:</b> The switch works as member in the stack system.
Module	<b>Green On:</b> An Interface Card is connected to the switch and works properly. <b>Yellow On:</b> An Interface Card is connected to the switch, but works improperly. <b>Off:</b> No Interface Card is connected to the switch.
Console	<b>On:</b> Data is being transmitted or received. <b>Off:</b> No data being transmitted or received for more than 6 minutes.
For T3700G-28TQ: Link/Act (Port 1-24, MGMT)  For T3700G-52TQ: Link/Act (Port 1-48, MGMT)	<b>Green On:</b> Running at 1000Mbps, but no activity. <b>Green Flashing:</b> Running at 1000Mbps and is transmitting or receiving data. <b>Yellow On:</b> Running at 10/100Mbps, but no activity. <b>Yellow Flashing:</b> Running at 10/100Mbps and is transmitting or receiving data. <b>Off:</b> No device is linked to the corresponding port.
For T3700G-28TQ: 25, 26  For T3700G-52TQ: 49, 50	<b>On:</b> An SFP+ transceiver/cable is connected to the corresponding port, and it is connected to a 10Gbps device, but no activity. <b>Flashing:</b> A 10Gbps device is connected to the corresponding port and transmitting data. <b>Off:</b> An SFP+ transceiver/cable is connected to the corresponding port, but it is not connected to a device, or no SFP+ transceiver/cable is connected.
M1, M2	<b>On:</b> An SFP+ transceiver/cable is connected to the corresponding port of the Interface Card, and it is connected to a 10Gbps device, but no activity. <b>Flashing:</b> A 10Gbps device is connected to the corresponding port of the Interface Card and transmitting data. <b>Off:</b> No Interface Card is connected, or no SFP+ transceiver/cable is connected to the installed Interface Card, or an SFP+ transceiver/cable is connected to the corresponding port of the Interface Card, but it is not connected to a device.

■ **Rear Panel**

The rear panel of T3700G-28TQ is shown as the following figure.

Figure 1-3 Rear Panel of T3700G-28TQ (1)

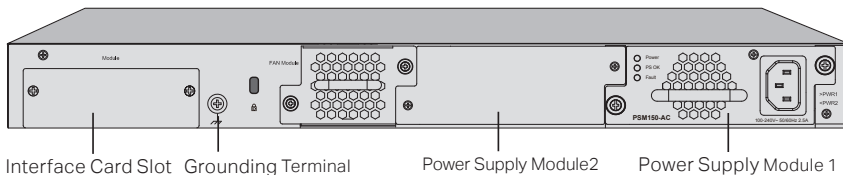

The rear panel of T3700G-52TQ is shown as the following figure.

Figure 1-4 Rear Panel T3700G-52TQ (1)

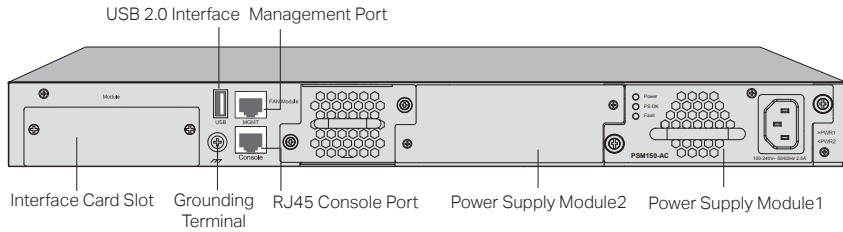

**Note:**

The Interface Card Slot and Power Supply Module2 are shipped with protective covers.

### 10/100/1000Mbps Port

Designed to connect to the device with a bandwidth of 10Mbps, 100Mbps or 1000Mbps. Each has a corresponding Link/Act LED.

### SFP Port

Designed to install the SFP transceiver. These four SFP transceiver slots are shared with the associated RJ45 ports. The associated two ports are referred as a “Combo” port, which means they cannot be used simultaneously, otherwise only RJ45 port works. The SFP ports support 1000M SFP module connection only.

### SFP+ Port

Designed to install the 10Gbps SFP+ transceiver or SFP+ cables. T3700G-28TQ/T3700G-52TQ also provides an interface card slot on the rear panel to install the expansion card (TX432 of TP-Link for example). If TX432 is installed, you get another two 10Gbps SFP+ ports.

### Console Port (USB/RJ45)

Designed to connect with the USB port of a computer for monitoring and configuring the switch. The switch has an RJ45 console port and a micro-USB console port available. Console input is active on only one console port at a time. By default, the micro-USB connector takes precedence over the RJ45 connector.

### USB 2.0 Interface

USB 2.0 interface is used to connect peripheral equipment.

### Management Port

Designed to connect the device with a bandwidth of 10Mbps, 100Mbps or 1000Mbps. It has a corresponding MGMT LED on the front panel. You need assign an IP address for the port to manage the switch.

### Unit ID LED

Designed to display the stack Unit ID of the switch. For the switch that does not join any stack system, it displays its default Unit ID. To modify the default unit number, please logon to the GUI of the switch and go to Stack→Stack Management→Switch Renumber page.

### Interface Card Slot

Designed to extend the interfaces. You can select a TP-Link Interface Card (TX432 for example) for your switch if needed. For how to install an Interface Card, please refer to **3.4 Installing and Removing the Interface Card**.

### Grounding Terminal

The switch already comes with lightning protection mechanism. You can also ground the switch through the PE (Protecting Earth) cable of AC cord or with Ground Cable. For detailed information, please refer to the Lightning Protection Guide from the training center of our website <http://www.tp-link.com/en/configuration-guides.html>.

### Power Supply Module

The AC Power Supply Module PSM150-AC is installed in the switch. The malfunctioned PSM150-AC can be replaced with a TP-Link power supply module of the same model. Its input voltage is 100-240V~50/60Hz.

The AC Power Supply Module is fully hot swappable, helping to ensure no system interruption during installation or replacement. For how to install or remove the Power Supply Module, please refer to **3.3 Installing and Removing the Power Supply Module**.



**Caution:**

Please use the provided power cord.

### Port Feature

Model	10/100/1000Mbps RJ45 Port	RJ45 Console Port	USB Console Port	Management Port	1000Mbps SFP Port	10Gbps SFP+ Port
T3700G-28TQ	24	1	1	1	4 (Combo)	4 (2 fixed + 2 optional)
T3700G-52TQ	48	1	1	1	4 (Combo)	4 (2 fixed + 2 optional)

With all the protective covers removed and the Interface Card (TX432 for example) inserted, the rear panel of T3700G-28TQ/T3700G-52TQ is shown as the following figure.

Figure 1-5 Rear Panel of T3700G-28TQ (2)

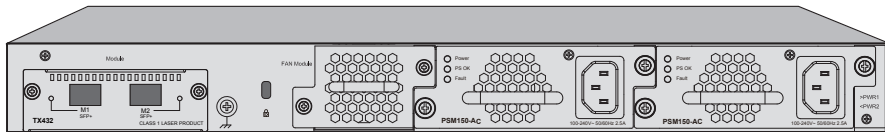
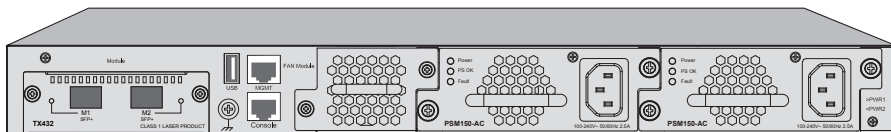

Figure 1-6 Rear Panel of T3700G-52TQ (2)





## Chapter 2 Preparing for Installation

### 2.1 Package Contents

Make sure that the package contains the following items. If any of the listed items is damaged or missing, please contact your distributor.

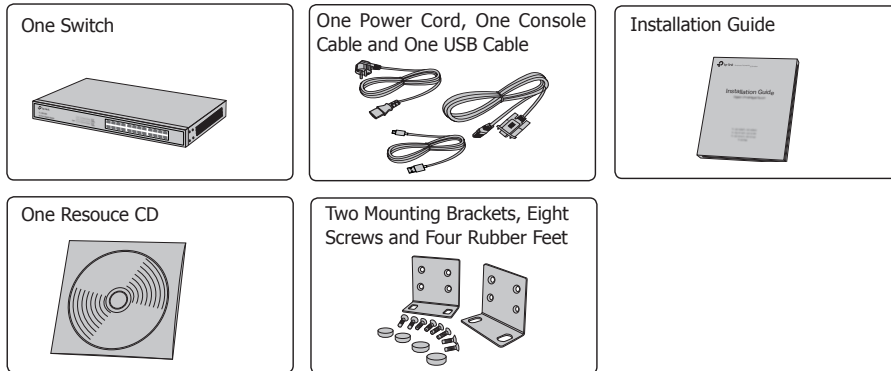

### 2.2 Safety Precautions

To avoid any device damage and bodily injury caused by improper use, please observe the following rules.

- **Safety Precautions**
  - Keep the power off during the installation.
  - Wear an ESD-preventive wrist strap, and make sure that the wrist strap has a good skin contact and is well grounded.
  - Use only the power cord provided with the switch.
  - Make sure that the supply voltage matches the specifications indicated on the rear panel of the switch.
  - Ensure the vent hole is well ventilated and unblocked.
  - Do not open or remove the cover of the switch.
  - Before cleaning the device, cut off the power supply. Do not clean it by the waterish cloth, and never use any other liquid cleaning method.
  - Place the device with its bottom surface downward.

#### Site Requirements

##### Temperature/Humidity



Please keep a proper temperature and humidity in the equipment room. Too high/low humidity may lead to bad insulation, electricity leakage, mechanical property changes and corrosions. Too high temperature may accelerate aging of the insulation materials and can thus significantly shorten the service life of the device. For normal temperature and humidity of the device, please check the following table.

Environment	Temperature	Humidity
Operating	0°C to 40°C	10% to 90%RH Non-condensing
Storage	-40°C to 70°C	5% to 90%RH Non-condensing

### Clearness



The dust accumulated on the switch can be absorbed by static electricity and result in poor contact of metal contact points. Some measures have been taken for the device to prevent static electricity, but too strong static electricity can cause deadly damage to the electronic elements on the internal circuit board. To avoid the effect of static electricity on the operation of the Switch, please attach much importance to the following items:

- Dust the device regularly, and keep the indoor air clean.
- Keep the device well grounded and ensure static electricity has been transferred.

### Electromagnetic Interference

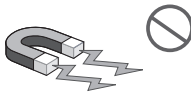

Electronic elements including capacitance and inductance on the device can be affected by external interferences, such as conducted emission by capacitance coupling, inductance coupling, and impedance coupling. To decrease the interferences, please make sure to take the following measures:

- Use the power supply that can effectively filter interference from the power grid.
- Keep the device far from high-frequency, strong-current devices, such as radio transmitting station.
- Use electromagnetic shielding when necessary.

### Lightning Protection



Extremely high voltage currents can be produced instantly when lightning occurs and the air in the electric discharge path can be instantly heated up to 20,000°C. As this instant current is strong

enough to damage electronic devices, more effective lightning protection measures should be taken.

- Ensure the rack and device are well earthed.
- Make sure the power socket has a good contact with the ground.
- Keep a reasonable cabling system and avoid induced lightning.
- Use the signal SPD (Surge Protective Device) when wiring outdoor.



**Note:** For detailed lightning protection measures, please refer to the Lightning Protection Guide from the training center of our website <http://www.tp-link.com/en/configuration-guides.html>.

### Installation Site

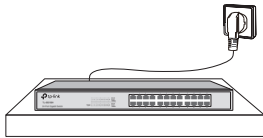

When installing the device on a rack or a flat workbench, please note the following items:

- The rack or workbench is flat and stable, and sturdy enough to support the weight of 5.5kg at least.
- The rack or workbench has a good ventilation system. The equipment room is well ventilated.
- The rack is well grounded. Keep the power socket less than 1.5 meters away from the device.

## 2.3 Installation Tools

- Phillips screwdriver
- ESD-preventive wrist wrap
- Cables



**Note:** These tools are not provided with our product. If needed, please self purchase them.

## 2.4 Installation and Connection Flow

The switch provides two interfaces to install the swappable Power Supply Module, and one interface to install the Interface Card. The switch has already been installed with a Power Supply Module PSM150-AC, and you can also self-purchase the Interface Card/Power Supply Module if needed.

## JetStream L3 Stackable Managed Switch

The Installation and Connection flow is shown as the following figure.

Figure 2-1 Installation and Connection Flow

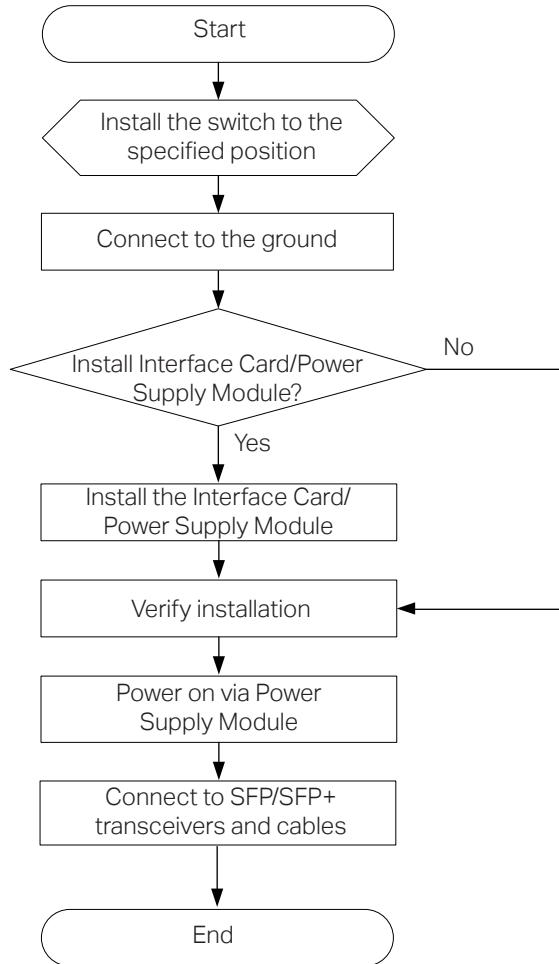

**Note:** The switch can be powered by the two Power Supply Modules simultaneously or individually. If simultaneously, the two Power Supply Modules together will enable your network to enjoy the benefit of uninterrupted operation.

## Chapter 3 Installation

### 3.1 Desktop Installation

To install the device on the desktop, please follow the steps:

1. Set the device on a flat surface strong enough to support the entire weight of the device with all fittings.
2. Remove the adhesive backing papers from the rubber feet.
3. Turnover the device and attach the supplied rubber feet to the recessed areas on the bottom at each corner of the device.

Figure 3-1 Desktop Installation

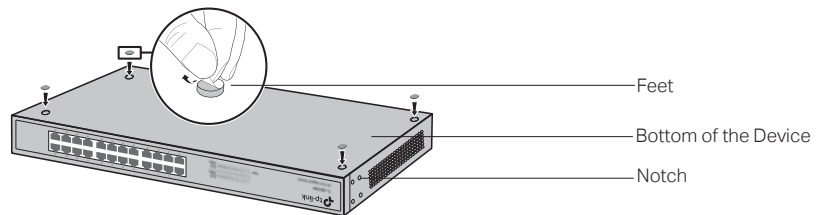

### 3.2 Rack Installation

To install the device in an EIA standard-sized, 19-inch rack, follow the instructions described below:

1. Check the grounding and stability of the rack.
2. Secure the supplied rack-mounting brackets to each side of the device with supplied screws, as illustrated in the following figure.

Figure 3-2 Bracket Installation

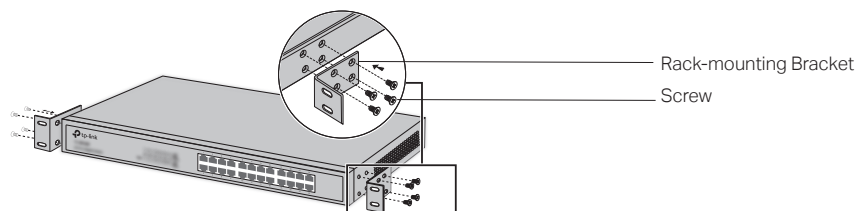

3. After the brackets are attached to the device, use suitable screws (not provided) to secure the brackets to the rack, as illustrated in the following figure.

Figure 3-3 Rack Installation

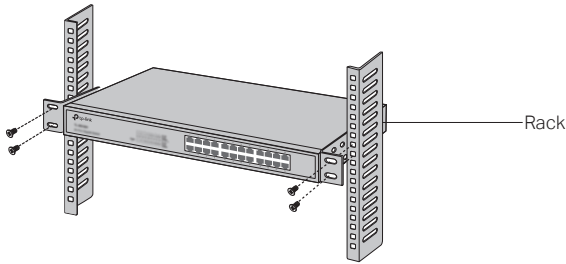

### Caution:

- Please set 5 to 10cm gaps around the device for air circulation.
- Please avoid any heavy thing placed on the device.
- Please mount devices in sequence from the bottom to top of the rack and ensure a certain clearance between devices for the purpose of heat dissipation.

## 3.3 Installing and Removing the Power Supply Module

One Power Supply Module has already been installed in the switch. Operate as the following steps if you need to replace the Power Supply Module.

### ■ Removing the Power Supply Module

1. Wear an ESD-preventive wrist strap, and make sure that it has good skin contact and is well grounded.
2. Remove the power cord from the power module and the external power supply system.
3. Use a Phillips screwdriver to loosen the captive screws at both sides of the power supply module until all spring pressure is released.
4. Pull the handle by one hand towards you along the guide rails, and hold the bottom of the module by the other hand, until it completely comes out of the switch chassis.
5. In order to better protect the removed power supply module, it is recommended to package it by an antistatic bag.
6. After removing the PSM150-AC, please install the protective cover as soon as possible to prevent dust from entering and ensure the normal ventilation in the switch.

### ■ Installing the Power Supply Module

1. Wear an ESD-preventive wrist strap, and make sure that it has good skin contact and is well grounded.
2. If the protective cover has been installed on the power supply module slot of the switch, use a Phillips screwdriver to loosen the mounting screws of the protective cover and remove the protective cover, as shown in the following figure.

Figure 3-4 Removing the Protective Cover

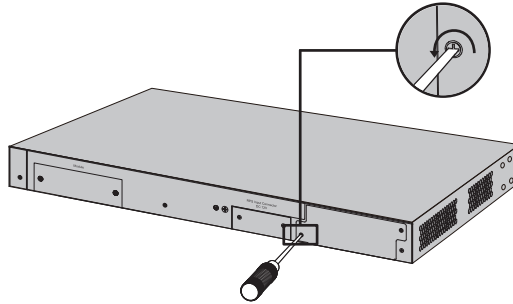

3. Grip the handle of the module by one hand, and hold the bottom of the module by the other hand, as shown in the following figure. Then gently push the module in along the slot guide rail until the module is flush with the switch.



**Note:** Do not use too much force in the operation. If resistance is encountered or positions of the power supply module appear larger deflection in the operation of installation, you must first remove the module and then reinstall the module.

Figure 3-5 Installing the Power Supply Module

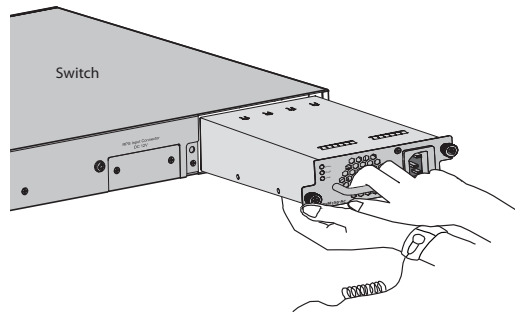

4. Tighten the captive screws with a Phillips screwdriver to fix the power supply module in place. If the screws cannot be tightened, probably because the power supply module is not installed properly. Please check carefully.

### 3.4 (Optional) Installing and Removing the Interface Card

#### ■ Installing the Interface Card

1. Wear an ESD-preventive wrist strap, and make sure that it has good skin contact and is well grounded.
2. Use a Phillips screwdriver to loosen the mounting screws of the protective cover on the interface card slot of the switch and remove the protective cover, similar to the procedure shown in Figure 3-4.

3. Hold the captive screws on the front panel of the interface card, and gently push the interface card in along the slot guide rail until the interface card is flush with the switch, as shown in the following figure.

Figure 3-6 Installing the Interface Card

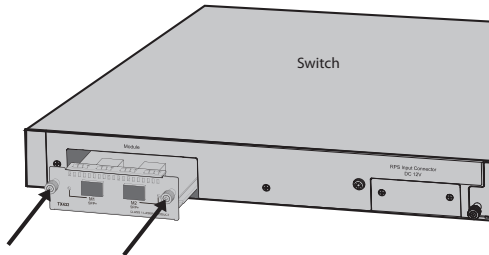

4. Tighten the captive screws with a Phillips screwdriver to fix the interface card in place.

### ▪ Removing the Interface Card

1. Wear an ESD-preventive wrist strap, and make sure that it has good skin contact and is well grounded.
2. Use a Phillips screwdriver to loosen the captive screws at both sides of the interface card until all spring pressure is released.
3. Pull the interface card towards you along the guide rails, until it completely comes out of the switch chassis.
4. After removing an interface card, if no new interface card is to be installed, please install the protective cover as soon as possible to prevent dust from entering and ensure the normal ventilation in the switch.



#### Note:

- TX432 supports hot plug, so if necessary you can install or remove the interface card when the switch is operating. However, it is recommended that the power be turned off during installation.
- Do not touch the surface-mounted components directly with your hand while the switch is in operation.

## 3.5 Stacking Using Interface Card on Rear Panel

You can connect up to 8 switches to form a stack with a single management IP address. Follow the steps below to connect the switches and configure the stack ports, then the switches will automatically elect a master unit and establish a stack. Once the stack is established, you can use any port of any switch in the stack to manage the stack system.

You can use either the SFP+ ports on the front panel or the Interface Card on the rear panel to create a stack. These two pairs of stack ports cannot be mixedly used in the stack connection.

Here we take stacking using Interface Card for example.



1. Install an Interface Card (TX432 for example) into the Interface Card Slot of each switch, see **3.4 Installing and Removing the Interface Card**.
2. Log in to the GUI of each switch, go to **Stack→Stack Management→Stack Config** page to enable the stack mode of port M1 and M2 (port 1/1/1 and 1/1/2 on the GUI). Remember to click **Save Config** after the configuration.
3. Power off the switches, and then connect a 10G SFP+ cable (TXC432-CU1M/TXC432-CU3M of TP-Link for example) between each pair of Interface Cards among the switches, thus forming a ring topology as the following figure shows. A ring topology system provides redundancy and resiliency to the stack.

Figure 3-7 Stacking Using Interface Card

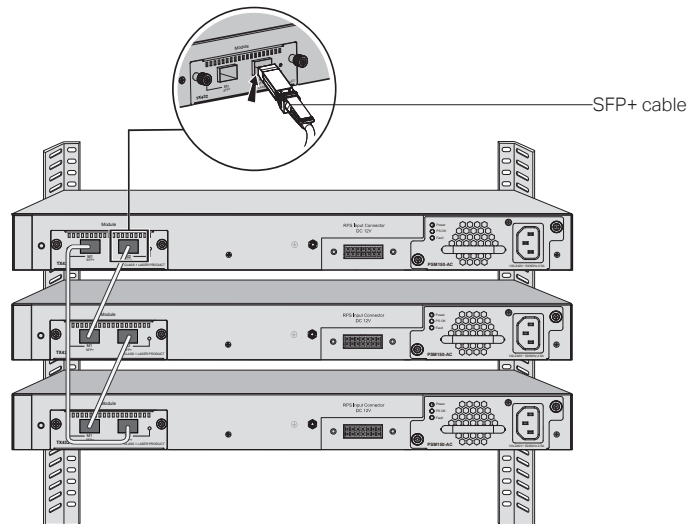

4. Power on the switches, then the switches will automatically select a master unit. The Master LED of the selected switch will be on.
5. You can access to any member of the stack via Web/SSH/Telnet/Console connection, thus to manage all the switches in the stack.

**Caution:**

- The SFP+ ports are stackable only when working in 10Gbps.
- In the process of using TP-Link SFP+ Cables, please never bend them into a radius of 45mm (1.77 inch) or less, because it may permanently damage the SFP+ Cables.

## Chapter 4 Connection

---

### 4.1 Ethernet Port

---

Connect an Ethernet port of the switch to the computer by RJ45 cable as the following figure shows.

Figure 4-1 Connecting the RJ45 Port

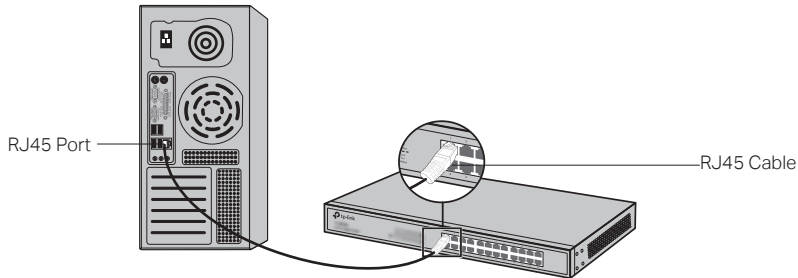

### 4.2 SFP Port

---

The following figure demonstrates the connection of SFP port to an SFP module.

Figure 4-2 Inserting the SFP Module

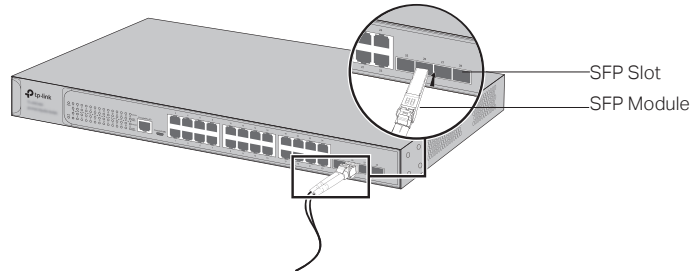

### 4.3 Console Port

---

CLI (Command Line Interface) enables you to manage the switch, thus you can load the CLI after connecting the PCs or Terminals to the console port on the switch via the provided cable.

Connect the Console (RJ45) port of the device with your computer by the console cable as the following figure shows.

Figure 4-3 Connecting the Console (RJ45) Port

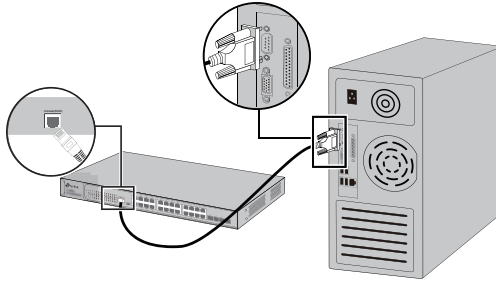

Connect the Console (USB) port of the device with your computer by the USB cable as the following figure shows.

Figure 4-4 Connecting the Console (USB) Port

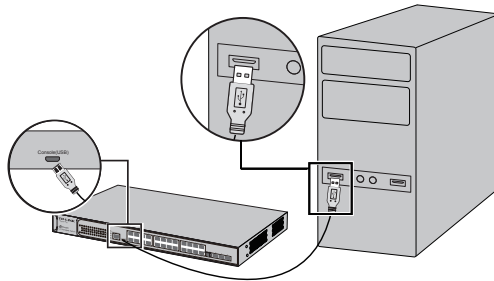

**Note:**

- Console (RJ45) port and Console (USB) port cannot be used cocurrently. Console (USB) port takes priority over the Console (RJ45) port.
- The Console (USB) port is hot-pluggable while the Console (RJ45) port is not. Please keep the device power off when plugging the console cable into the Console (RJ45) port.
- Do not connect the console port with other ports by RJ45 cable.

## 4.4 Verify Installation

After completing the installation, please verify the following items:

- There are 5 to 10cm of clearance around the sides of the device for ventilation and the air flow is adequate.
- The voltage of the power supply meets the requirement of the input voltage of the device.
- The power socket, device and rack are well grounded.
- The device is correctly connected to other network devices.

## 4.5 Power On

Plug in the negative connector of the provided power cord into the power socket of the device, and the positive connector into a power outlet as the following figure shows.

Figure 4-5 Connecting to Power Supply

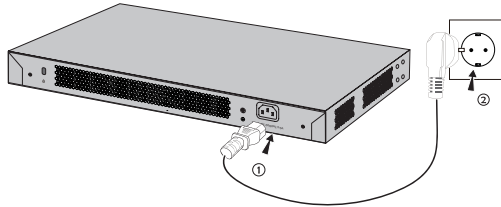

### Note:

The figure is to illustrate the application and principle. The power plug you get from the package and the socket in your situation will comply with the regulation in your country, so they may differ from the figure above.

## 4.6 Initialization

After the device is powered on, it begins the Power-On Self-Test. A series of tests run automatically to ensure the device functions properly. During this time, its LED indicators will respond as follows:

1. The PWR1 and PWR2 LEDs will enter normal work state immediately.
2. After keeping off for about one minute, the seven-segment digital tubes (Unit ID LED) will flash twice in a clockwise direction, then flash momentarily together and turn off. It will display the Unit ID after the initialization.
3. After keeping off for about one minute, the other LED indicators will flash momentarily and then turn off. They will enter normal work state after the initialization.

## 4.7 Accessing the Switch

After the initialization finished, you can access and manage the switch using the GUI (Graphical User Interface) or using the CLI (Command Line Interface).

- To access the switch using the GUI, open a web browser and type the default management address `http://192.168.0.1` in the address field, then press the Enter key. The default Username and Password are both **admin** in lower case letters.
- To access the switch using the CLI, you can use the Console port, Telnet and SSH connection. When using the Console port, start the terminal emulation program (such as the Hyper Terminal) on the PC and configure the terminal emulation program as follows:

Baud Rate	Data Bits	Parity	Stop Bits	Flow Control
38400bps	8	None	1	None

For the detailed configurations, please refer to the Configuration Guide and CLI Reference Guide. The two guides can both be found on the resource CD or on the download center of our official website: <http://www.tp-link.com/en/download-center.html>.

# Appendix A Troubleshooting

---

## Q1. What could I do if I forgot the username and password of the switch?

1. Connect the console port of the PC to the console port of the switch and open a terminal emulation program.
2. Power off and restart the switch. Perform the action indicated by the terminal emulation program to reach the bootUtil menu. The action differs from product to product. Possible actions are listed below:
  - Press any key to stop autoboot.
  - Press CTRL-B to reach the bootUtil menu.
3. The bootUtil menu will be shown. Enter the number 6 to select the "Password recovery" option and enter Y to delete all the users and passwords. The default login username and password are both admin. The other configurations in the switch will not be changed.
4. For models without the password recover feature, please select the "Reset" option to restore all the configurations to factory defaults. The default login username and password are both admin.

## Q2. Why does the PWR/Power LED work abnormally?

The PWR/Power LED should be lit up when the power system works normally. If the PWR/Power LED worked abnormally, please take the following steps:

1. Make sure that the power cable is connected properly, and the power contact is normal.
2. Make sure the voltage of the power supply meets the requirement of the input voltage of the switch.

## Q3. What should I do if I cannot access the web management page?

Please try the following:

1. Check every port LED on the switch and make sure the Ethernet cable is connected properly.
2. Try another port on the switch and make sure the Ethernet cable is suitable and works normally.
3. Power off the switch and, after a while, power it on again.
4. Make sure the IP address of your PC is set within the subnet of the switch.
5. If you still cannot access the configuration page, please restore the switch to its factory defaults. Then the IP address of your PC should be set as 192.168.0.x ("x" is any number from 2 to 254) and Subnet Mask as 255.255.255.0.

## Q4. Why is the terminal emulation program not displaying correctly?

Please try the following:

1. Make sure the power supply is normal and the console cable is properly connected.
2. Check if the console cable is the right type.
3. Ensure the parameters of the terminal emulation program are correct: configure Bits per second as 38400, Data bits as 8, Parity as None, Stop bits as 1, and Flow control as None.

## Appendix B Hardware Specifications

Item	Content
Standards	IEEE 802.3, IEEE 802.3i, IEEE 802.3u, IEEE 802.3ab, IEEE 802.3ae, IEEE 802.3ad, IEEE 802.3z, IEEE 802.3x, IEEE 802.1p, IEEE 802.1q, IEEE 802.1x, IEEE 802.1d, IEEE 802.1s, IEEE 802.1w
Transmission Medium	10Base-T: UTP/STP of Cat. 3 or above ( $\leq 100\text{m}$ )
	100Base-TX: UTP/STP of Cat. 5 or above ( $\leq 100\text{m}$ )
	1000Base-T: 4-pair UTP of Cat. 5e and Cat. 6 or above ( $\leq 100\text{m}$ )
	1000Base-X: MMF or SMF SFP Transceiver
	10GBASE-SR: MMF SFP+ Transceiver
LEDs	10GBASE-LR: SMF SFP+ Transceiver
	For T3700G-28TQ: PWR1, PWR2, SYS, MGMT, FAN, Master, Module, Console, Port 1-24, 21F-24F, 25, 26, M1, M2, Unit ID LED For T3700G-52TQ: PWR1, PWR2, SYS, MGMT, FAN, Master, Module, Console, Port 1-48, 45F-48F, 49, 50, M1, M2, Unit ID LED
Operating Temperature	0°C to 40°C (32°F to 104°F)
Storage Temperature	-40°C to 70°C (-40°F to 158°F)
Operating Humidity	10% to 90%RH Non-condensing
Storage Humidity	5% to 90%RH Non-condensing

## **FCC STATEMENT**

Product Name: JetStream L3 Stackable Managed Switch

Model Number: T3700G-28TQ/T3700G-52TQ

Responsible party:

TP-Link USA Corporation, d/b/a TP-Link North America, Inc.

Address: 145 South State College Blvd. Suite 400, Brea, CA 92821

Website: <http://www.tp-link.com/us/>

Tel: +1 626 333 0234

Fax: +1 909 527 6803

E-mail: [sales.usa@tp-link.com](mailto:sales.usa@tp-link.com)

This equipment has been tested and found to comply with the limits for a Class A digital device, pursuant to part 15 of the FCC Rules. These limits are designed to provide reasonable protection against harmful interference when the equipment is operated in a commercial environment. This equipment generates, uses, and can radiate radio frequency energy and, if not installed and used in accordance with the instruction manual, may cause harmful interference to radio communications. Operation of this equipment in a residential area is likely to cause harmful interference in which case the user will be required to correct the interference at his own expense.

This device complies with part 15 of the FCC Rules. Operation is subject to the following two conditions:

- 1) This device may not cause harmful interference.
- 2) This device must accept any interference received, including interference that may cause undesired operation.

Any changes or modifications not expressly approved by the party responsible for compliance could void the user's authority to operate the equipment.

## **CE Mark Warning**



This is a class A product. In a domestic environment, this product may cause radio interference, in which case the user may be required to take adequate measures.

## **EU declaration of conformity**

TP-Link hereby declares that the device is in compliance with the essential requirements and other relevant provisions of directives 2014/30/EU, 2014/35/EU, 2009/125/EC and 2011/65/EU.

The original EU declaration of conformity may be found at <http://www.tp-link.com/en/ce>





Продукт сертифіковано згідно с правилами системи УкрСЕПРО на відповідність вимогам нормативних документів та вимогам, що передбачені чинними законодавчими актами України.

## Safety Information

- Keep the device away from water, fire, humidity or hot environments.
- Do not attempt to disassemble, repair, or modify the device.
- Do not use damaged charger or USB cable to charge the device.
- Do not use any other chargers than those recommended.

Please read and follow the above safety information when operating the device. We cannot guarantee that no accidents or damage will occur due to improper use of the device. Please use this product with care and operate at your own risk.

この装置は、クラスA情報技術装置です。この装置を家庭環境で使用すると電波妨害を引き起こすことがあります。この場合には使用者が適切な対策を講ずるよう要求されることがあります。 VCCI-A

## BSMI Notice

### 安全諮詢及注意事項

- 請使用原裝電源供應器或只能按照本產品注明的電源類型使用本產品。
- 清潔本產品之前請先拔掉電源線。請勿使用液體、噴霧清潔劑或濕布進行清潔。
- 注意防潮，請勿將水或其他液體潑灑到本產品上。
- 插槽與開口供通風使用，以確保本產品的操作可靠並防止過熱，請勿堵塞或覆蓋開口。
- 請勿將本產品置放於靠近熱源的地方。除非有正常的通風，否則不可放在密閉位置中。
- 請不要私自打開機殼，不要嘗試自行維修本產品，請由授權的專業人士進行此項工作。

此為甲類資訊技術設備，于居住環境中使用時，可能會造成射頻擾動，在此種情況下，使用者會被要求採取某些適當的對策。

### 限用物質含有情況標示聲明書

產品元件名稱	限用物質及其化學符號					
	鉛 Pb	鎘 Cd	汞 Hg	六價鉻 CrVI	多溴聯苯 PBB	多溴二苯醚 PBDE
PCB	○	○	○	○	○	○
外殼	○	○	○	○	○	○
電源供應板	-	○	○	○	○	○





備考1. "○"系指該項限用物質之百分比含量未超出百分比含量基準值。  
備考2. "-"系指該項限用物質為排除項目。

## Industry Canada Statement

CAN ICES-3 (A)/NMB-3(A)



## Explanation of the symbols on the product label

Symbol	Explanation
	AC voltage
	Indoor use only
 	<p>RECYCLING</p> <p>This product bears the selective sorting symbol for Waste electrical and electronic equipment (WEEE). This means that this product must be handled pursuant to European directive 2012/19/EU in order to be recycled or dismantled to minimize its impact on the environment.</p> <p>User has the choice to give his product to a competent recycling organization or to the retailer when he buys a new electrical or electronic equipment.</p>







For technical support, User Guide and other information, please visit  
<http://www.tp-link.com/support>, or simply scan the QR code