



User Guide

AV1300 Gigabit Pass-through Powerline ac Wi-Fi Extender
TL-WPA8631P/TL-WPA8635P

Contents

| | |
|---|-----------|
| About This Guide | 1 |
| Chapter 1. Get to Know Your Powerline Extender | 3 |
| 1.1. Product Overview..... | 4 |
| 1.2. Product Appearance..... | 4 |
| 1.2.1. LED Legend | 4 |
| 1.2.2. Physical Interface | 5 |
| Chapter 2. Initial Use | 7 |
| 2.1. To Set Up a New Secure Wireless Network | 8 |
| 2.2. To Extend the Existing Wireless Network..... | 11 |
| Chapter 3. Configuring via Web Management Interface..... | 13 |
| 3.1. Management Interface..... | 14 |
| 3.1.1. Log In | 14 |
| 3.1.2. Change the Login Account | 15 |
| 3.2. Manage Powerline Network..... | 15 |
| 3.2.1. Add a New Device to the Powerline Network | 15 |
| 3.2.2. Change Powerline Network Name..... | 16 |
| 3.3. Wi-Fi Move | 17 |
| 3.4. Wi-Fi Clone | 17 |
| 3.5. Wireless Network..... | 19 |
| 3.5.1. Customize Wireless Settings | 19 |
| 3.5.2. Wireless Clients | 21 |
| 3.6. LED Schedules | 21 |
| 3.7. Schedule Your Wireless Function | 23 |
| 3.8. Parental Controls | 25 |
| 3.9. Guest Network..... | 27 |
| 3.10. MAC Filter | 28 |
| 3.11. Administration..... | 30 |
| 3.11.1. LAN IP Address..... | 30 |
| 3.11.2. Set Up System Time..... | 30 |
| 3.11.3. Upgrade the Firmware | 32 |
| 3.11.4. Backup and Restore Configuration Settings..... | 32 |
| 3.11.5. System Log | 34 |

| | |
|---|-----------|
| Chapter 4. OneMesh™ with Seamless Roaming..... | 35 |
| 4. 1. What's a OneMesh™ Network..... | 36 |
| Unified OneMesh™ Network | 36 |
| 4. 2. How to Set Up a OneMesh™ Network | 37 |

About This Guide

This guide is a complement to Quick Installation Guide. The Quick Installation Guide provides instructions for quick internet setup, while this guide contains details of each function and demonstrates how to configure them in typical scenarios.

Features available in the powerline may vary by model and software version. Powerline availability may also vary by region or ISP. All images, steps, and descriptions in this guide are only examples and may not reflect your actual experience.

Conventions

In this guide the following conventions are used:

| Convention | Description |
|-------------------------|---|
| Powerline extender | Stands for AV1300 Powerline ac Wi-Fi Extender without any explanation. |
| <u>Teal Underlined</u> | Hyperlinks are in teal and underlined. You can click to redirect to a website or a specific section. |
| Teal | Key information appears in teal, including management page text such as menus, items, buttons and so on. |
| > | The menu structures to show the path to load the corresponding page. For example, Wireless > MAC Filter means the MAC Filter function page is under the Wireless menu. |
| ■ Note: | Ignoring this type of note might result in a malfunction or damage to the device. |
| 🔗 Tips: | Indicates important information that helps you make better use of your device. |
| Symbols on the web page | <ul style="list-style-type: none">✎ click to edit the corresponding entry.🗑 click to delete the corresponding entry.🔗 click to enable or disable the corresponding entry. |

*Compatible with all HomePlug AV and AV2 Standard Powerline adapters. This product may not be compatible with routers or gateways with firmware that has been altered, is based on open source programs, or are non-standard or outdated.

*Maximum wireless signal rates are the physical rates derived from IEEE Standard 802.11 specifications. Actual wireless data throughput and wireless coverage are not guaranteed and will vary as a result of 1) environmental factors, including building materials, physical objects, and obstacles, 2) network conditions, including local interference, volume and density of traffic, product location, network complexity, and network overhead, and 3) client limitations, including rated performance, location, connection, quality, and client condition.

*Maximum Powerline signal rates are the physical rates derived from HomeplugAV/AV2 specifications. Actual Powerline data throughput and Powerline range are not

guaranteed and will vary as a result of network conditions and environmental factors, including electrical interference, volume of traffic and network overhead, AFCI circuit breaker, and Powerline being located in a separate circuit.

More Info

- The latest software, management app and utility are available from the [Download Center](#) at <https://www.tp-link.com/support/download>.
- The Quick Installation Guide (QIG) can be found where you find this guide or inside the package of the powerline extender.
- Specifications can be found on the product page at <https://www.tp-link.com>.
- TP-Link Community is provided for you to share knowledge and discuss our products at <https://community.tp-link.com/>.
- Our Technical Support contact information can be found at the [Contact Technical Support](#) page at <https://www.tp-link.com/support>.

Chapter 1

Get to Know Your Powerline Extender

This chapter introduces what the powerline extender can do and describes its main features and appearance.

It contains the following sections:

- [Product Overview](#)
- [Product Appearance](#)

1.1. Product Overview

TP-Link's Powerline Wi-Fi Extender is a combined wired/wireless network expansion device. With the help of your home's existing electrical circuitry, it can extend your Wi-Fi to wherever you want in your house.

With Ethernet ports and built-in antennas, the powerline Wi-Fi extender provides wired and wireless access for multiple computers and mobile devices.

With various features and functions, the powerline Wi-Fi extender is the perfect choice for your home or business network.

1.2. Product Appearance



Your powerline extender may differ in appearance slightly from that depicted because of the region and product version.

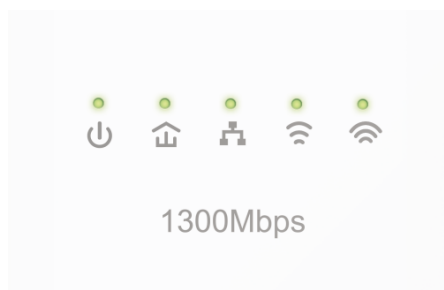

■ Note: The European version is used for demonstration in this User Guide.

1.2.1. LED Legend



LEDs indicate the powerline extender's working status. For more details, please refer to the following table.

| Name | Status | Indication |
|---|----------|---|
|  Power | On/Off | Power is on/off. |
| | Blinking | Pairing is in progress. |
|  Powerline | On | The powerline extender is connected to the powerline network and is in a suitable location. |
| | Off | The powerline extender is not connected to the powerline network. |
|  Ethernet | On | At least one LAN port is connected to a powered-on device. |
| | Off | No LAN port is connected to a powered-on device. |

| Name | Status | Indication |
|---|----------|--|
|  2.4GHz Wireless | On | The 2.4GHz wireless band is enabled. |
| | Off | The 2.4GHz wireless band is disabled. |
| | Flashing | The powerline extender is cloning 2.4GHz wireless network settings from the main router. |
|  5GHz Wireless | On | The 5GHz wireless band is enabled. |
| | Off | The 5GHz wireless band is disabled. |
| | Flashing | The powerline extender is cloning 5GHz wireless network settings from the main router. |

1.2.2. Physical Interface

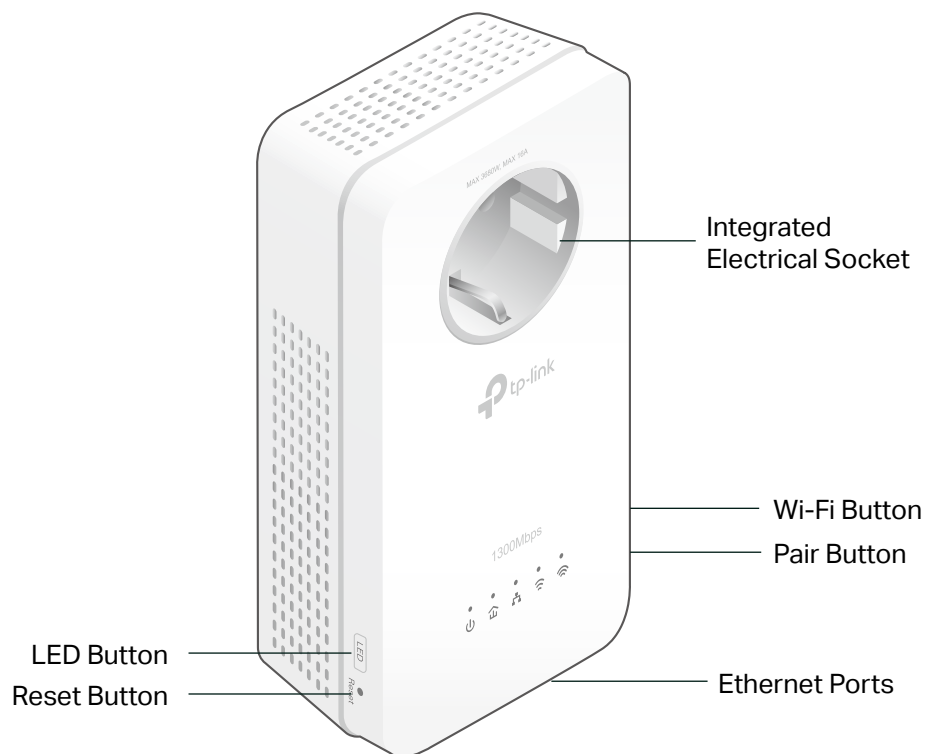

Integrated Electrical Socket

Used as a pass-through AC outlet to power other devices. Its built-in noise filter also reduces some electrical noise that may interfere with powerline performance.

Wi-Fi Button

Press and hold the button for 1 second to begin or stop copying Wi-Fi settings from the router. Go to [Wi-Fi Clone](#) for more information.

Press and hold the button for at least 5 seconds to turn the wireless function on or off. The wireless function is on by default.

Pair Button

Press and hold the button for 1 second on two powerline devices within two minutes to join a powerline network. Go to [To Set Up a New Secure Wireless Network](#) for more information.

Ethernet Port

Connect the Ethernet ports to your wired devices, such as a computer, a router or a game console, via Ethernet cables.

LED Button

Press and hold the button for 1 second to turn all LEDs on or off. All LEDs are on by default. If you don't feel like being bothered by the LED light at night, press and hold the button for 1 second to turn all LEDs off. The next morning, just press and hold the button again to turn them on.

Reset

Press and hold the Reset button for at least 5 seconds to reset the powerline extender to factory default settings.

Note:

1. Use the product in below directions.

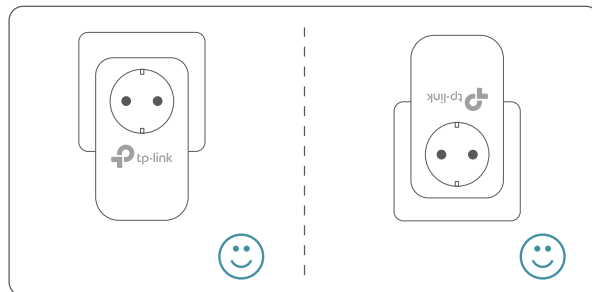

2. Plug the product directly into a wall socket instead of a power strip.

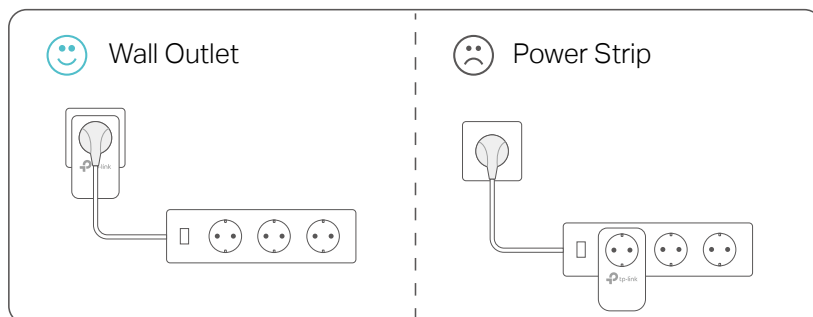

Chapter 2

Initial Use

This chapter guides you on how to use the powerline extender when you first open the package.

It contains the following sections:

- [To Set Up a New Secure Wireless Network](#)
- [To Extend the Existing Wireless Network](#)

2.1. To Set Up a New Secure Wireless Network

I want to:

Use the Powerline Wi-Fi Kit to set up a new secure wireless network in my house.

For example, I have a wireless router in my house, but the wireless signal cannot reach every corner. So I bought a Powerline Wi-Fi Kit to extend the wireless network. The Powerline Wi-Fi Kit includes a powerline adapter and a powerline extender.

How can I do that?

Method 1: Plug and Play

1. Connect the powerline adapter to an available LAN port of the router.
2. Plug the powerline adapter into a wall socket.
3. Plug the powerline extender into a wall socket near the adapter. Wait until the extender's Powerline LED  turns solid on.

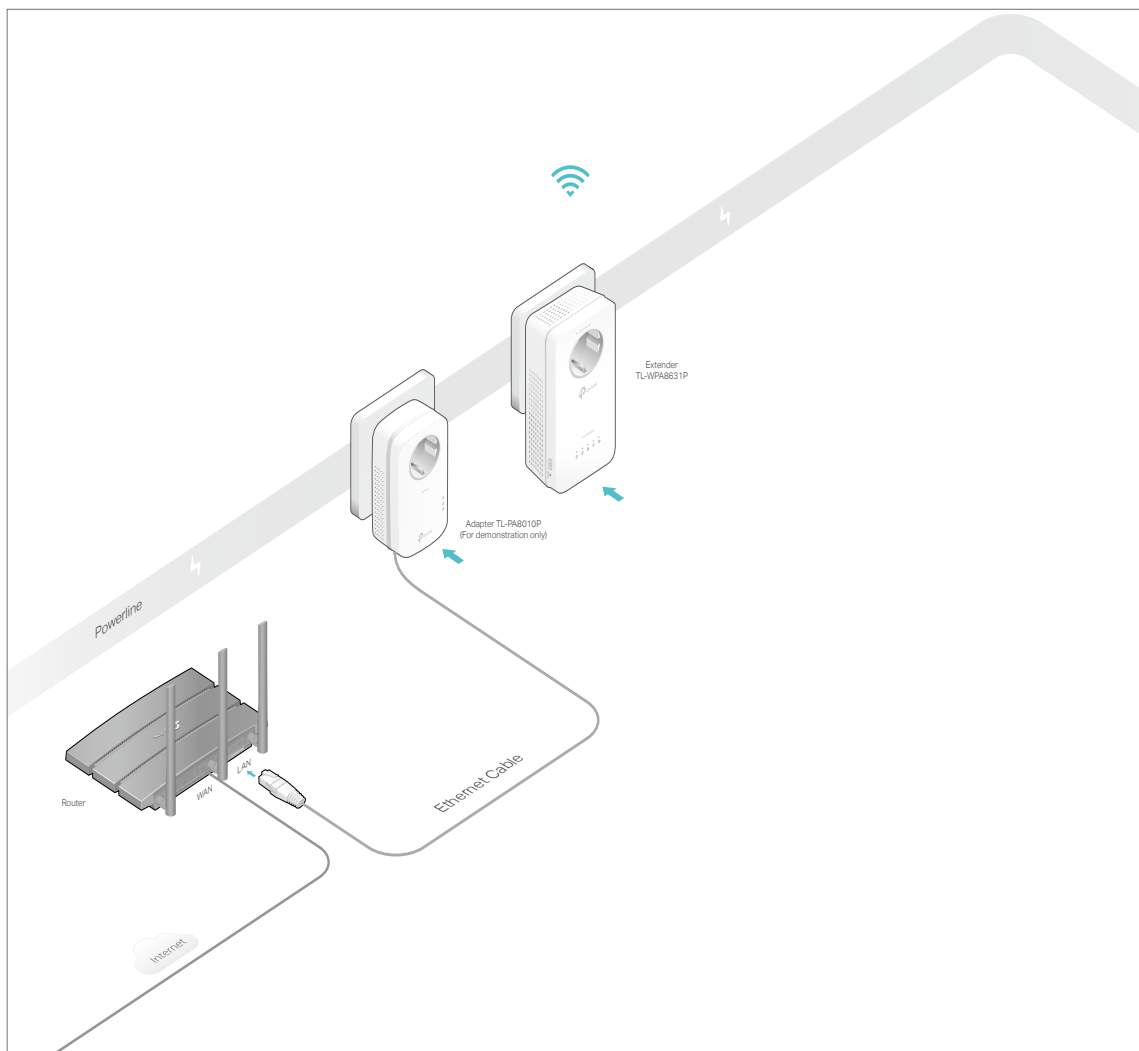

- Relocate the new extender to the Wi-Fi "dead" zone. Connect your devices to the internet using the SSIDs (network name) and password printed on the label at the side of the extender.

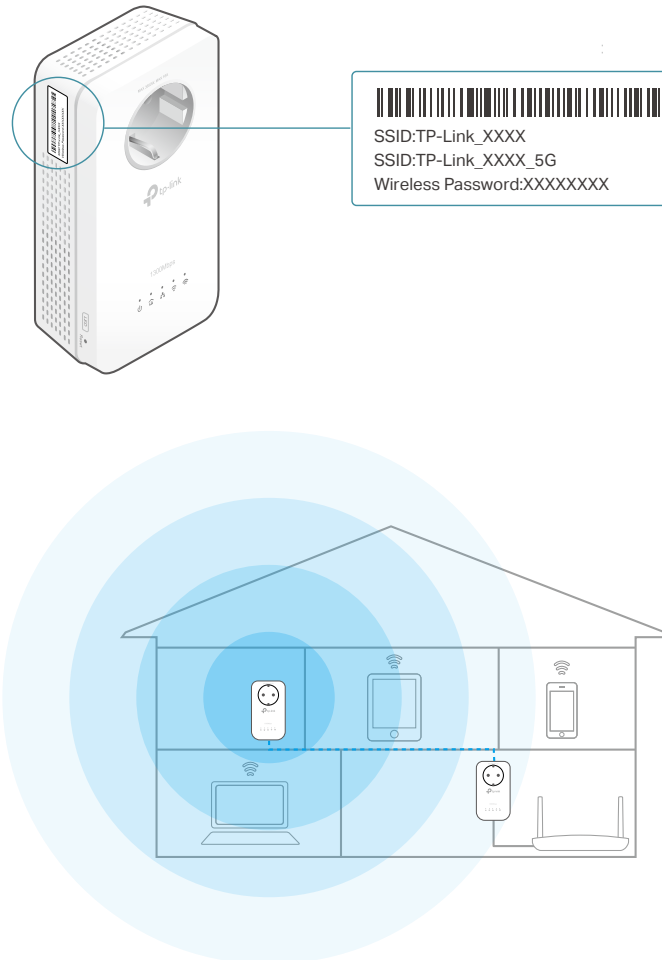

Done!

Now enjoy the internet with the SSIDs and password printed on the label!

Method 2: Pairing

- Connect the powerline adapter to an available LAN port of the router.
- Plug the powerline adapter into a wall socket.
- Plug the powerline extender into a wall socket near the adapter.
- Pair the powerline devices.
 - Press the Pair button of the powerline adapter for 1 second. The Power LED should start blinking.
Note: If the Power LED does not blink, press the Pair button again.

- b. (Within two minutes) press the Pair button of the powerline extender for 1 second. The Power LED should start blinking. When the extender's Powerline LED  turns on, the pairing process is done!

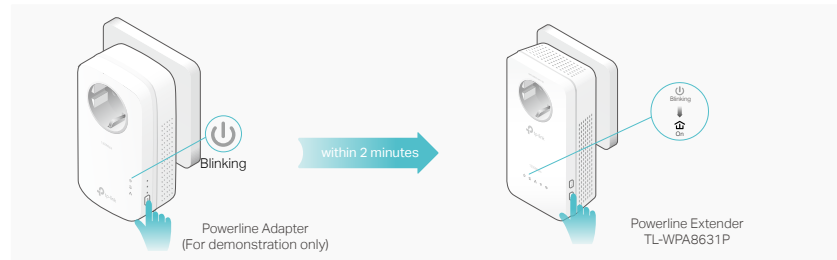

5. Relocate the new extender to the Wi-Fi "dead" zone. Connect your devices to the internet using the SSIDs (network name) and password printed on the label at the side of the extender.

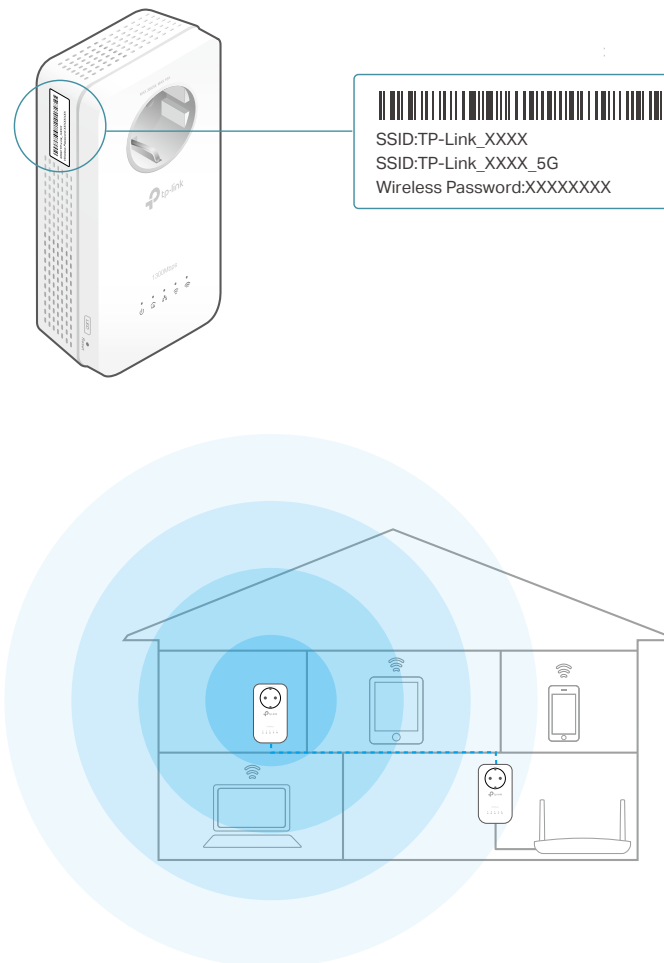

Done!

Now enjoy the internet with the SSIDs and password printed on the label!

2.2. To Extend the Existing Wireless Network

I want to:

Extend the existing wireless network by adding a new powerline extender into the existing powerline network.

For example, I already set up a wireless network using powerline devices, but the wireless network is still not big enough to reach the top floor. So I bought a new powerline extender to extend the wireless network.

How can I do that?

1. Plug the new powerline extender into a wall socket near one of the existing powerline extender.

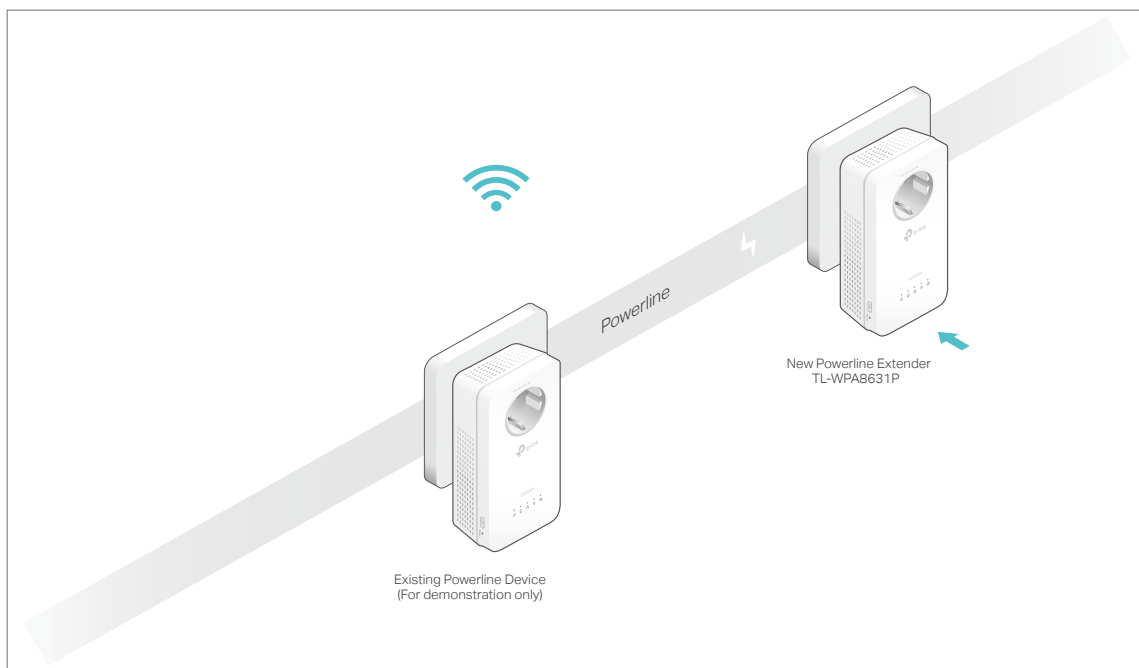

2. Check the new extender's Powerline LED . Is it on?
 - If it is on, follow Step 4 > A.
 - If it is off, follow Step 3 and Step 4 > B.
3. Join the new powerline extender into the existing powerline network by pairing two powerline devices.
 - a. Press the Pair button on the existing powerline device for 1 second. The Power LED should start blinking.
 - Note: If the Power LED does not blink, press again.
 - b. Within two minutes, press the Pair button on the new powerline extender for 1 second. The Power LED should start blinking. When the Powerline LED turns on, the pairing process is complete.

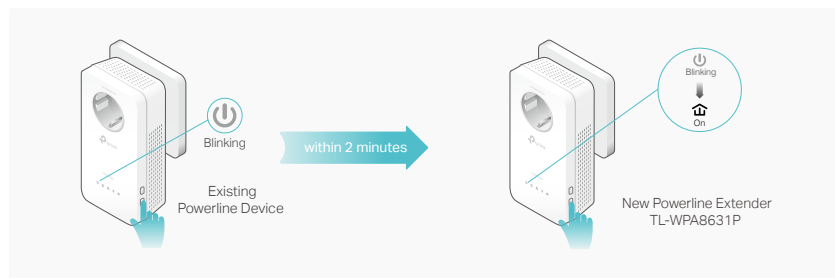

4. Relocate the new extender to the Wi-Fi “dead” zone.

- A . Use the SSIDs (network name) and password on the label at the side of the new extender to connect to the internet.
- B . Use the SSID (network name) and password of your existing wireless network to connect.

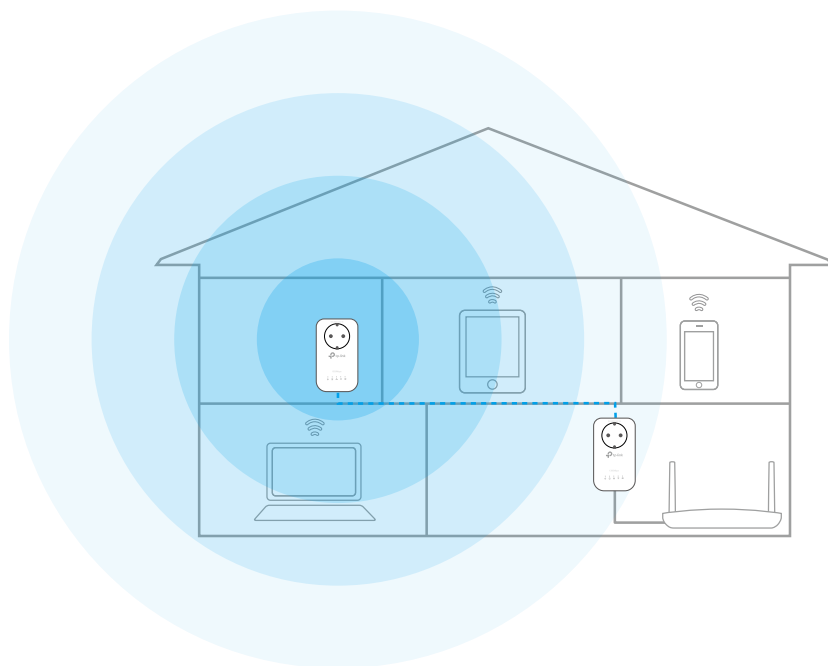

Done!

Enjoy the internet through your extended network!

Chapter 3

Configuring via Web Management Interface

The powerline extender has a management interface to configure all settings. The management interface can be opened on any device that has a web browser, such as Internet Explorer, Chrome or Firefox. This chapter is going to give detailed information on what functions the powerline extender has and how to configure them.

It contains the following sections:

- [Management Interface](#)
- [Manage Powerline Network](#)
- [Wi-Fi Move](#)
- [Wi-Fi Clone](#)
- [Wireless Network](#)
- [LED Schedules](#)
- [Schedule Your Wireless Function](#)
- [Parental Controls](#)
- [Guest Network](#)
- [MAC Filter](#)
- [Administration](#)

3. 1. Management Interface

3. 1. 1. Log In

There are two methods to log in to the management interface.

Method 1: Via web browser

Follow the steps below:

1. Connect your device to the powerline extender wirelessly.
2. Launch a web browser and type in <http://tplinkplc.net> to open the management interface.

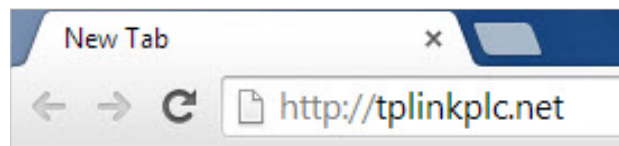

3. Create a password for future login attempts.

Method 2: Via tpPLC utility

Follow the steps below:

1. Connect your computer to the powerline extender via an Ethernet cable or wirelessly.
2. Obtain and install the tpPLC Utility from the product's Support page at <https://www.tp-link.com>.
3. Open the utility, move your mouse over your powerline extender, and click the  icon that appears beside it.
4. Create a password for future login attempts.

Method 3: Via tpPLC app

Follow the steps below:

1. Get the tpPLC app from the Apple App Store or Google Play, or simply scan the QR code.



2. Connect your device to the powerline extender wirelessly.
3. Launch the tpPLC app and find the model of your device.
4. Manage your powerline extender as needed.

3.1.2. Change the Login Account

Follow the steps below to change the account.

1. Go to [System Tools > Administration](#).
2. Follow instructions on the page to set a new password. A strong password should be at least 8 characters in length, combining uppercase and lowercase letters, numbers and punctuations.



The screenshot shows a web form titled "Account Management". It contains three input fields: "Old Password:", "New Password:", and "Confirm New Password:". The "New Password:" field has a strength indicator below it with three segments labeled "Low", "Middle", and "High". A teal "Save" button is located in the bottom right corner of the form.

3. Click [Save](#) to make the settings effective.

3.2. Manage Powerline Network

A powerline network is formed of powerline devices, including adapters and extenders. Powerline devices in the same powerline network share the same powerline network name.

3.2.1. Add a New Device to the Powerline Network

1. Connect to the powerline extender wirelessly. Visit <http://tplinkplc.net>, and log in with the password you set for the extender.
2. Go to the [Status](#) page. Click the [Powerline Network](#) icon to see the Powerline Device List.

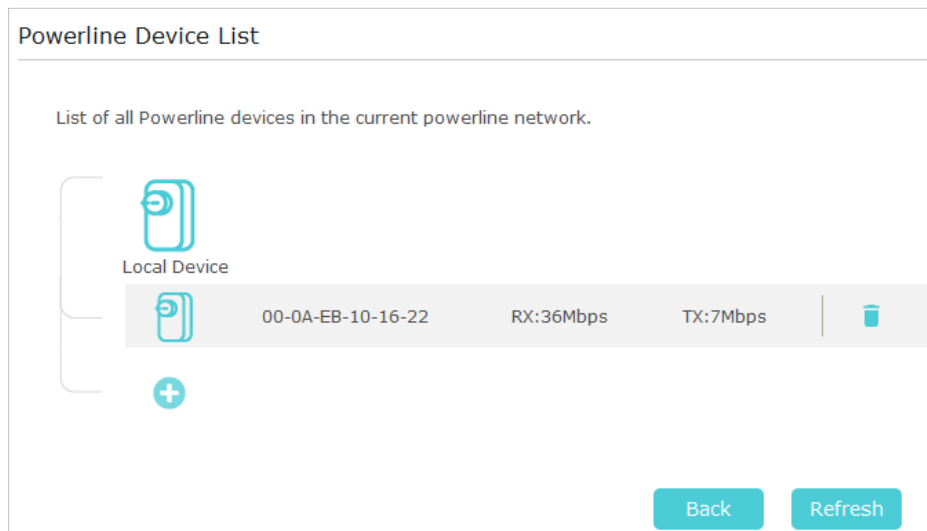

3. Click the **add** icon and enter the **Powerline Key** of the device you want to add. The Powerline Key contains 16 capital letters, formed like XXXX-XXXX-XXXX-XXXX. It is printed on the back of the powerline device.

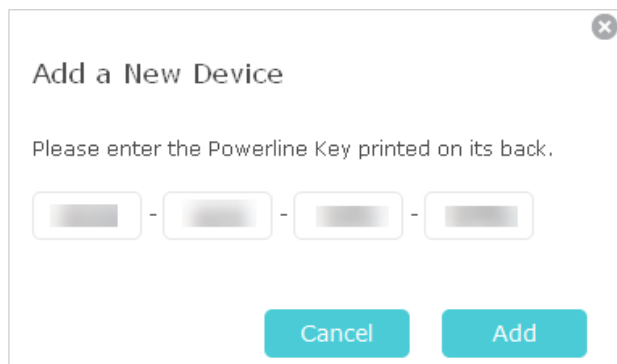

4. Click **Add** to add the device.

3. 2. 2. Change Powerline Network Name

You can change the extender's powerline network name to add it to or remove it from a powerline network.

Follow the steps below to change the name.

1. Connect to the powerline extender wirelessly. Visit <http://tplinkplc.net>, and log in with the password you set for the extender.
2. Go to **Device Settings > Powerline**.

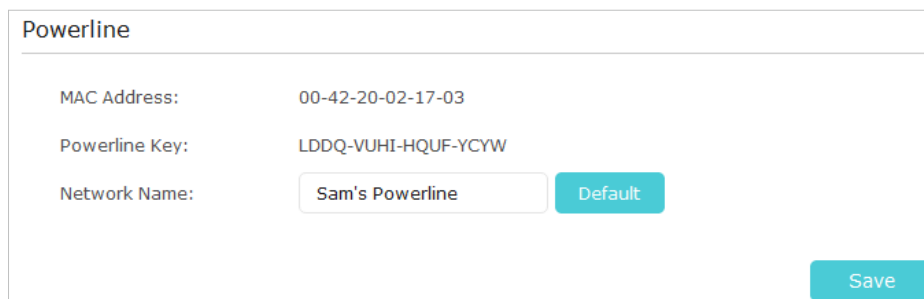

Powerline

MAC Address: 00-42-20-02-17-03

Powerline Key: LDDQ-VUHI-HQUF-YCYW

Network Name:

3. Change the **Network Name**. You can also click **Default** to use the default network name, e.g. HomePlugAV. However, if the default name is used, the Wi-Fi Move function will be automatically disabled.

4. Click **Save** to make the settings effective.

3.3. Wi-Fi Move

Wi-Fi Move is enabled by default. With the feature enabled, any changes made to the Wi-Fi settings of one powerline extender will be automatically synchronized to other powerline extenders whose Wi-Fi Move feature is also enabled on the same powerline network.

Follow the steps below to enable the Wi-Fi Move feature:

1. Connect to the powerline extender wirelessly. Visit <http://tplinkplc.net>, and log in with the password you set for the extender.
2. Go to **Wireless > Wi-Fi Move**.
3. Toggle **On** to enable the feature.

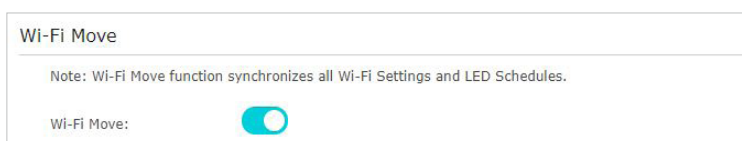

Wi-Fi Move

Note: Wi-Fi Move function synchronizes all Wi-Fi Settings and LED Schedules.

Wi-Fi Move:

Note:

When Wi-Fi Move is enabled, the following features will be synced: Wireless SSID & Password, Wireless Security, Wireless Mode, Wireless Radio Status, Wi-Fi Schedules, LED Schedules, Wi-Fi Clone Settings, MAC Filter Settings, Parental Controls and Guest Network.

3.4. Wi-Fi Clone

I want to:

Copy wireless settings from my router to my extender, so I can use the same SSID and password to access the internet in my house.

How can I do that?

1. Connect to the powerline extender wirelessly. Visit <http://tplinkplc.net>, and log in with the password you set for the extender.
2. Go to **Wireless > Wi-Fi Clone**.
3. Select a Wi-Fi band or both to be cloned. **2.4GHz & 5GHz** is selected by default.

Wi-Fi Band Selection

Select one or both to be cloned.

2.4GHz & 5GHz

2.4GHz

5GHz

Save

4. Before cloning, make sure your router supports the same band as your extender. If you do not know how to check this, go to your router's User Guide for more information.
5. Plug your extender near your router.
6. Press the **WPS** button on your router.

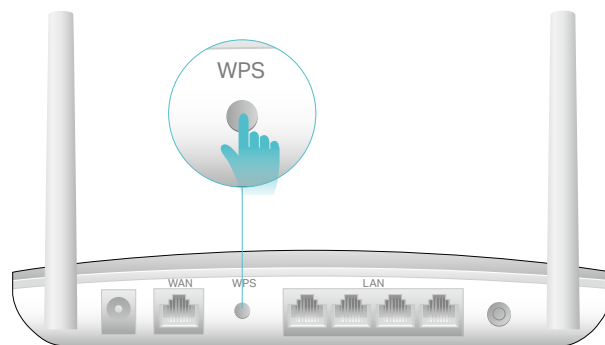

Wireless Router

7. Within two minutes, press the **Wi-Fi** button on the side panel of the extender.

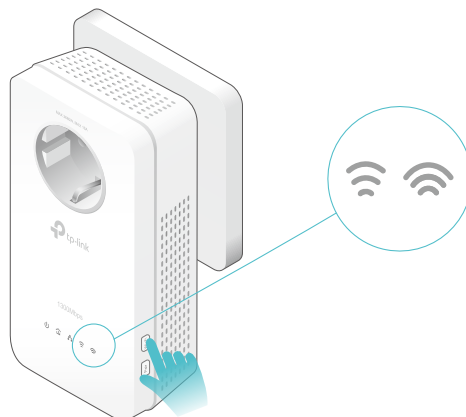

Done!

When the corresponding Wi-Fi LED blinks quickly for 3 seconds and then stays on. It's done!

3.5. Wireless Network

3.5.1. Customize Wireless Settings

The powerline extender's wireless network name (SSID) and password, and security option are preset in the factory. The preset SSID and password can be found on the product label and Wi-Fi Info Card. You can customize the wireless settings according to your needs.

1. Connect to the powerline extender wirelessly. Visit <http://tplinkplc.net>, and log in with the password you set for the extender.
2. Go to [Wireless](#) > [Settings](#) page.

- **To enable or disable the wireless function:**

Select the box to enable the wireless Radio of 2.4GHz or 5GHz. Deselect the box to disable wireless function. If disabled, all wireless settings will be ineffective.

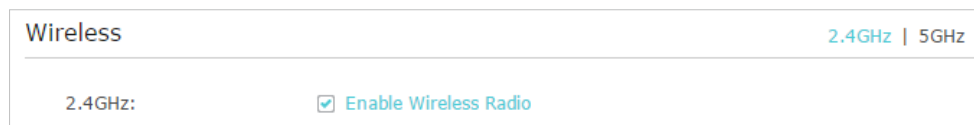

The screenshot shows a web interface for wireless settings. At the top, there is a header "Wireless" on the left and "2.4GHz | 5GHz" on the right. Below this, there is a section for "2.4GHz:" with a checked checkbox labeled "Enable Wireless Radio".

- **To change the wireless network name (SSID) and wireless password:**

The default SSID is TP-Link_XXXX for 2.4GHz network and TP-Link_XXXX_5G for 5GHz network, and the default password is printed on the label at the side panel of the extender. You can change the default ones by directly entering new ones in the field. SSID is up to 32 characters, and the value in both SSID and password is case-sensitive.

Note:

Remember to write down the new SSID and password, for you may be disconnected when new settings are effective.



The screenshot shows two input fields. The first is labeled "Network Name (SSID):" and contains the text "TP-Link_1702". The second is labeled "Password:" and contains the text "12345670".

To hide SSID:

Select Hide SSID, and your SSID will not be broadcasted. It won't display when you scan for local wireless network list on your wireless device and you need to manually join the network.

| | | |
|----------------------|--------------|---|
| Network Name (SSID): | TP-Link_1702 | <input checked="" type="checkbox"/> Hide SSID |
|----------------------|--------------|---|

To have more advanced settings

Click [Advanced](#) below [Password](#) to have more advanced settings.

| |
|--|
|  Advanced |
|--|

| | |
|-----------------|--|
| Security: | WPA/WPA2-Personal (Recommended) ▼ |
| Version: | <input checked="" type="radio"/> Auto <input type="radio"/> WPA-PSK <input type="radio"/> WPA2-PSK |
| Encryption: | <input type="radio"/> Auto <input type="radio"/> TKIP <input checked="" type="radio"/> AES |
| Mode: | 802.11b/g/n mixed ▼ |
| Channel Width: | <input checked="" type="radio"/> Auto <input type="radio"/> 20MHz <input type="radio"/> 40MHz |
| Channel: | Auto ▼ |
| Transmit Power: | <input type="radio"/> Low <input type="radio"/> Middle <input checked="" type="radio"/> High |

Security: Select an option from the Security drop-down list. The extender provides three options, No Security, WPA/WPA2 Personal (Recommended), and WEP. WPA2 uses the newest standard and the security level is the highest. We don't recommend you to change the default settings unless necessary.

Mode: Select the desired mode.

- 802.11n only: Select only if all of your wireless clients are 802.11n devices.
- 802.11g/n mixed: Select if you are using both 802.11g and 802.11n wireless clients.
- 802.11b/g/n mixed: Select if you are using a mix of 802.11b, 11g, and 11n wireless clients.

Note: When 802.11n only mode is selected, only 802.11n wireless clients can connect to the extender. It is strongly recommended that you select 802.11b/g/n mixed, and all of 802.11b, 802.11g, and 802.11n wireless clients can connect to the extender.

- 802.11ac only (5GHz): Select only if all of your wireless clients are 802.11ac devices.
- 802.11n/ac mixed (5GHz): Select if you are using both 802.11n and 802.11ac wireless clients.
- 802.11a/n/ac mixed (5GHz): Select if you are using a mix of 802.11ac, 802.11n and 802.11ac wireless clients. It is strongly recommended that you select 11a/n/ac mixed.

Channel Width: Select the channel width. The default setting is Auto, which can adjust the channel width for your clients automatically.

Channel: Select the channel you want to use from the drop-down list. This field determines which operating frequency will be used. It is not necessary to change the wireless channel unless you notice interference problems with another nearby access point.

Transmit Power: Select the level of transmit power. We recommend you choose **High** to have the best signal strength.

3.5.2. Wireless Clients

Follow the steps below to view detailed information of all wireless clients connected to the extender.

1. Connect to the powerline extender wirelessly. Visit <http://tplinkplc.net>, and log in with the password you set for the extender.
2. Go to **Wireless > Clients** page.

| Online Wireless Clients | | | | | |
|-------------------------|-------------|---------------|-------------------|---------------|---|
| Total Clients: 1 | | | | |  Refresh |
| ID | Device Name | IP Address | MAC Address | Wireless Band | Security |
| 1 | TP-Link | 192.168.0.101 | CC-08-8D-19-0A-35 | 2.4GHz | WPA2-PSK |

3. Now you can view the detailed information, including device name, IP address, MAC address, connected wireless band and security type.

 **Tips:** You can also see the wireless details by clicking the wireless clients icon on **Status > Wireless Clients**.

3.6. LED Schedules

I want to:

Automatically turn off LEDs at times when I do not want light in my room.

For example, I want to turn LEDs off everyday from 00:00am to 7:00am.

How can I do that?

1. Connect to the powerline extender wirelessly. Visit <http://tplinkplc.net> and log in with the password you set.
2. Go to **Device Settings > LED Schedules**.
3. Toggle **On** to enable the LED Scheduler. If you are prompted like the following picture, click **OK**.

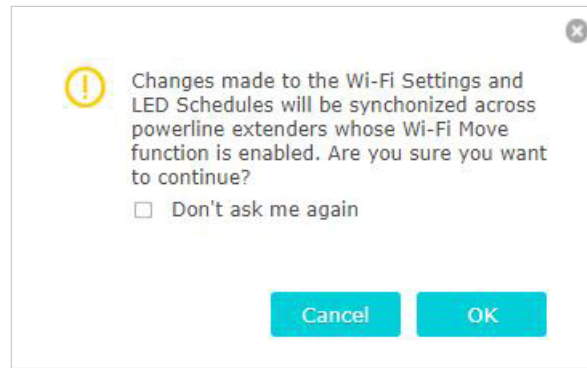

LED Schedules

Note: Please make sure the time settings are correct before using this function.

LED Scheduler:

LED Off Schedules

Note: Any changes made to LED Schedules will be synchronized across powerline extenders whose Wi-Fi Move function is enabled. Be careful to make changes.

[+ Add](#) [- Delete](#)

| <input type="checkbox"/> | ID | From | To | Day(s) | Status | Modify |
|--------------------------|----|------|----|--------|--------|--------|
| <input type="checkbox"/> | -- | -- | -- | -- | -- | -- |

4. Click [Add](#) to add an entry.
5. Choose [LED Off Time](#) from 00:00 to 7:00, and then check all boxes from Sunday to Saturday.
 - **Note:** Please make sure that the system time is correct before using this function.
6. Click [Enable this entry](#) to make it effective.

LED Off Schedules

Note: Any changes made to LED Schedules will be synchronized across powerline extenders whose Wi-Fi Move function is enabled. Be careful to make changes.

+ Add - Delete

| <input type="checkbox"/> | ID | From | To | Day(s) | Status | Modify |
|--------------------------|----|------|----|--------|--------|--------|
| -- | -- | -- | -- | -- | -- | -- |

LED Off Time: 0:00 - 7:00

Repeat Every: Sun. Mon. Tue. Wed. Thu. Fri. Sat.

Enable this entry

Cancel
OK

7. Click **OK** to save the settings.

Done!

Now your LEDs will be turned off automatically at 00:00 and turned on at 7:00am the next morning.

3. 7. Schedule Your Wireless Function

I want to:

Automatically turn off my wireless network at times when I do not need the wireless connection.

For example, I want to turn them off from 00:00am to 7:00am. Yet if I have my wireless devices connected to the extender at that time, I want the wireless on till all devices are disconnected from the internet.

How can I do that?

1. Connect to the powerline extender wirelessly. Visit <http://tplinkplc.net> and log in with the password you set.
2. Go to [Wireless](#) > [Wi-Fi Schedules](#).

Wi-Fi Schedules

Note: Please make sure the time settings are correct before using this function.

Wi-Fi Scheduler:

Do not turn off Wi-Fi while clients are connected to it.

[Save](#)

Wi-Fi Off Schedules

Note: Any changes made to Wi-Fi Schedules will be synchronized across powerline extenders whose Wi-Fi Move function is enabled. Be careful to make changes.

[+ Add](#) [- Delete](#)

| <input type="checkbox"/> | ID | From | To | Day(s) | Status | Modify |
|--------------------------|----|------|----|--------|--------|--------|
| <input type="checkbox"/> | -- | -- | -- | -- | -- | -- |

3. Toggle **On** to enable the Wi-Fi Scheduler. If you are prompted like the following picture, click **Continue**.

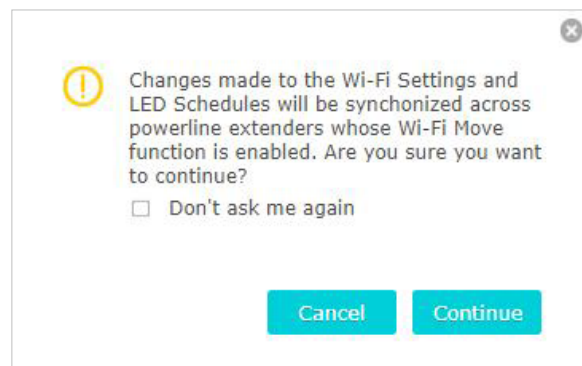

4. Check the box of **Do not turn off Wi-Fi while clients are connected to it** and click **Save**.
5. Click **Add** to add an entry.
6. Choose 00:00 and 7:00 from the drop-down list. Check all boxes from Sunday to Saturday.
 - **Note:** Please make sure that the system time is correct before using this function.
7. Click **Enable this entry** to make it effective.

Wi-Fi Off Schedules

+ Add - Delete

| <input type="checkbox"/> | ID | From | To | Day(s) | Status | Modify |
|--------------------------|----|------|----|--------|--------|--------|
| <input type="checkbox"/> | -- | -- | -- | -- | -- | -- |

Wi-Fi Off Time: 0:00 - 7:00

Repeat Every: Sun. Mon. Tue. Wed. Thu. Fri. Sat.

Enable this entry

Cancel OK

8. Click **OK** to save the settings.

Done!

Now your Wi-Fi will be automatically turned off at 00:00 and turned on at 7:00am the next morning.

Note:

The Wi-Fi LED will turn off if the wireless network is disabled.

3. 8. Parental Controls

I want to:

Control when my children's wireless devices can access the internet.

For example, I want to allow my children's wireless devices to access only from 18:00 (6PM) to 22:00 (10PM) on weekdays and not other times.

How can I do that?

1. Connect to the powerline extender wirelessly. Visit <http://tplinkplc.net>, and log in with the password you set for the extender.
2. Go to [Parental Controls](#).

Parental Controls

Parental Controls:

Devices Under Parental Controls

+ Add - Delete

| <input type="checkbox"/> | ID | MAC Address | Internet Access Time | Description | Status | Modify |
|--------------------------|----|-------------|----------------------|-------------|--------|--------|
| <input type="checkbox"/> | -- | -- | -- | -- | -- | -- |

3. Toggle **On** to enable Parental Controls. If you are prompted like the following picture, click **Continue**.

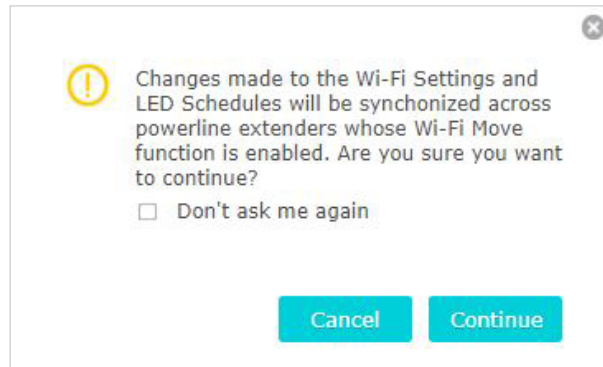

4. Click **Add**.

Devices Under Parental Controls

+ Add - Delete

| <input type="checkbox"/> | ID | MAC Address | Internet Access Time | Description | Status | Modify |
|--------------------------|----|-------------|----------------------|-------------|--------|--------|
| -- | -- | -- | -- | -- | -- | -- |

MAC Address: [View Existing Devices](#)

Internet Access Time:

Description: (Optional)

[Enable this Entry](#)

[Cancel](#) [OK](#)

5. Click **View Existing Devices**, and select the device to be controlled. Or, enter the **MAC Address** manually.
6. Click the icon to set the Internet Access Time. Drag the cursor over the appropriate cell(s) and click **Save**.

Note: Please make sure that the system time is correct before using this function.

| Time | Monday | Tuesday | Wednesday | Thursday | Friday | Saturday | Sunday |
|-------|----------------------|----------------------|----------------------|----------------------|----------------------|----------|--------|
| 00:00 | | | | | | | |
| 01:00 | | | | | | | |
| 02:00 | | | | | | | |
| 03:00 | | | | | | | |
| 04:00 | | | | | | | |
| 05:00 | | | | | | | |
| 06:00 | | | | | | | |
| 07:00 | | | | | | | |
| 08:00 | | | | | | | |
| 09:00 | | | | | | | |
| 10:00 | | | | | | | |
| 11:00 | | | | | | | |
| 12:00 | | | | | | | |
| 13:00 | | | | | | | |
| 14:00 | | | | | | | |
| 15:00 | | | | | | | |
| 16:00 | | | | | | | |
| 17:00 | | | | | | | |
| 18:00 | Internet Access Time | Internet Access Time | Internet Access Time | Internet Access Time | Internet Access Time | | |
| 19:00 | Internet Access Time | Internet Access Time | Internet Access Time | Internet Access Time | Internet Access Time | | |
| 20:00 | Internet Access Time | Internet Access Time | Internet Access Time | Internet Access Time | Internet Access Time | | |
| 21:00 | Internet Access Time | Internet Access Time | Internet Access Time | Internet Access Time | Internet Access Time | | |
| 22:00 | Internet Access Time | Internet Access Time | Internet Access Time | Internet Access Time | Internet Access Time | | |
| 23:00 | | | | | | | |
| 24:00 | | | | | | | |

Legend: ■ Internet Access Time

Buttons: Cancel, Reset, Save

7. Enter a **Description** for the entry.
8. Click **Enable this entry** to make it effective.
9. Click **OK** to save the settings.

Done!

Now the controlled device can access only from 18:00 (6PM) to 22:00 (10PM) on weekdays and not other times.

3.9. Guest Network

I want to:

Create a network for my guests, providing internet access for them while at the same time limit the network authorities for guests to ensure network security and privacy.

How can I do that?

1. Connect to the powerline extender wirelessly. Visit <http://tplinkplc.net>, and log in with the password you set for the extender.
2. Go to **Guest Network**.
3. Check the box of relative entry to limit network authorities. If you have problems understanding these items, click the question mark on the upper right corner to have more information.

4. Click **Save** to make the settings effective.

5. Click **2.4GHz** or **5GHz** to choose a wireless band, and configure the following settings.

- **To enable or disable the guest network function:**

Select the box to enable the guest network function. Deselect the box to disable guest network function. If disabled, all guest network settings of the corresponding band will be ineffective.

- **To change the guest network name (SSID) and password:**

The default SSID is TP-Link_Guest_XXXX for 2.4GHz guest network and TP-Link_Guest_XXXX_5G for 5GHz guest network. The default password is the same as the host network's, which is printed on the label at the side panel of the extender. You can change the default ones by directly entering new ones in the field. SSID is up to 32 characters, and the value in both SSID and password is case-sensitive.

Done!

Now you can tell your guests to connect to the guest network you created.

3. 10. MAC Filter

This function exploits the uniqueness of the MAC (Medium Access Control) address, a unique 12-digit hexadecimal address (for example, D8-5D-4C-B4-46-EA) of every network device, to determine if the device can or cannot access your wireless network.

I want to:

Prevent unauthorized users from accessing my wireless network by utilizing the network

device's MAC address.

For example, I have a computer that is connected to my wireless network. Now, an unknown device (an intruder) is also using my wireless network, which affects my internet speed. I would like to control my wireless network with the following capabilities:

- My computer is always allowed to access the wireless network.
- The unknown device is not allowed to access the wireless network.
- I don't have to keep changing my wireless password as often.

How can I do that?

1. Connect to the powerline extender wirelessly. Visit <http://tplinkplc.net>, and log in with the password you set for the extender.
2. Go to **Wireless** > **MAC Filter**.
3. Toggle **On** to enable MAC Filter. If you are prompted like the following picture, click **Continue**.
4. Select either of the filtering rules and click **Save**. Here we select **Block wireless access from the devices listed below** and then click **Save**.

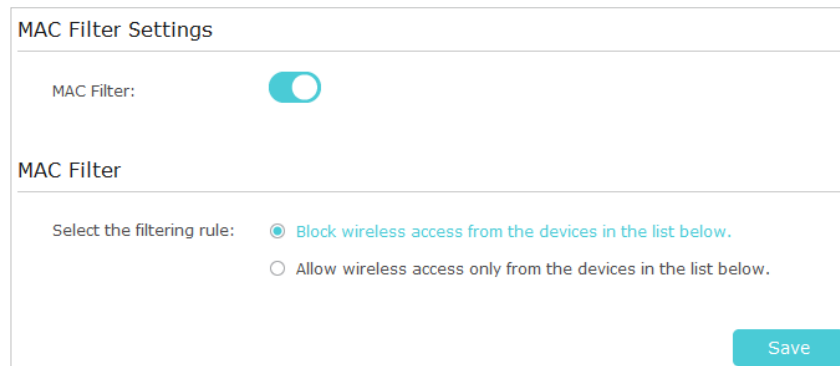

The screenshot shows the 'MAC Filter Settings' page. At the top, there is a section for 'MAC Filter' with a toggle switch that is turned on. Below this, there is a section for 'MAC Filter' with two radio button options: 'Block wireless access from the devices in the list below.' (which is selected) and 'Allow wireless access only from the devices in the list below.'. A 'Save' button is located at the bottom right of the form.

5. Click **Add** under Device List to add devices to the list.

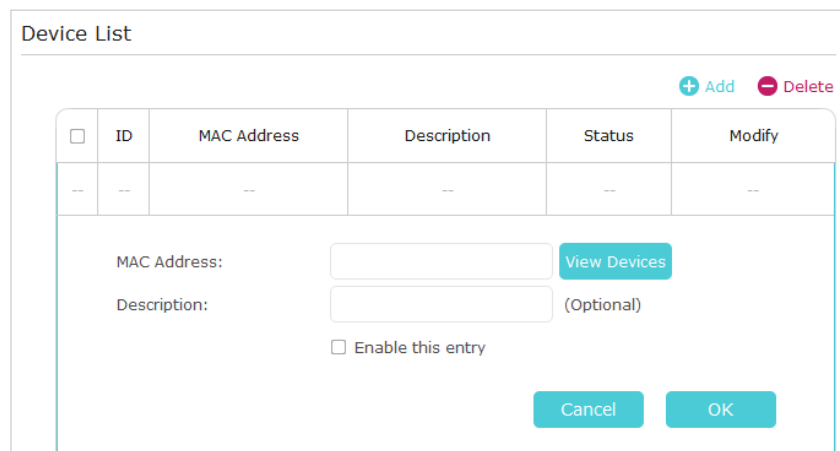

The screenshot shows the 'Device List' page. At the top right, there are '+ Add' and '- Delete' buttons. Below this is a table with columns: ID, MAC Address, Description, Status, and Modify. The table is currently empty. Below the table, there is a form for adding a new device. It includes fields for 'MAC Address' and 'Description' (Optional), a 'View Devices' button, and a checkbox for 'Enable this entry'. At the bottom right, there are 'Cancel' and 'OK' buttons.

| ID | MAC Address | Description | Status | Modify |
|----|-------------|-------------|--------|--------|
| -- | -- | -- | -- | -- |

6. Click [View Devices](#) to see how many devices are now connected to the network. Click [Choose](#) to choose a device. You can also enter the [MAC Address](#) manually.
7. Give a description of the entry in the [Description](#) field. (Optional)
8. Click [Enable this entry](#) to make this entry effective and click [OK](#) to save the settings.

Done!

Now MAC Filter is implemented to protect your wireless network.

3. 11. Administration

3. 11. 1. LAN IP Address

Follow the steps below to configure LAN settings of the extender.

1. Connect to the powerline extender wirelessly. Visit <http://tplinkplc.net>, and log in with the password you set for the extender.
2. Go to [Device Settings > LAN Settings](#).

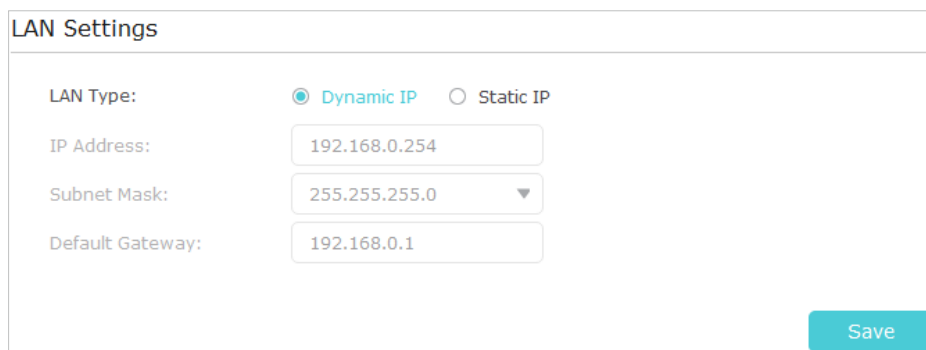

LAN Type: Select [Dynamic IP](#) to have your extender automatically obtain IP Address from the main router. Select [Static IP](#) to manually configure the LAN parameters.

IP Address: The IP address of the powerline extender.

Subnet Mask: The subnet mask associated with IP address.

Default Gateway: The IP address of the gateway device.

3. 11. 2. Set Up System Time

System time is the time displayed while the extender is running. The system time you configure here will be used for other time-based functions like Parental Controls, Wi-Fi Schedules. You can manually set how to get the system time.

1. Connect to the powerline extender wirelessly. Visit <http://tplinkplc.net>, and log in with the username and password you set for the extender.
2. Go to [System Tools > Time Settings](#) page.

- **To automatically synchronize the time:**

1. Select your local [Time Zone](#) from the drop-down menu.
2. In the [NTP Server I](#) field, enter the IP address or domain name of your desired NTP Server. (Optional)
3. In the [NTP Server II](#) field, enter the IP address or domain name of the second NTP Server. (Optional)
4. Click [Get GMT](#) and click [Save](#).

- **To manually set the date and time:**

1. In the [Time Settings](#) field, select your local [Time Zone](#).
2. Enter the current [Date](#).
3. Set the current [Time](#) (In 24-hour clock format, e.g. 16:00:00 is 04:00PM).
4. Click [Save](#).

- **To set up Daylight Saving time:**

1. Select [Enable Daylight Saving](#).
2. Select the correct [Start](#) date and time when daylight saving time starts at your local time zone.

3. Select the correct [End](#) date and time when daylight saving time ends at your local time zone.
4. Click [Save](#).

3. 11. 3. Upgrade the Firmware

TP-Link is dedicated to improving and enriching the product features, giving you a better network experience. We will release the latest firmware at TP-Link official website, you can download the latest firmware file from our website: www.tp-link.com and upgrade the firmware to the latest version.

1. Connect to the powerline extender wirelessly. Visit <http://tplinkplc.net>, and log in with the username and password you set for the extender.
2. Go to [System Tools](#) > [Firmware Upgrade](#) page and confirm the [Hardware Version](#).



Manual Upgrade

New Firmware File: [Browse](#)

Firmware Version: 3.0.0 Build 20191114 Rel.73290

Hardware Version: TL-WPA8631P v3.0

[Upgrade](#)

3. Go to www.tp-link.com. Download the latest firmware file for the extender.

■ **Note:** The upgraded firmware version must correspond to the hardware.

4. Click [Browse](#) to locate the downloaded new firmware file, and click [Upgrade](#).

5. Wait a few minutes for the upgrading and rebooting.

■ **Note:**

1. Before upgrading the firmware, it's better to back up your current settings.
2. During the upgrading process, do not turn off or reset the extender.

3. 11. 4. Backup and Restore Configuration Settings

The configuration settings are stored as a configuration file in the extender. You can back up the configuration file to your computer for future use and restore the extender to a previous settings from the backup file when needed. Moreover, if needed, you can erase the current settings and reset the extender to the default factory settings.

- **To back up configuration settings:**

1. Connect to the powerline extender wirelessly. Visit <http://tplinkplc.net>, and log in with the password you set for the extender.
2. Go to [System Tools](#) > [Backup & Restore](#) page.

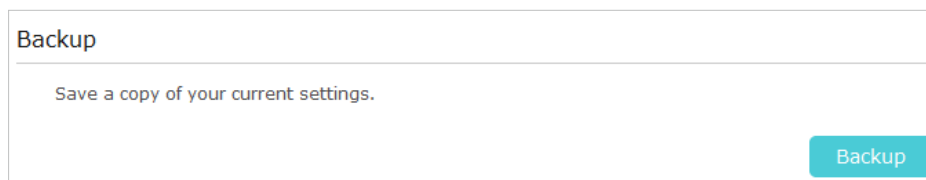

The screenshot shows a web interface titled "Backup". Below the title, there is a horizontal line and the text "Save a copy of your current settings." In the bottom right corner, there is a teal button labeled "Backup".

3. Click [Backup](#) to save a copy of the current settings to your local computer. A [config.bin](#) file will be stored to your computer.

- **To restore configuration settings:**

1. Connect to the powerline extender wirelessly. Visit <http://tplinkplc.net>, and log in with the password you set for the extender.
2. Go to [System Tools > Backup & Restore](#) page.

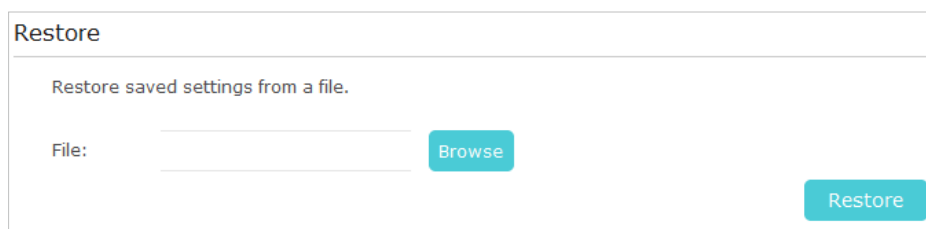

The screenshot shows a web interface titled "Restore". Below the title, there is a horizontal line and the text "Restore saved settings from a file." Below this text, there is a "File:" label followed by a text input field and a teal "Browse" button. In the bottom right corner, there is a teal button labeled "Restore".

3. Click [Browse](#) to locate the backup configuration file stored on your computer, and click [Restore](#). The configuration file is [config.bin](#).

4. Wait a few minutes for the restoring and rebooting.

■ **Note:** During the restoring process, do not turn off or reset the extender.

- **To reset the extender to factory default settings:**

1. Connect to the powerline extender wirelessly. Visit <http://tplinkplc.net>, and log in with the password you set for the extender.
2. Go to [System Tools > Backup & Restore](#) page.

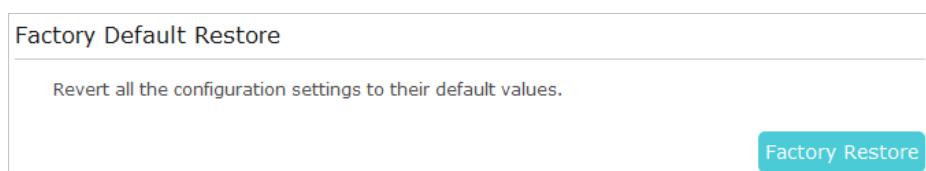

The screenshot shows a web interface titled "Factory Default Restore". Below the title, there is a horizontal line and the text "Revert all the configuration settings to their default values." In the bottom right corner, there is a teal button labeled "Factory Restore".

3. Click [Factory Restore](#) to reset the extender.

4. Wait a few minutes for the resetting and rebooting.

■ **Note:**

1. During the resetting process, do not turn off the extender.
2. We strongly recommend you back up the current configuration settings before resetting the extender.

3.11.5. System Log

When the extender does not work properly, you can save the system log and send it to the technical support for troubleshooting.

Follow the steps below to save the system log:

1. Connect to the powerline extender wirelessly. Visit <http://tplinkplc.net>, and log in with the password you set for the extender.
2. Go to [System Tools](#) > [System Log](#).

System Log

Log Filter: Type= and Level =

[Refresh](#) [Delete All](#)

| ID | Time | Type | Level | Log Content |
|----|-----------------|--------|-------|-------------------------------|
| 1 | 0 days 00:41:09 | OTHERS | INFO | User cleared up all the logs. |

[Save Log](#)

3. Choose the type and level of the system log according to your need.
4. Click [Save Log](#) to save the system log to local.

Chapter 4



OneMesh™ with Seamless Roaming

This chapter introduces the TP-Link OneMesh™ feature.

It contains the following sections:

- [What's a OneMesh™ Network](#)
- [How to Set Up a OneMesh™ Network](#)

4.1. What's a OneMesh™ Network

TP-Link OneMesh™  router and TP-Link OneMesh™  extenders work together to form one unified Wi-Fi network. Walk through your home and stay connected with the fastest possible speeds thanks to OneMesh's seamless coverage.

Unified Wi-Fi Network

Router and extenders share the same wireless settings, including network name, password and more.

Seamless Roaming

Devices automatically switch between your router and extenders as you move through your home for the fastest possible speeds.

Easy Setup and Management

Easily set up and manage a unified OneMesh™ network.

To check full list of TP-Link OneMesh™ devices, scan the QR code, or visit <https://www.tp-link.com/One-Mesh/compatibility>.



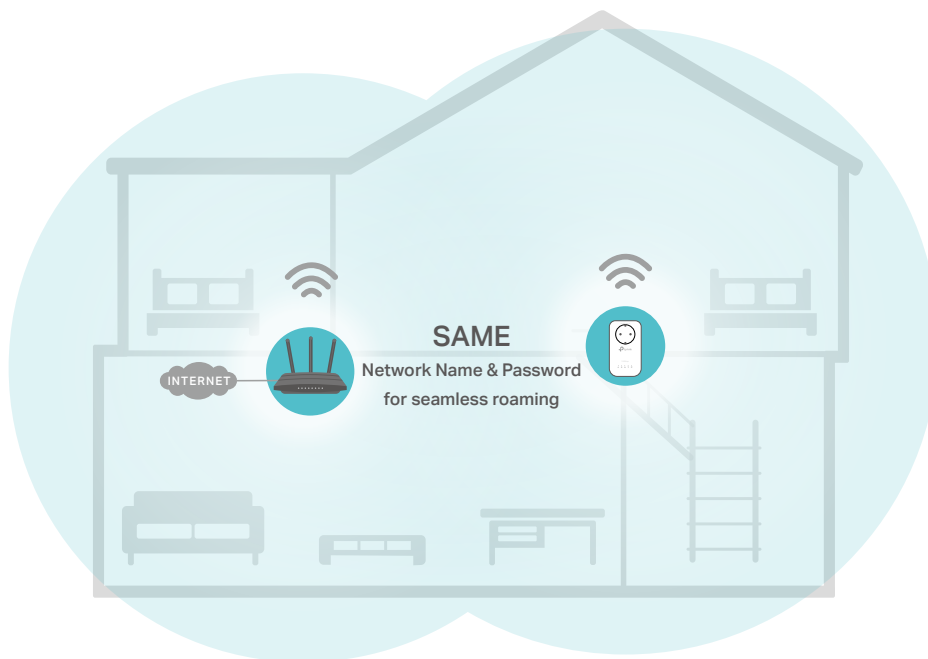

Unified OneMesh™ Network



4.2. How to Set Up a OneMesh™ Network

You can manage all mesh devices in the OneMesh™ network all on your router's web page.

Follow the steps below to create a OneMesh™ network.

1. Connect the extender to your computer wirelessly. Visit <http://tplinkplc.net>, and log in with the password you set for the extender.
2. Go to  OneMesh and toggle on **Join OneMesh**. When the extender's 2.4 GHz and 5 GHz Wi-Fi LEDs  turn solid on, Wi-Fi settings are copied.

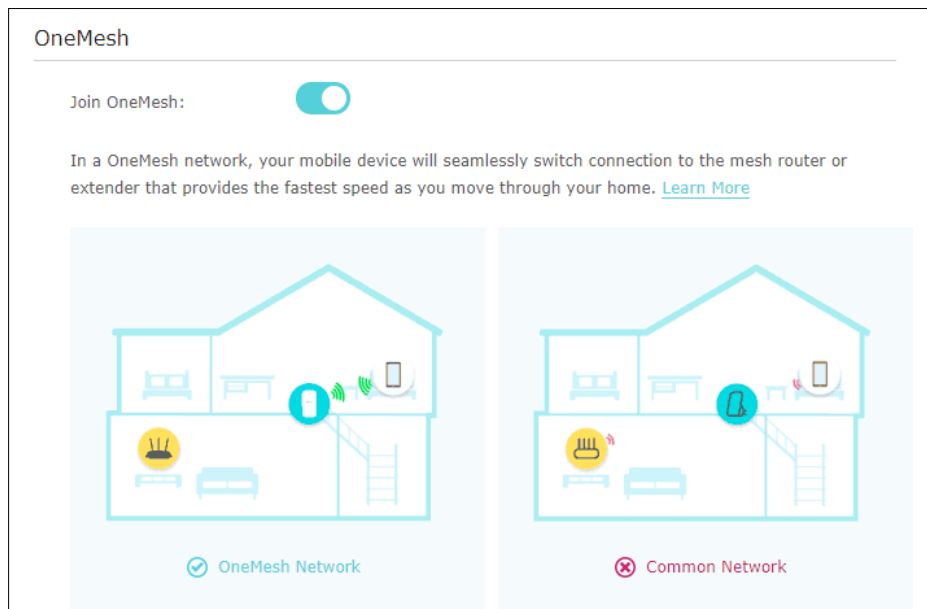

Note: This function is available only when your extender is connected to a OneMesh™ Router.

3. Enjoy the internet using your router's SSID and password.

COPYRIGHT & TRADEMARKS

Specifications are subject to change without notice.  tp-link is a registered trademark of TP-Link Technologies Co., Ltd. Other brands and product names are trademarks or registered trademarks of their respective holders.

No part of the specifications may be reproduced in any form or by any means or used to make any derivative such as translation, transformation, or adaptation without permission from TP-Link Technologies Co., Ltd. Copyright © 2020 TP-Link Technologies Co., Ltd. All rights reserved.

FCC compliance information statement



Product Name: AV1300 Gigabit Pass-through Powerline ac Wi-Fi Extender

Model Number: TL-WPA8631P

Responsible party:

TP-Link USA Corporation, d/b/a TP-Link North America, Inc.

Address: 145 South State College Blvd. Suite 400, Brea, CA 92821

Website: <https://www.tp-link.com/us/>

Tel: +1 626 333 0234

Fax: +1 909 527 6803

E-mail: sales.usa@tp-link.com

This equipment has been tested and found to comply with the limits for a Class B digital device, pursuant to part 15 of the FCC Rules. These limits are designed to provide reasonable protection against harmful interference in a residential installation. This equipment generates, uses and can radiate radio frequency energy and, if not installed and used in accordance with the instructions, may cause harmful interference to radio communications. However, there is no guarantee that interference will not occur in a particular installation. If this equipment does cause harmful interference to radio or television reception, which can be determined by turning the equipment off and on, the user is encouraged to try to correct the interference by one or more of the following measures:

- Reorient or relocate the receiving antenna.
- Increase the separation between the equipment and receiver.
- Connect the equipment into an outlet on a circuit different from that to which the receiver is connected.
- Consult the dealer or an experienced radio/ TV technician for help.

This device complies with part 15 of the FCC Rules. Operation is subject to the following two conditions:

1. This device may not cause harmful interference.
2. This device must accept any interference received, including interference that may cause undesired operation.

Any changes or modifications not expressly approved by the party responsible for compliance could void the user's authority to operate the equipment.

Note: The manufacturer is not responsible for any radio or TV interference caused by unauthorized modifications to this equipment. Such modifications could void the user's authority to operate the equipment.

FCC RF Radiation Exposure Statement

This equipment complies with FCC RF radiation exposure limits set forth for an uncontrolled environment. This device and its antenna must not be co-located or operating in conjunction with any other antenna or transmitter.

"To comply with FCC RF exposure compliance requirements, this grant is applicable to only Mobile Configurations. The antennas used for this transmitter must be installed to provide a separation distance of at least 20 cm from all persons and must not be co-located or operating in conjunction with any other antenna or transmitter."

We, **TP-Link USA Corporation**, has determined that the equipment shown as above has been shown to comply with the applicable technical standards, FCC part 15. There is no unauthorized change is made in the equipment and the equipment is properly maintained and operated.

Issue Date: 2020.04.20



Product Name: AV1300 Gigabit Pass-through Powerline Adapter

Model Number: TL-PA8010P

Responsible party:

TP-Link USA Corporation, d/b/a TP-Link North America, Inc.

Address: 145 South State College Blvd. Suite 400, Brea, CA 92821

Website: <https://www.tp-link.com/us/>

Tel: +1 626 333 0234

Fax: +1 909 527 6803

E-mail: sales.usa@tp-link.com

This equipment has been tested and found to comply with the limits for a Class B digital device, pursuant to part 15 of the FCC Rules. These limits are designed to provide reasonable protection against harmful interference in a residential installation. This equipment generates, uses and can radiate radio frequency energy and, if not installed and used in accordance with the instructions, may cause harmful interference to radio communications. However, there is no guarantee that interference will not occur in a particular installation. If this equipment does cause harmful interference to radio or television reception, which can be determined by turning the equipment off and on, the user is encouraged to try to correct the interference by one or more of the following measures:

- Reorient or relocate the receiving antenna.
- Increase the separation between the equipment and receiver.
- Connect the equipment into an outlet on a circuit different from that to which the receiver is connected.
- Consult the dealer or an experienced radio/ TV technician for help.

This device complies with part 15 of the FCC Rules. Operation is subject to the following two conditions:

1. This device may not cause harmful interference.
2. This device must accept any interference received, including interference that may cause undesired operation.

Any changes or modifications not expressly approved by the party responsible for compliance could void the user's authority to operate the equipment.

We, **TP-Link USA Corporation**, has determined that the equipment shown as above has been shown to comply with the applicable technical standards, FCC part 15. There is no unauthorized change is made in the equipment and the equipment is properly maintained and operated.

Issue Date: 2020.04.20

CE Mark Warning



This is a class B product. In a domestic environment, this product may cause radio interference, in which case the user may be required to take adequate measures.

OPERATING FREQUENCY(the maximum transmitted power)

2400 MHz -2483.5 MHz (20dBm)

5150 MHz -5250 MHz (23dBm)

EU Declaration of Conformity

TP-Link hereby declares that the device is in compliance with the essential requirements and other relevant provisions of directives 2014/53/EU, 2009/125/EC, 2011/65/EU and (EU)2015/863.

The original EU declaration of conformity may be found at <https://www.tp-link.com/en/ce>

RF Exposure Information

This device meets the EU requirements (2014/53/EU Article 3.1a) on the limitation of exposure of the general public to electromagnetic fields by way of health protection.

The device complies with RF specifications when the device used at 20 cm from your body.

National restrictions

Attention: This device may only be used indoors in all EU member states and EFTA countries.

| | | | | | | | | |
|--|----|----|----|----|----|----|----|----|
| | AT | BE | BG | CH | CY | CZ | DE | DK |
| | EE | EL | ES | FI | FR | HR | HU | IE |
| | IS | IT | LI | LT | LU | LV | MT | NL |
| | NO | PL | PT | RO | SE | SI | SK | UK |

Canadian Compliance Statement

This device contains licence-exempt transmitter(s)/receiver(s) that comply with Innovation, Science and Economic Development Canada's licence-exempt RSS(s). Operation is subject to the following two conditions:

- (1) This device may not cause interference.
- (2) This device must accept any interference, including interference that may cause undesired operation of the device.

L'émetteur/récepteur exempt de licence contenu dans le présent appareil est conforme aux CNR d'Innovation, Sciences et Développement économique Canada applicables

aux appareils radio exempts de licence. L'exploitation est autorisée aux deux conditions suivantes :

- 1) L'appareil ne doit pas produire de brouillage;
- 2) L'appareil doit accepter tout brouillage radioélectrique subi, même si le brouillage est susceptible d'en compromettre le fonctionnement.

Caution:

The device for operation in the band 5150–5250 MHz is only for indoor use to reduce the potential for harmful interference to co-channel mobile satellite systems;

DFS (Dynamic Frequency Selection) products that operate in the bands 5250- 5350 MHz, 5470-5600MHz, and 5650-5725MHz.

Avertissement:

Le dispositif fonctionnant dans la bande 5150-5250 MHz est réservé uniquement pour une utilisation à l'intérieur afin de réduire les risques de brouillage préjudiciable aux systèmes de satellites mobiles utilisant les mêmes canaux

Les produits utilisant la technique d'atténuation DFS (sélection dynamique des fréquences) sur les bandes 5250- 5350 MHz, 5470-5600MHz et 5650-5725MHz.

Radiation Exposure Statement

This equipment complies with IC radiation exposure limits set forth for an uncontrolled environment. This equipment should be installed and operated with minimum distance 20cm between the radiator & your body.

Déclaration d'exposition aux radiations

Cet équipement est conforme aux limites d'exposition aux rayonnements IC établies pour un environnement non contrôlé. Cet équipement doit être installé et utilisé avec un minimum de 20 cm de distance entre la source de rayonnement et votre corps.

Industry Canada Statement

CAN ICES-3 (B)/NMB-3(B)

CAN ICES-6/NMB-6

Korea Warning Statements

당해 무선설비는 운용중 전파혼신 가능성이 있음.

NCC Notice

注意!

依據 低功率電波輻射性電機管理辦法

第十二條 經型式認證合格之低功率射頻電機，非經許可，公司、商號或使用者均不得擅自變更頻率、加大功率或變更原設計之特性或功能。

第十四條 低功率射頻電機之使用不得影響飛航安全及干擾合法通信；經發現有干擾現象時，應立即停用，並改善至無干擾時方得繼續使用。前項合法通信，指依電信規定作業之無線電信。低功率射頻電機需忍受合法通信或工業、科學以及醫療用電波輻射性電機設備之干擾。

4.7.9.1 應避免影響附近雷達系統之操作。

4.7.9.2 高增益指向性天線只得應用於固定式點對點系統。

BSMI Notice

安全諮詢及注意事項

- 請使用原裝電源供應器或只能按照本產品注明的電源類型使用本產品。
- 清潔本產品之前請先拔掉電源線。請勿使用液體、噴霧清潔劑或濕布進行清潔。
- 注意防潮，請勿將水或其他液體潑灑到本產品上。
- 插槽與開口供通風使用，以確保本產品的操作可靠並防止過熱，請勿堵塞或覆蓋開口。
- 請勿將本產品置放於靠近熱源的地方。除非有正常的通風，否則不可放在密閉位置中。
- 請不要私自拆開機殼或自行維修，如產品有故障請與原廠或代理商聯繫。

| | | | | | | |
|--|--|---|----------------------|---|--|--|
| 設備名稱： Equipment name AV1300 Gigabit Pass-through Powerline ac Wi-Fi Extender | | 型號（型式）： Type designation (Type) TL-WPA8631P/TL-WPA8635P | | | | |
| 單元 Unit | 限用物質及其化學符號 Restricted substances and its chemical symbols | | | | | |
| | 鉛 Lead (Pb) | 汞 Mercury (Hg) | 鎘 Cadmium (Cd) | 六價鉻 Hexavalent chromium (Cr+6) | 多溴聯苯 Polybrominated biphenyls (PBB) | 多溴二苯醚 Polybrominated diphenyl ethers (PBDE) |
| PCB | ○ | ○ | ○ | ○ | ○ | ○ |
| 外殼 | ○ | ○ | ○ | ○ | ○ | ○ |
| 電源供應板 | — | ○ | ○ | ○ | ○ | ○ |
| 其他及其配件 | — | ○ | ○ | ○ | ○ | ○ |
| 備考 1. “超出 0.1 wt %” 及 “超出 0.01 wt %” 係指限用物質之百分比含量超出百分比含量基準值 Note 1: “Exceeding 0.1 wt %” and “exceeding 0.01 wt %” indicate that the percentage content of the restricted substance exceeds the reference percentage value of presence condition. | | | | | | |
| 備考 2. “○” 係指該項限用物質之百分比含量未超出百分比含量基準值。 Note 2: “○” indicates that the percentage content of the restricted substance does not exceed the percentage of reference value of presence. | | | | | | |
| 備考 3. “—” 係指該項限用物質為排除項目。 Note 3: The “—” indicates that the restricted substance corresponds to the exemption. | | | | | | |



Продукт сертифіковано згідно с правилами системи УкрСЕПРО на відповідність вимогам нормативних документів та вимогам, що передбачені чинними законодавчими актами України.





Safety Information



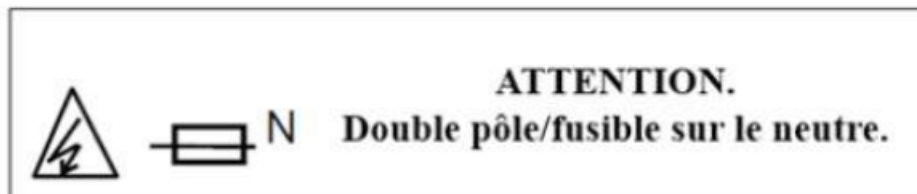
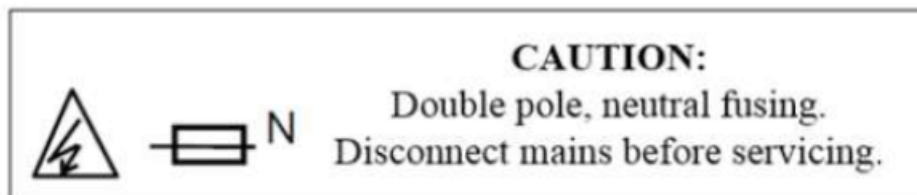

- Keep the device away from water, fire, humidity or hot environments.
- Do not attempt to disassemble, repair, or modify the device. If you need service, please contact us.
- Do not use the device where wireless devices are not allowed.
- The socket-outlet shall be installed near the equipment and shall be easily accessible.
-  For passthrough devices, plug the power strips into the integrated electrical sockets of the devices, but devices of the same or another type not be stacked in normal use.
- Plug the powerline devices directly into the wall outlets but not the power strips.
- Plug the product into the wall outlets with earthing connection through the plug.

Please read and follow the above safety information when operating the device. We cannot guarantee that no accidents or damage will occur due to improper use of the device. Please use this product with care and operate at your own risk.



Explanation of the symbols on the product label

| Symbol | Explanation |
|---|-----------------|
|  | AC voltage |
|  | Indoor use only |

| | |
|---|---|
|  | Protection earth |
|  | Warning electric shock |
|  | Fuse is used in neutral N |
|  | <p>RECYCLING</p> <p>This product bears the selective sorting symbol for Waste electrical and electronic equipment (WEEE). This means that this product must be handled pursuant to European directive 2012/19/EU in order to be recycled or dismantled to minimize its impact on the environment.</p> <p>User has the choice to give his product to a competent recycling organization or to the retailer when he buys a new electrical or electronic equipment.</p> |