



Installation Guide

Network Video Recorder

Contents

Chapter 1 Appearance	1
1.1 Front Panel.....	1
1.2 Rear Panel.....	1
Chapter 2 Installation	3
2.1 Package Contents	3
2.2 Safety Precautions	3
2.3 Installation Tools.....	6
2.4 Hard Drive Installation	6
2.5 Product Installation	9
Chapter 3 Hardware Connection	11
Chapter 4 Configuration	12
Appendix FAQ	15

Chapter 1 Appearance

1.1 Front Panel

The figure is for demonstration purposes only. Your device may differ in appearance from the depicted.



LED	Indication
LAN	<p>On: Network is working properly.</p> <p>Flashing: Data is being transmitted or received.</p> <p>Off: Network is malfunctioning.</p>
HDD	<p>On: The HDD is normal.</p> <p>Off: No HDD or the HDD is malfunctioning.</p>
POWER	<p>On: System is running normally.</p> <p>Off: System is running abnormally.</p>

USB Port

2 USB ports for additional devices such as USB mouse, USB storage device, and USB keyboard.

1.2 Rear Panel

The figure is for demonstration purposes only. Your device may differ in appearance from the depicted.

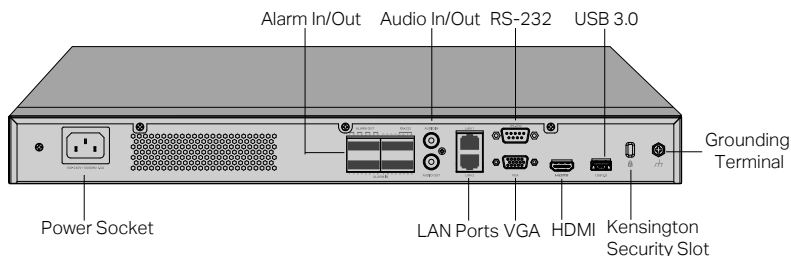

Power Socket

Connect the female connector of the power cord here, and the male connector to the AC power outlet. Make sure that the voltage of the power supply meets the requirement of the input voltage (100–240 V~ 50/60 Hz).

Alarm Input/Output

Connect to alarm input/output devices using the provided terminal blocks.

Audio Input/Output

Connector for audio input and output.

LAN Ports

Connect to an Ethernet device (eg. router and switch).

VGA

Output port for analog video signals. Connect your monitor to this port if it uses VGA connection.

HDMI

Output port for high-definition audio and video signals. Connect your monitor to this port if it uses HDMI connection.

USB 3.0

Connect to additional devices such as USB mouse, USB storage device, and USB keyboard.

Kensington Security Slot

Secure the lock (not provided) into the security slot to prevent the device from being stolen.

Grounding Terminal

The NVR already comes with lightning protection mechanism. You can also ground the NVR through the PE (Protecting Earth) cable of AC cord or with Ground Cable. For detailed lightning protection measures, go to <https://www.tp-link.com/support>, search the model number of your NVR and go to the product Support web page, refer to the **Lightning Protection Guide** from the Related Documents:

https://www.tp-link.com/us/configuration-guides/lightning_protection_guide/.



Caution:

Please use the provided power cord.

Chapter 2 Installation

2.1 Package Contents

Make sure that the package contains the following items. Please contact your distributor, if any of the listed items is damaged or missing. The figures are for demonstration only. The actual items may differ in appearance and quantity from the depicted.

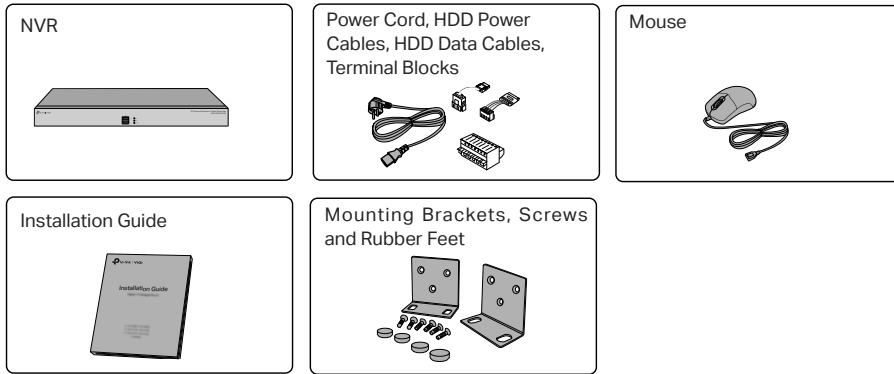

2.2 Safety Precautions

To avoid any device damage and bodily injury caused by improper use, you should observe the following rules.

- **Safety Precautions**
- Keep the power off during the installation.
- Wear an ESD-preventive wrist strap, and make sure that the wrist strap has a good skin contact and is well grounded.
- Use only the power cord provided with the device.
- Make sure that the supply voltage matches the specifications indicated on the rear panel of the device.
- Ensure that the device is installed in a well-ventilated environment and its ventilation hole is not blocked.
- Do not open or remove the cover of the device.
- Before cleaning the device, cut off the power supply. Do not clean it by the waterish cloth, and never use any other liquid cleaning method.

- Place the device with its bottom surface downward.

▪ **Site Requirements**

Temperature/Humidity

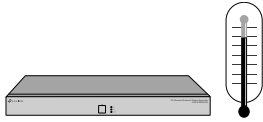

Keep the equipment room at an appropriate level of temperature and humidity. Too much or too little humidity may lead to bad insulation, leakage of electricity, mechanical property changes, and corrosion. High temperatures may accelerate aging of the insulation materials, significantly shortening the service life of the device.

Clearness

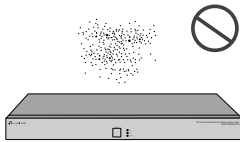

The dust accumulated on the device can be absorbed by static electricity and result in poor contact of metal contact points. Some measures have been taken for the device to prevent static electricity, but too strong static electricity can cause deadly damage to the electronic elements on the internal circuit board. To avoid the effect of static electricity on the operation of the device, attach much importance to the following items:

- Dust the device regularly, and keep the indoor air clean.
- Keep the device well grounded and ensure that the static electricity has been transferred.

Electromagnetic Interference

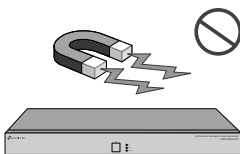

Electronic elements including capacitance and inductance on the device can be affected by external interferences, such as conducted emission

by capacitance coupling, inductance coupling, and impedance coupling. To decrease the interferences, make sure to take the following measures:

- Use the power supply that can effectively filter interference from the power grid.
- Keep the device far from high-frequency and strong-current devices such as radio transmitting station.
- Use electromagnetic shielding when necessary.

Lightning Protection

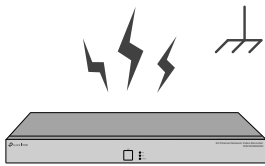

Extremely high voltage currents can be produced instantly when lightning occurs and the air in the electric discharge path can be instantly heated up to 20,000 °C. As this instant current is strong enough to damage electronic devices, more effective lightning protection measures should be taken.

- Ensure that the rack and the device are well earthed.
- Make sure the power socket has a good contact with the ground.
- Keep a reasonable cabling system and avoid induced lightning.
- Use the signal SPD (Surge Protective Device) when wiring outdoor.



Note:

For detailed lightning protection measures, go to <https://www.tp-link.com/support>, search the model number of your product and go to the product Support web page, refer to the **Lightning Protection Guide** from the Related Documents: https://www.tp-link.com/us/configuration-guides/lightning_protection_guide/.

Installation Site

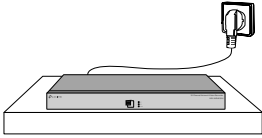

When installing the device on a rack or a flat workbench, attach much importance to the following items:

- The rack or workbench is flat, stable, and sturdy enough to support the weight of 5.5 kg at least.
- The rack or workbench has a good ventilation system. The equipment room is well ventilated.
- The rack is well grounded. Keep the device less than 1.5 meters away from the power socket.

2.3 Installation Tools

- Phillips screwdriver
- ESD-preventive wrist wrap
- Cables



Note:

These tools are not included with our product. If needed, you can purchase them separately.

2.4 Hard Drive Installation

When installing for the first time, please prepare a 3.5-inch hard disk drive (HDD). It is recommended to use the HDD of surveillance or enterprise level. Before installation, please disconnect the power from the network video recorder (NVR).

1. Remove the fixing screws on the side and back panels to open the cover of the NVR.

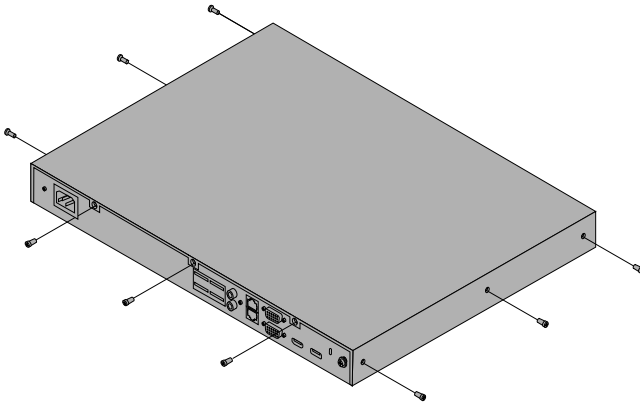

2. Remove the fixing screws to detach the HDD bracket.

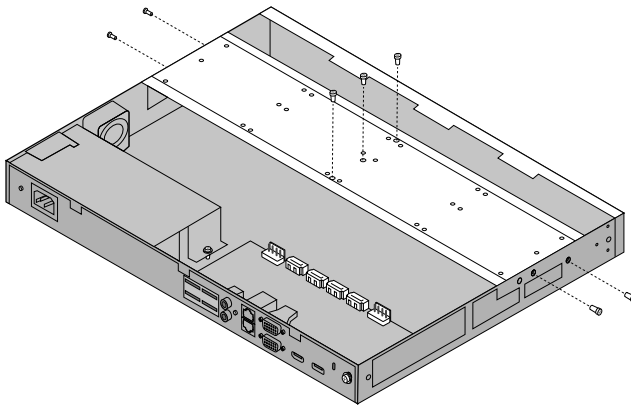

3. Match the screws on the HDD with the holes on the NVR. Up to 4 HDDs can be mounted at a time.

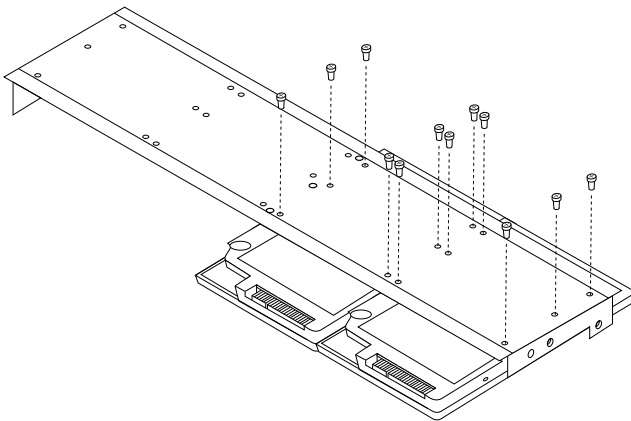

4. Install the HDD bracket back to the NVR.

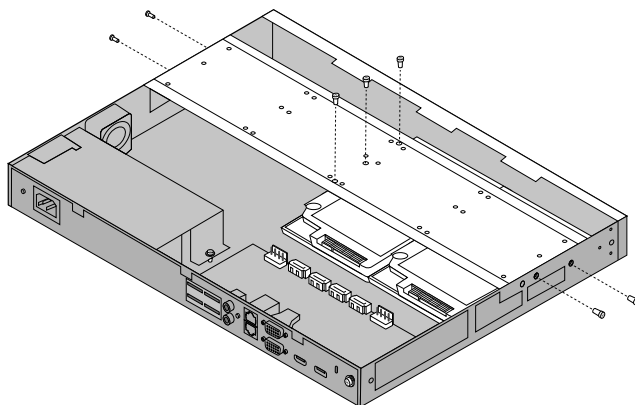

5. Connect the power cables and data cables.

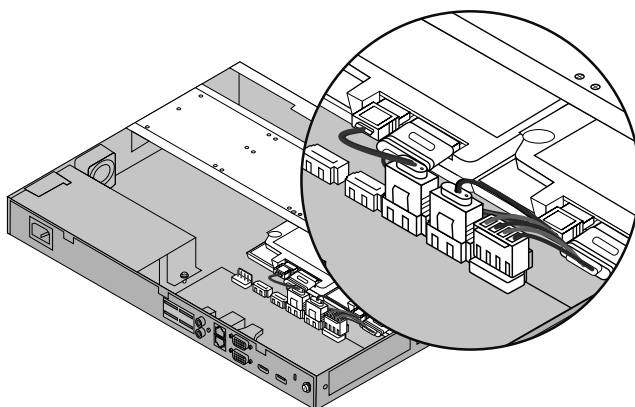

6. Replace the cover and fasten the screws of the NVR.

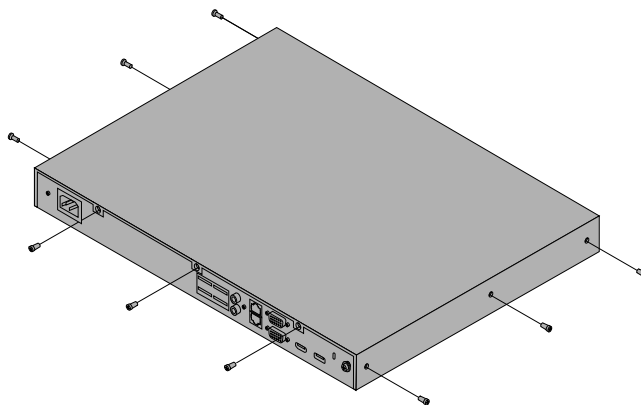

2.5 Product Installation

▪ Desktop Installation

To install the device on the desktop, follow the steps:

1. Set the device on a flat surface which is strong enough to support the entire weight of the device with all fittings.
2. Remove the adhesive backing papers from the rubber feet.
3. Turnover the device and attach the supplied rubber feet to the recessed areas on the bottom at each corner of the device.

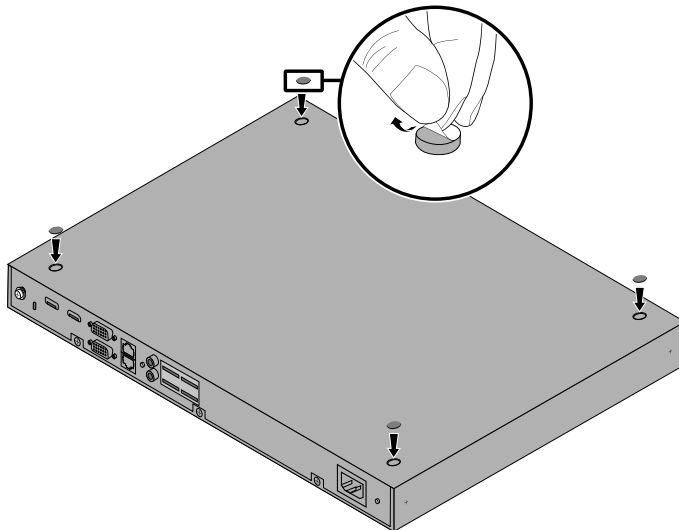

▪ Rack Installation

To install the device in an EIA standard-sized, 19-inch rack, follow the instructions described below:

1. Check the efficiency of the grounding system and the stability of the rack.
2. Secure the supplied rack-mounting brackets to each side of the device with supplied screws, as illustrated in the following figure.

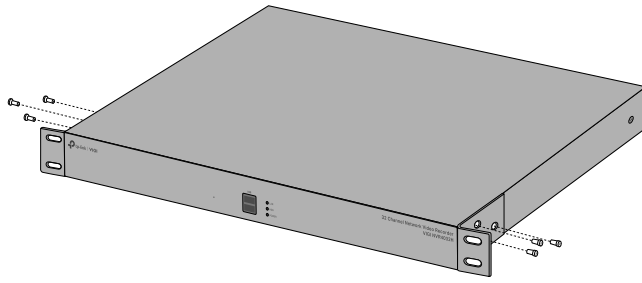

3. After the brackets are attached to the device, use suitable screws (not provided) to secure the brackets to the rack, as illustrated in the following figure.

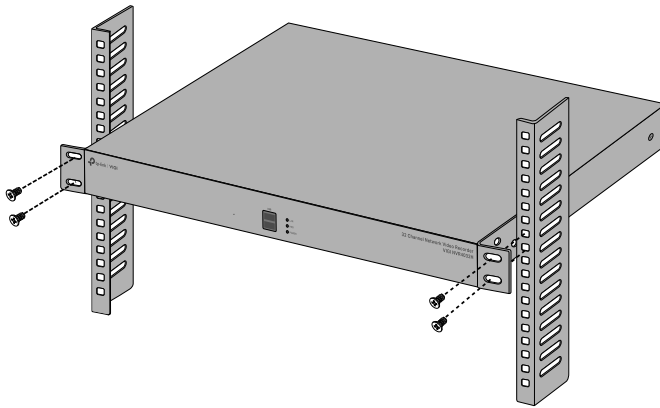

Chapter 3 Hardware Connection

Follow the steps below to complete the hardware connection.

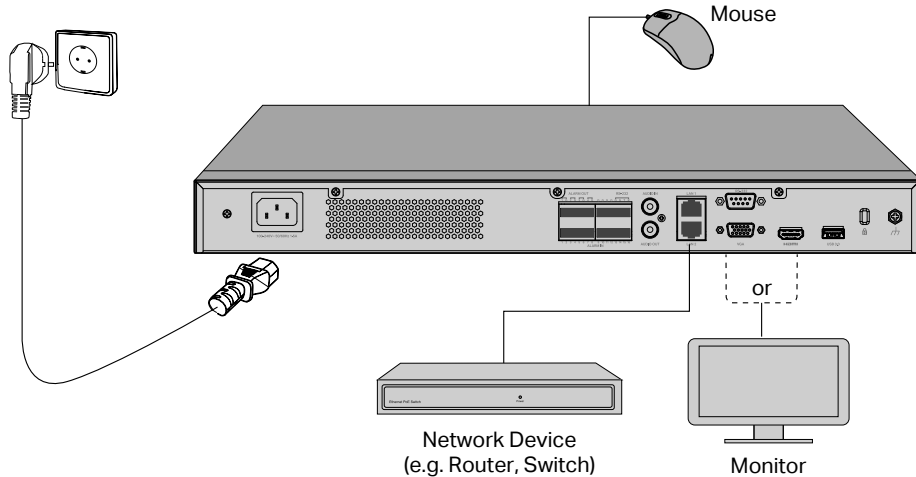

1. Connect your monitor to the HDMI or VGA port according to the connection port it supports.
2. Connect your monitor to a power source and turn it on.
3. Connect the LAN port of the NVR to a network device with an Ethernet cable.
4. Connect the provided USB Mouse to the USB Interface of the NVR.



Note:

- If you want to turn off the NVR after installing the hard drive, right click on the Live View screen and click the Power button on Main Menu of your monitor. Do not unplug it directly.
 - The input voltage should match the power requirements of the NVR.
 - The buzzer on the NVR may be triggered when no hard drive is installed or the hard drive in the NVR hasn't been initialized. You can turn it off in Event-Exception Detection-Disk Exception.
-

Chapter 4 Configuration

NVR can add and manage cameras in batches.

* Here we use TP-Link cameras as an example. For other camera brands, please refer to their User Manuals to add the cameras.

Step 1. Connect your cameras to the same network as your NVR.

Step 2. Follow the instructions to finish Quick Setup.

1. Create a login password for the NVR and a preset password for your unset cameras.

Note: Enter an email address for resetting the password of NVR or cameras.

2. Click Auto Initialize and the NVR will automatically find and add the cameras in your network.

Note: If you don't want to use Auto Initialize, click Manually Initialize and follow the Setup Wizard to add cameras in your network and complete the setup.

Step 3. Right click on the Live View screen to open the Main Menu for management.

(Optional) Step 4. Bind your NVR to a TP-Link ID for remote access and management.

1. Right click on the Live View screen and click Settings.
2. Click Cloud Services on the top, enter your TP-Link ID and password, and click Bind.



Note:

Make sure your NVR can get access to the internet before binding.

- If you don't have a TP-Link ID, sign up first.
 - If your NVR fails to connect to the internet, please refer to FAQ-Q3.
 - For more instructions, please refer to the NVR's User Guide.
-

If you want to add a camera after Quick Setup, please follow the steps below:

1. Right click on the Live View screen and click Add Camera.
2. Select a camera and click + to add your camera directly. If you have disabled Plug and Play on your NVR, please create a password or use the preset password for your unset camera.



Note:

- The password preset for cameras in Quick Setup will be applied to your unset cameras.
 - If your cameras have been activated, use the previous passwords to add and manage the cameras.
 - If you can't find your camera, refer to FAQ-Q2.
-

More Management Methods

You can add and manage your devices via any of the methods below.

▪ Method 1: Via the TP-Link VIGI App

Remotely view live video, manage NVR, and get instant alerts.

1. Download and install the latest TP-Link VIGI app.



or



2. Open the app and log in with your TP-Link ID. If you don't have an account, sign up first.
3. Tap the + button on the top right and follow the app instructions to add your NVR.

▪ Method 2: Via a Web Browser

View live video and modify NVR settings via a web browser.

1. Find the NVR's IP address on your router's client page.
2. On your local computer, open a web browser and enter https://NVR's IP address (https://192.168.0.240 by default).
3. Select your Country/Region and Time Zone.

4. Set a password to activate the NVR.

Done. You can manage and change NVR settings, and add cameras on the web management page.

▪ **Method 3: Via the VIGI Security Manager (Windows only)**

View live video and modify NVR settings on your computer.

1. Download the VIGI Security Manager on your computer at <https://www.tp-link.com/support/download/vigi-security-manager/>.
2. Install the VIGI Security Manager and open it.
3. NVR on the same network as your computer can be automatically discovered. Go to Settings > Discovered Devices, click Add, and follow the instructions to add your NVR.

Appendix FAQ

Q1. What should I do if I forget the login password of my NVR?

1. Click Forgot Password on the login page and then follow the instructions to reset the password.
2. Remove the cover, then press and hold the Reset button inside the NVR for over 3 seconds. The NVR will restore to the factory settings. Then follow Quick Setup to create a login password.

Q2. What can I do if no cameras are found?

1. Refresh to discover your cameras again.
2. Make sure the cameras are powered on.
3. Make sure your cameras and NVR or computer are in the same network.
4. Try to add your cameras manually.

Q3. What can I do if my NVR fails to connect to the Internet??

1. Check if the internet is working properly.
2. Make sure your NVR is in the same network segment as your network devices, or select Auto as the mode to configure the NVR to obtain a dynamic IP address. For more details, please refer to the NVR's User Guide.

If you have more questions, please visit <https://www.tp-link.com/support/faq/2850/>.

Safety Information

This device is restricted to indoor use only.

- Keep the device away from water, fire, humidity or hot environments.
- Do not attempt to disassemble, repair, or modify the device.
- Do not use damaged charger or USB cable to charge the device.
- Do not use any other chargers than those recommended.
- Adapter shall be installed near the equipment and shall be easily accessible.
- Use only power supplies which are provided by manufacturer and in the original packing of this product. If you have any questions, please don't hesitate to contact us.
- Avoid disposal of a battery into fire or a hot oven, or mechanically crushing or cutting of a battery, that can result in an explosion.
- Place the device with its bottom surface downward. Install it at stable places, and prevent it from falling.
- The power adapter must be used indoors. Make sure that the temperature of the power adapter is within 0-40°C.

This equipment is not suitable for use in locations where children are likely to be present.

CAUTION!

Risk of explosion if the battery is replaced by an incorrect type.

*Some devices may be incompatible, such as wireless mouse.

Please read and follow the above safety information when operating the device. We cannot guarantee that no accidents or damage will occur due to improper use of the device. Please use this product with care and operate at your own risk.

CAUTION!

Avoid replacement of a battery with an incorrect type that can defeat a safeguard.

Avoid disposal of a battery into fire or a hot oven, or mechanically crushing or cutting of a battery, that can result in an explosion.

Do not leave a battery in an extremely high temperature surrounding environment that can result in an explosion or the leakage of flammable liquid or gas;

Do not leave a battery subjected to extremely low air pressure that may result in an explosion or the leakage of flammable liquid or gas.

CE Mark Warning



This is a class A product. In a domestic environment, this product may cause radio interference, in which case the user may be required to take adequate measures.

EU Declaration of Conformity

TP-Link hereby declares that the device is in compliance with the essential requirements and other relevant provisions of directives 2014/30/EU, 2014/35/EU, 2009/125/EC, 2011/65/EU and (EU)2015/863.

The original EU Declaration of Conformity may be found at <https://www.tp-link.com/en/support/ce/>



UK Declaration of Conformity

TP-Link hereby declares that the device is in compliance with the essential requirements and other relevant provisions of the Electromagnetic Compatibility Regulations 2016 and Electrical Equipment (Safety) Regulations 2016.

The original UK Declaration of Conformity may be found at <https://www.tp-link.com/support/ukca/>



Продукт сертифіковано згідно с правилами системи УкрСЕПРО на відповідність вимогам нормативних документів та вимогам, що передбачені чинними законодавчими актами України.

Korea Warning Statements

당해 무선설비는 운용중 전파혼신 가능성이 있음.

この装置は、クラスA情報技術装置です。この装置を家庭環境で使用すると電波妨害を引き起こすことがあります。この場合には使用者が適切な対策を講ずるよう要求されることがあります。 VCCI-A

BSMI Notice

安全諮詢及注意事項

- 請使用原裝電源供應器或只能按照本產品注明的電源類型使用本產品。
- 清潔本產品之前請先拔掉電源線。請勿使用液體、噴霧清潔劑或濕布進行清潔。
- 注意防潮，請勿將水或其他液體潑灑到本產品上。
- 插槽與開口供通風使用，以確保本產品的操作可靠並防止過熱，請勿堵塞或覆蓋開口。
- 請勿將本產品置放於靠近熱源的地方。除非有正常的通風，否則不可放在密閉位置中。
- 不要私自拆開機殼或自行維修，如產品有故障請與原廠或代理商聯繫。
- 警告：為避免電磁干擾，本產品不應安裝或使用於住宅環境。

限用物質含有情況標示聲明書

設備名稱: 32 Channel Network Video Recorder

型號 (型式): VIGI NVR4032H

單元	限用物質及其化學符號					
	鉛 (Pb)	汞 (Hg)	鎘 (Cd)	六價鉻 (Cr ⁺⁶)	多溴聯苯 (PBB)	多溴二苯醚 (PBDE)
PCB	○	○	○	○	○	○
外殼	○	○	○	○	○	○
電源供應器	—	○	○	○	○	○
其他及其配件	—	○	○	○	○	○

備考 1. “超出 0.1 wt %” 及 “超出 0.01 wt %” 係指限用物質之百分比含量超出百分比含量基準值

Note 1: “Exceeding 0.1 wt %” and “exceeding 0.01 wt %” indicate that the percentage content of the restricted substance exceeds the reference percentage value of presence condition.

備考 2. “○” 係指該項限用物質之百分比含量未超出百分比含量基準值。

Note 2: “○” indicates that the percentage content of the restricted substance does not exceed the percentage of reference value of presence.

備考 3. “—” 係指該項限用物質為排除項目。

Note 3: The “—” indicates that the restricted substance corresponds to the exemption.

HDMI®

The terms HDMI, HDMI High-Definition Multimedia Interface, and the HDMI Logo are trademarks or registered trademarks of HDMI Licensing Administrator, Inc.



To ask questions, find answers, and communicate with TP-Link users or engineers, please visit <https://community.tp-link.com> to join TP-Link Community.



For technical support, the user guide and other information, please visit <https://www.tp-link.com/support>, or simply scan the QR code.

