

Quick Start Guide

Tapo Solar Panel

*Images may differ from actual products.

7106510839 REV1.0.0 ©2024 TP-Link

02 / Mounting

Scenario 1. Mount Solar Panel Only

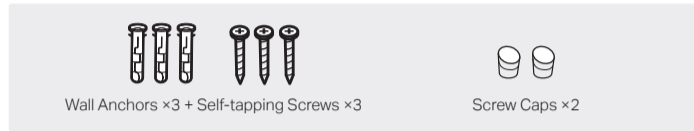

1. Drill Holes

Stick the mounting template to a solid and level wall surface. Drill three screw holes according to the template.

Φ=6 mm (15/64 in.)

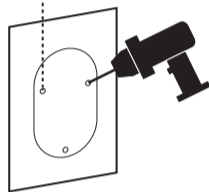

2. Mount Bracket

Insert three wall anchors into the holes and use the mounting screws to affix the solar panel bracket over the anchors.

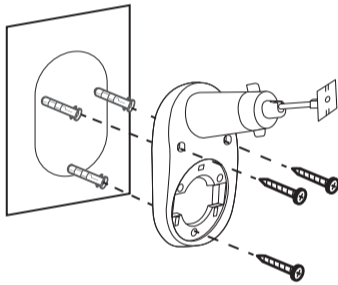

3. Install Solar Panel

Slide the solar panel onto the mounting bracket until it clicks into place.

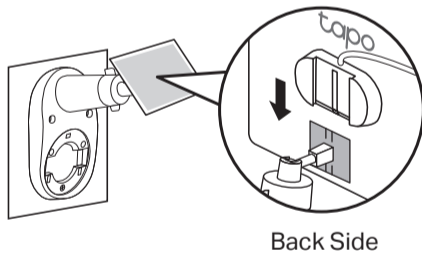

Back Side

4. Adjust Angle

Loosen the adjustable screw, tilt the solar panel to adjust the angle, and then tighten the adjustable screw.

The recommended tilt angle between the panel and the horizontal ground is 35° ~ 45°.

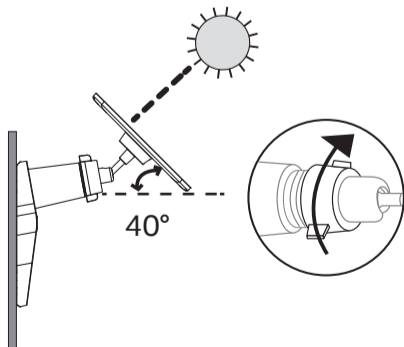

40°

5. Install Screw Caps & Base Cover

Insert two screw caps into the screw holes until flush, then install the base cover.

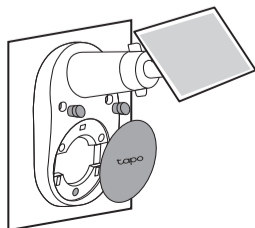

01 / Position the Solar Panel

The solar panel captures free, clean solar energy and provides non-stop power supply for your Tapo cameras. The position and tilt angle of the solar panel greatly affects the solar efficiency.

1. Choose a location where the solar panel gets the most sunlight throughout the year.
2. Position the panel south-facing in the Northern Hemisphere or north-facing in the Southern Hemisphere. The recommended tilt angle between the panel and the horizontal ground is 35° ~ 45°.
3. Regularly wipe the panel to remove dust and debris.

Scenario 2. Mount Solar Panel & Extra Camera

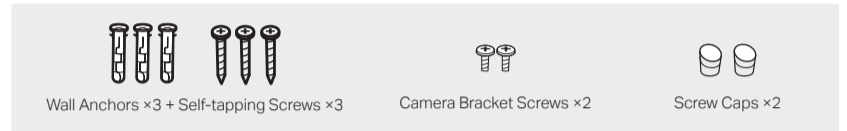

1. Drill Holes

Stick the mounting template to a solid and level wall surface. Drill three screw holes according to the template.

Φ=6 mm (15/64 in.)

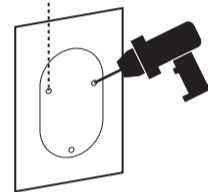

2. Install Camera Bracket

Secure the camera bracket to the solar panel bracket using two screws. The third hole below is for securing the solar panel bracket.

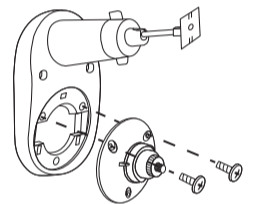

3. Mount Solar Panel Bracket

Insert three wall anchors into the holes and use the mounting screws to affix the solar panel bracket over the anchors. Then, insert two screw caps into the upper screw holes until flush.

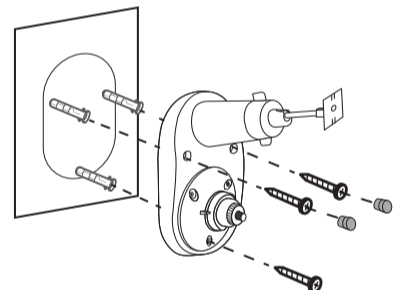

4. Install Solar Panel

Slide the solar panel onto the mounting bracket until it clicks into place.

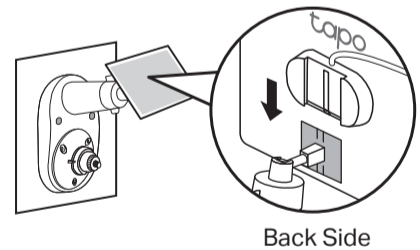

Back Side

5. Adjust Solar Panel Angle

Loosen the adjustable screw, tilt the solar panel to adjust the angle, and then tighten the adjustable screw.

The recommended tilt angle between the panel and the horizontal ground is 35° ~ 45°.

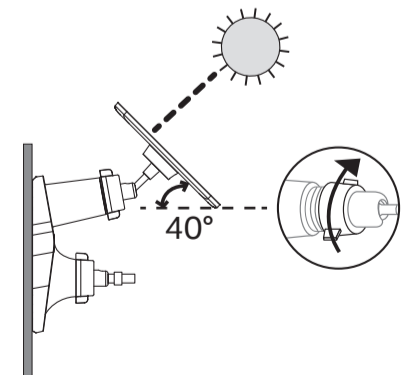

40°

6. Install Camera & Adjust Angle

Install the camera onto the bracket and adjust the camera angle as per the camera's guide.

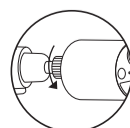

Ensure the camera is securely attached to the camera bracket by tightening the bottom screw.

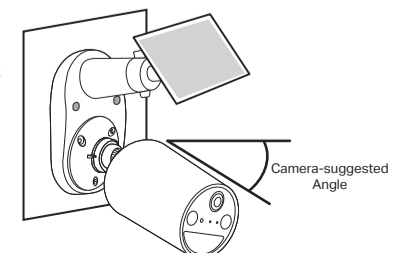

Camera-suggested Angle

Scenario 3. Mount Solar Panel and Camera KIT

03 / Connect to the Camera

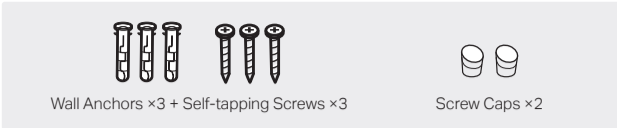
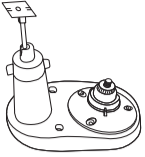

1. Drill Holes

Stick the mounting template to a solid and level wall surface. Drill three screw holes according to the template.

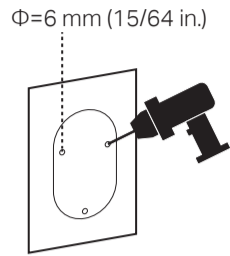

2. Mount Bracket

Insert three wall anchors into the holes and use the mounting screws to affix the solar panel bracket over the anchors. Then, insert two screw caps into the upper screw holes.

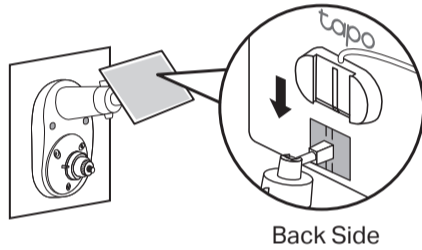
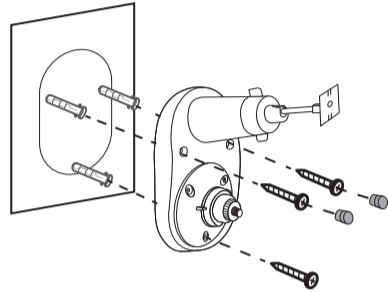
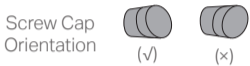

3. Install the Solar Panel

Slide the solar panel onto the mounting bracket until it clicks into place.

4. Adjust Solar Panel Angle

Loosen the adjustable screw, tilt the solar panel to adjust the angle, and then tighten the adjustable screw.

The recommended tilt angle between the panel and the horizontal ground is 35° ~ 45°.

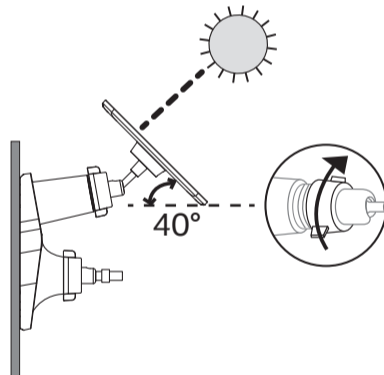

5. Install Camera & Adjust Angle

Install the camera onto the bracket and adjust the camera angle as per the camera's guide.

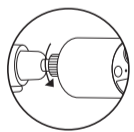

Ensure the camera is securely attached to the camera bracket by tightening the bottom screw.

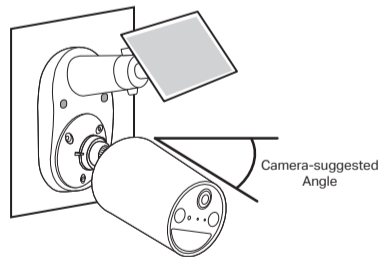

Use the appropriate waterproof gasket when connecting the solar panel to your camera. The gasket protects your camera from exposed moisture and dust that may damage the camera.

1. Install Waterproof Gasket

Insert the waterproof gasket into the camera's charging port. Ensure that the gasket is tightly sealed.

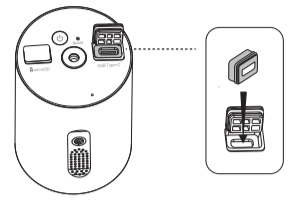

2. Power On Camera

Connect the solar panel by inserting the connector with the black ring into the charging port until snug.

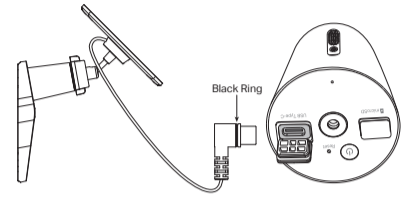

A USB adapter is required for a camera with a Micro USB charging port. Choose the appropriate Micro USB waterproof gasket for connection.

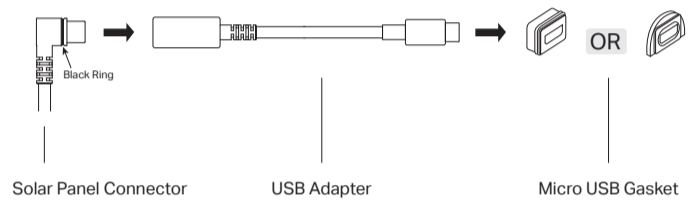

If the power cable is too short...

Extend the power cable using the provided extension cable. Insert the connector with the black ring into the extension until snug and use the appropriate gasket when connecting the solar panel to your camera.

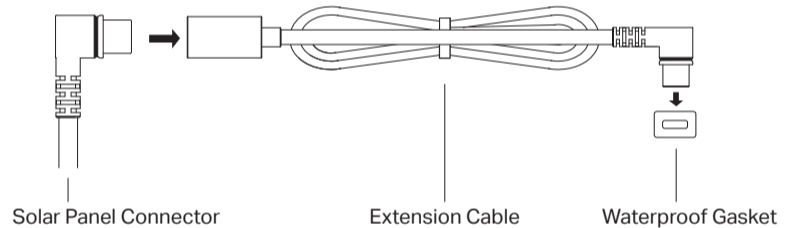

If the power cable is too long...

Use the cable zip tie provided to bundle up the excess cable. Once tightened, the zip tie cannot be easily adjusted. To release the tie, you will need to cut the zip tie.

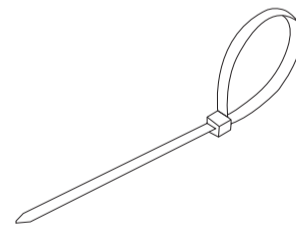

Safety Information

- Keep the device away from fire or hot environments. DO NOT immerse in water or any other liquid.
- Do not attempt to disassemble, repair, or modify the device. If you need service, please contact us.

TP-Link hereby declares that the device is in compliance with the essential requirements and other relevant provisions of directives 2014/30/EU, 2014/35/EU, 2011/65/EU and (EU)2015/863.

The original EU declaration of conformity may be found at <https://www.tapo.com/en/support/ce/>

TP-Link hereby declares that the device is in compliance with the essential requirements and other relevant provisions of the Electromagnetic Compatibility Regulations 2016 and Electrical Equipment (Safety) Regulations 2016.

The original UK declaration of conformity may be found at <https://www.tapo.com/support/ukca/>



Visit www.tapo.com/support for technical support, user guides, and more information

